



Antalya Millennium Team Cadet European Cup 2025

Türkiye, Antalya, 8-9 Mar 2025

-50 kg

Men (30)

POOL A

	MARTINOV Tsvetelin	BUL
	KHALILLI Rza	AZE
	GULUA Aleksii	GEO
	BENABDENBI Mohammad	FRA
	OMIRZHAN Zhalgas	KAZ
	KILINC Hamza	TUR
	ZHANIBEKOV Raatbek	KGZ

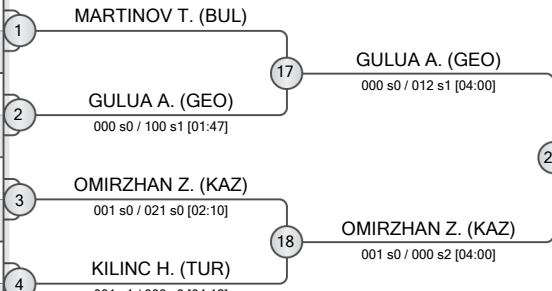

POOL B

	PERDALY Abish	KAZ
	SEN Eymen	TUR
	ZHEENBAEV Mairambek Almazbekovich	KGZ
	KURGANS Edgars	LAT
	TUNGALAG Tugskhuslen	MGL
	DVALISHVILI Arsen	GEO
	OZTUNC Tahir	TUR
	ASILBEKOV Ramis Stalbekovich	KGZ

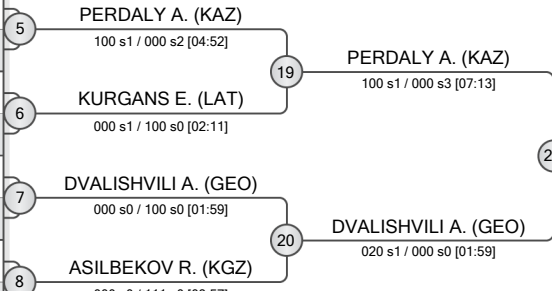

POOL C

	BOLKVADZE Saba	GEO
	OZDEMIR Muhammed Enes	TUR
	MYSSA Arman	KAZ
	VILLA Tim	FRA
	IBRAGIMOV Ratmir Ruslanovich	KGZ
	CERVINSKIS Bogdans	LAT
	GUL Ibrahim	TUR

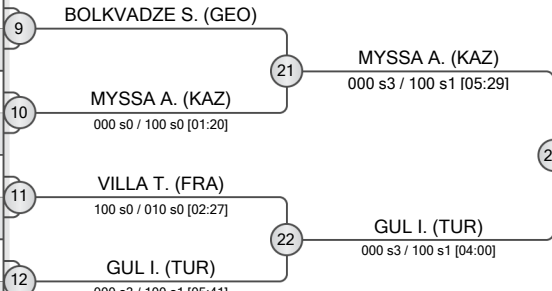

POOL D

	ALSHAMMARI Abdulwahab	KUW
	DAULETKAN Meray	KAZ
	DVALI Giorgi	GEO
	GUN Berkay	TUR
	ZEINOLLA Farkhat	KAZ
	BERDIBEKOV Marselbek	KGZ
	SEMIANTSOU Artsiom	UZB
	MYAGMAR Enkhbileg	MGL

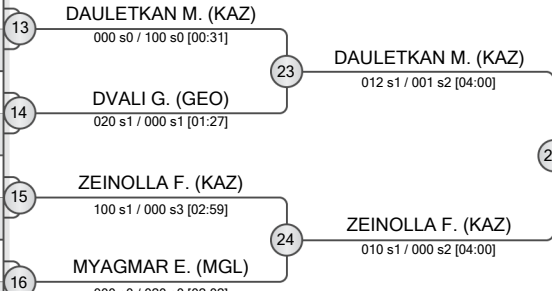

REPECHAGE

29 KHALILLI R. (AZE)	30 ASILBEKOV R. (KGZ)	31 BOLKVADZE S. (GEO)	32 DVALI G. (GEO)
33 KHALILLI R. (AZE)	34 ASILBEKOV R. (KGZ)	35 BOLKVADZE S. (GEO)	36 ZEINOLLA F. (KAZ)

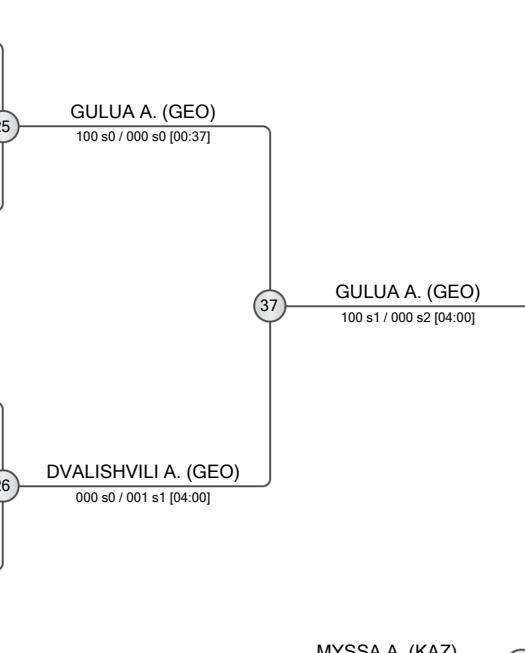
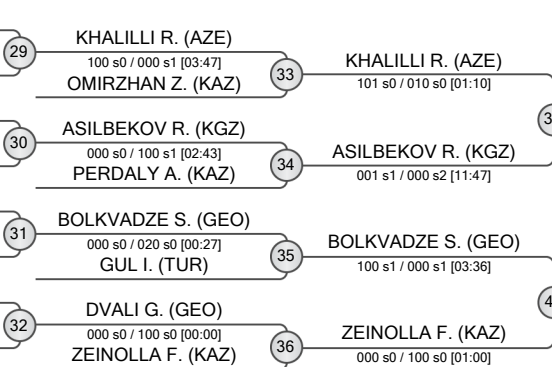

FINAL RESULTS		
1.	MYSSA Arman	KAZ
2.	GULUA Aleksii	GEO
3.	DAULETKAN Meray	KAZ
3.	ZEINOLLA Farkhat	KAZ
5.	KHALILLI Rza	AZE
7.	DVALISHVILI Arsen	GEO
7.	ASILBEKOV Ramis Stalbekovich	KGZ
7.	BOLKVADZE Saba	GEO





Antalya Millennium Team Cadet European Cup 2025

Türkiye, Antalya, 8-9 Mar 2025

-55 kg

Men (38)

POOL A

	MAMETOV Seitzhan	KAZ	1	MAMETOV S. (KAZ)	
	SHIKHIZADA Nijat	AZE	2	SHIKHIZADA N. (AZE)	
	ALRAMZI Hasan	KUW	3	IUNUSOV Bahridin	KGZ
	IUNUSOV Bahridin	KGZ	3	IUNUSOV B. (KGZ)	
	CANPOLAT Osman	TUR	4	CANPOLAT O. (TUR)	
	AMANGELDY Beknur	KAZ	5	AMANGELDY B. (KAZ)	
	KOTOLASHVILI Tamaz	GEO	6	ANARBAEV S. (KGZ)	
	ANARBAEV Salman	KGZ	6	ANARBAEV S. (KGZ)	
	HAROUN Almashni	JOR	7	HAROUN A. (JOR)	
	MONTSIK Yauheni	IJF	8	MONTSIK Y. (IJF)	

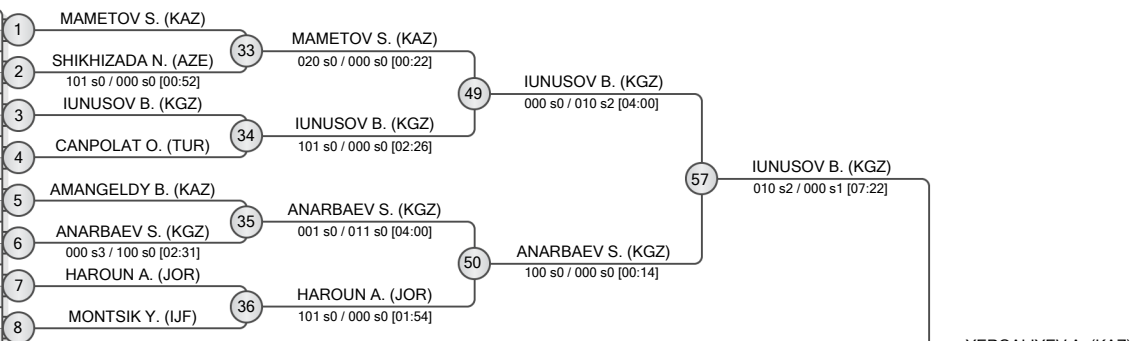

POOL B

	PUREVTSEREN Altantsooj	MGL	9	PUREVTSEREN A. (MGL)
	GABIT Rassulkhan	KAZ	10	GABIT R. (KAZ)
	DUI SHENOV Beksultan	KGZ	11	TUNC D. (TUR)
	TUNC Dogukan	TUR	11	TUNC D. (TUR)
	LACIKA Silvio	SVK	12	LACIKA S. (SVK)
	GALENKOV Ivo	BUL	13	GALENKOV I. (BUL)
	YERGALIYEV Aslan	KAZ	14	YERGALIYEV A. (KAZ)
	HUSEYNLI Jeyhun	AZE	15	HUSEYNLI J. (AZE)
	PALELASHVILI Nikoloz	GEO	16	PALELASHVILI N. (GEO)

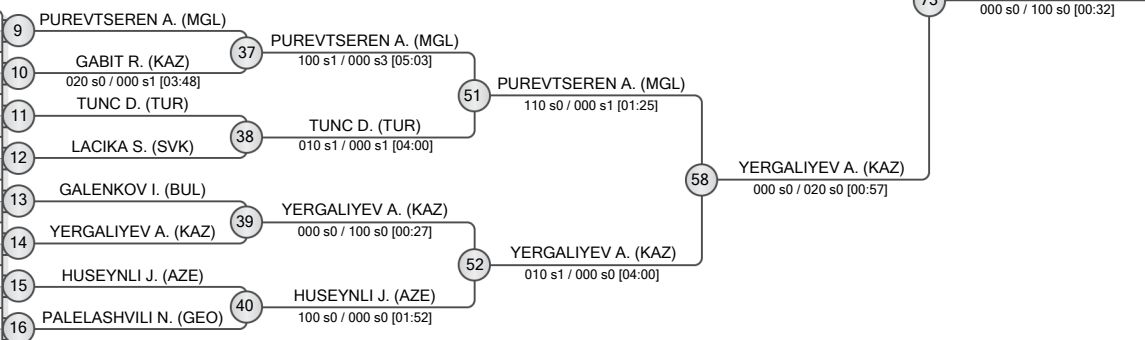

POOL C

	MALDONADO Esteban	ARG	17	MALDONADO E. (ARG)
	MEGRELISHVILI Nika	GEO	18	ASIRLI B. (TUR)
	ASIRLI Bilal Efe	TUR	18	ASIRLI B. (TUR)
	CHEGINI Amirhossein	IRI	19	CHEGINI A. (IRI)
	HRISTOV Emo	BUL	20	HRISTOV E. (BUL)
	GASIMZADE Rustam	AZE	21	GASIMZADE R. (AZE)
	YELEMES Arsen	KAZ	22	YELEMES A. (KAZ)
	BOKONOV Nurbol	KGZ	23	BOKONOV N. (KGZ)
	YAVUZ Mehmet Yakup	TUR	24	YAVUZ M. (TUR)

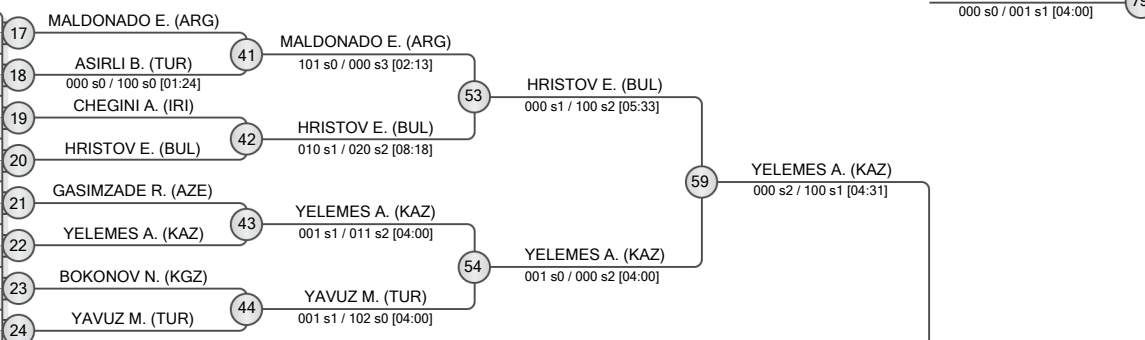

POOL D

	ALRAMZI Ali	KUW	25	ALRAMZI A. (KUW)
	GUR Ramazan Aykut	TUR	26	KASAPI R. (KOS)
	KASAPI Riad	KOS	26	KASAPI R. (KOS)
	ABDYLDAEV Sanzhar	KGZ	27	ABDYLDAEV S. (KGZ)
	ABDIMANAP Akezhan	KAZ	28	ABDIMANAP A. (KAZ)
	GIVISHVILI Nikoloz	GEO	29	GIVISHVILI N. (GEO)
	BEKISHEV Bekdaulet	KAZ	30	RUSTAMLI M. (AZE)
	RUSTAMLI Mahammad	AZE	30	RUSTAMLI M. (AZE)
	KANDRATOVICH Hleb	IJF	31	KANDRATOVICH H. (IJF)
	ARLIEV Muslim	KGZ	32	ARLIEV M. (KGZ)

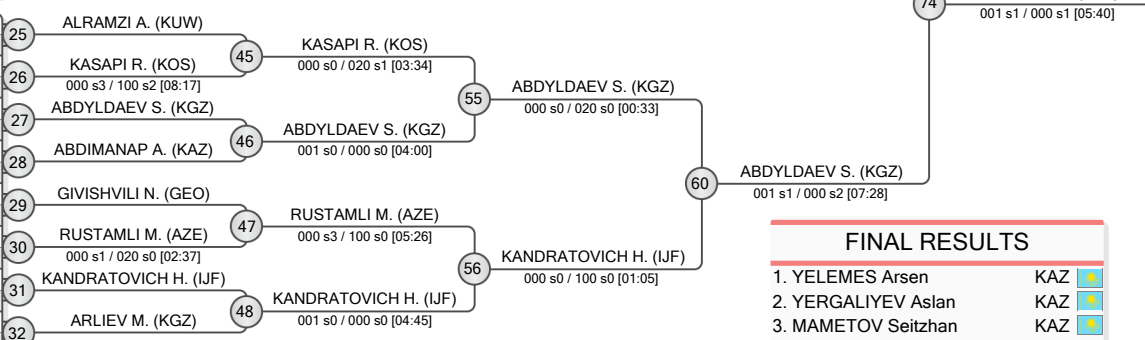

FINAL RESULTS		
1.	YELEMES Arsen	KAZ
2.	YERGALIYEV Aslan	KAZ
3.	MAMETOV Seitzhan	KAZ
3.	ABDIMANAP Akezhan	KAZ
5.	ABDYLDAEV Sanzhar	KGZ
7.	IUNUSOV Bahridin	KGZ
7.	PUREVTSEREN Altantsooj	MGL
7.	GASIMZADE Rustam	AZE

REPECHAGE

CANPOLAT O. (TUR)	61	CANPOLAT O. (TUR)	65	MAMETOV S. (KAZ)	69	MAMETOV S. (KAZ)
GALENKOV I. (BUL)	62	GALENKOV I. (BUL)	66	GALENKOV I. (BUL)	70	PUREVTSEREN A. (MGL)
GASIMZADE R. (AZE)	63	GASIMZADE R. (AZE)	67	GASIMZADE R. (AZE)	71	GASIMZADE R. (AZE)
ABDIMANAP A. (KAZ)	64	ABDIMANAP A. (KAZ)	68	ABDIMANAP A. (KAZ)	72	ABDIMANAP A. (KAZ)

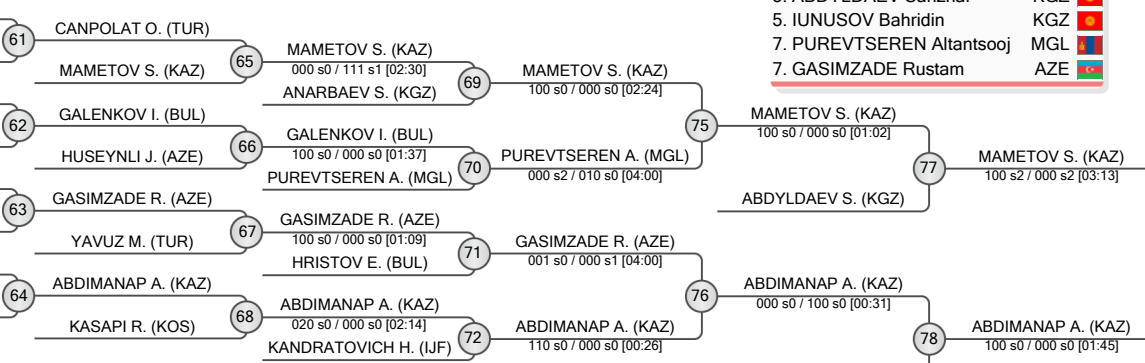



Antalya Millennium Team Cadet European Cup 2025

Türkiye, Antalya, 8-9 Mar 2025

-60 kg

Men (44)

POOL A

1	ALKANDARI Khaled KUW	1	ALKANDARI K. (KUW)
2	OZCELIK Muhammet Cagri TUR	2	OZCELIK M. (TUR)
3	GABAYEV Yacine BEL	3	GABAYEV Y. (BEL)
4	OZTEKIN Emir TUR	4	OZTEKIN E. (TUR)
5	ZHUSUPOV Islam KGZ	5	ZHUSUPOV I. (KGZ)
6	BATBAATAR Sodmandakh MGL	6	BATBAATAR S. (MGL)
7	ISAYEV Nemat AZE	7	ISAYEV N. (AZE)
8	ZHEENBEKOV Aidamir KGZ	8	ZHEENBEKOV A. (KGZ)
9	KALDARBEKOV Temirlan KGZ	9	KALDARBEKOV T. (KGZ)
10	KURT Guven TUR	10	KURT G. (TUR)
11	YELUBAYEV Yeran KAZ	11	YELUBAYEV Y. (KAZ)

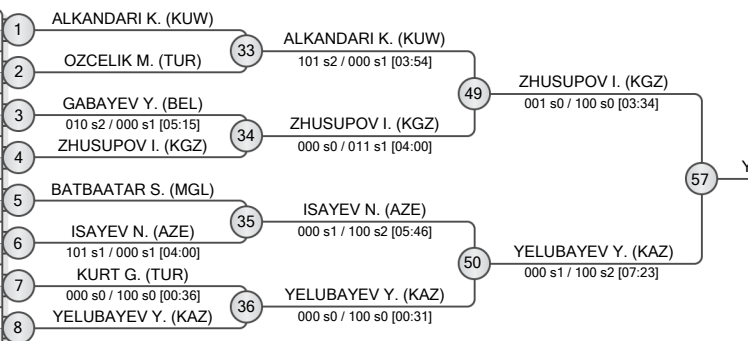

POOL B

9	KABDESHOV Bakdaulet KAZ	9	KABDESHOV B. (KAZ)
10	TODOROV Vladimir BUL	10	TODOROV V. (BUL)
11	MUKHAMBETOV Beksultan KGZ	11	MUKHAMBETOV B. (KGZ)
12	TOPAL Yigit TUR	12	TOPAL Y. (TUR)
13	HUSEYNLI Emil AZE	13	HUSEYNLI E. (AZE)
14	KUZNETSOV Roman IJF	14	KUZNETSOV R. (IJF)
15	ESENBOGA Can Emirhan TUR	15	ESENBOGA C. (TUR)
16	ASSYLBEKULY Damir KAZ	16	ASSYLBEKULY D. (KAZ)
17	ATABAEV Abirkhan Ulanbekovich KGZ	17	ATABAEV A. (KGZ)
18	BERADZE Giorgi GEO	18	BERADZE G. (GEO)
19	GUNUGUR Yigit Erdal TUR	19	GUNUGUR Y. (TUR)

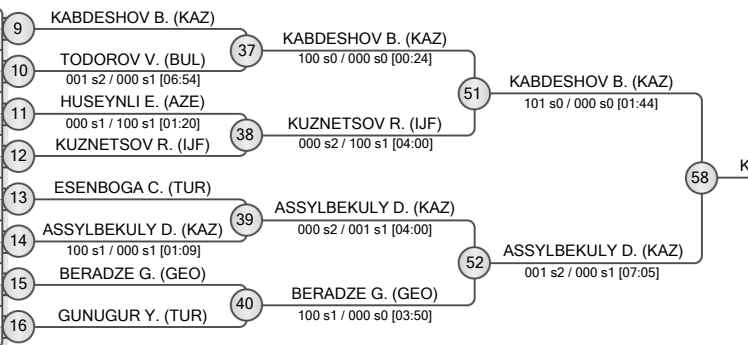

POOL C

17	TCHIBERASHVILI Vakhtangi GEO	17	TCHIBERASHVILI V. (GEO)
18	NASRULLAYEV Najaf AZE	18	NASRULLAYEV N. (AZE)
19	BALDZENKA Artsiom IJF	19	BALDZENKA A. (IJF)
20	DZHUMASHEV Omurbek Kenzhebekovich KGZ	20	DZHUMASHEV O. (KGZ)
21	TOK Berat TUR	21	TOK B. (TUR)
22	TEKIN Suleyman TUR	22	TEKIN S. (TUR)
23	BATYRGALI Yernur KAZ	23	BATYRGALI Y. (KAZ)
24	TSEDENBAL Jargalantbayar MGL	24	TSEDENBAL J. (MGL)
25	AZDANIN Ashraf JOR	25	AZDANIN A. (JOR)
26	ABDYKASYMOV Baiel KGZ	26	ABDYKASYMOV B. (KGZ)
27	UCAR Alperen TUR	27	UCAR A. (TUR)

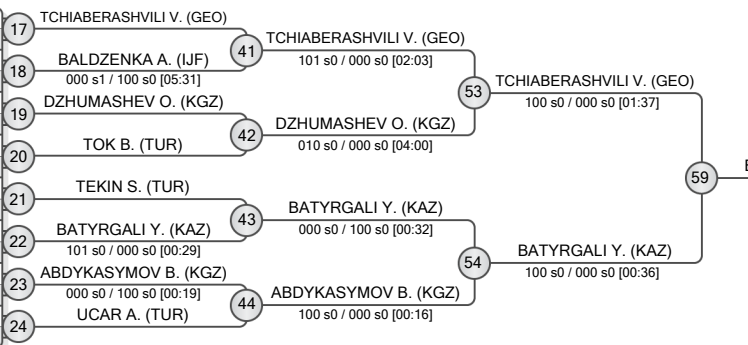

POOL D

25	CRUCES Lautaro ARG	25	CRUCES L. (ARG)
26	MEREKLISHVILI Levan GEO	26	MEREKLISHVILI L. (GEO)
27	TASHTANBEKOV Umar KGZ	27	TASHTANBEKOV U. (KGZ)
28	ABAY Zhanadil KAZ	28	ABAY Z. (KAZ)
29	TUMONBAEV Marsel KGZ	29	TUMONBAEV M. (KGZ)
30	BILGE Enes TUR	30	BILGE E. (TUR)
31	DIMITROV Samuil BUL	31	DIMITROV S. (BUL)
32	GAYIBOV Royal AZE	32	GAYIBOV R. (AZE)
33	SAYIK Kerem TUR	33	SAYIK K. (TUR)
34	ADYLBKOV Alymbek KGZ	34	ADYLBKOV A. (KGZ)
35	GASHI Milot KOS	35	GASHI M. (KOS)

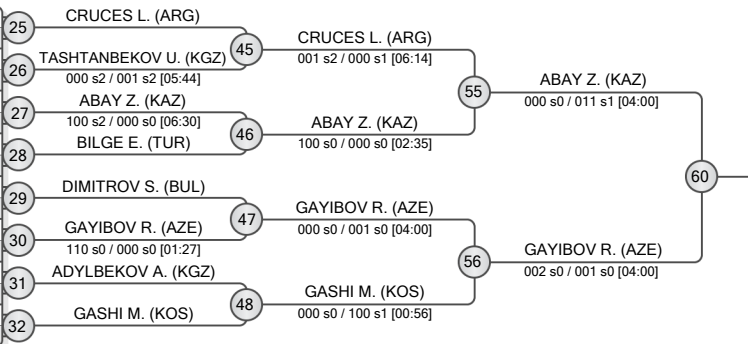

REPECHAGE

61	KURT G. (TUR)	61	KURT G. (TUR)
62	TODOROV V. (BUL)	62	TODOROV V. (BUL)
63	TSEDENBAL J. (MGL)	63	TSEDENBAL J. (MGL)
64	TEKIN S. (TUR)	64	TEKIN S. (TUR)
65	SAYIK K. (TUR)	65	SAYIK K. (TUR)
66	DIMITROV S. (BUL)	66	DIMITROV S. (BUL)

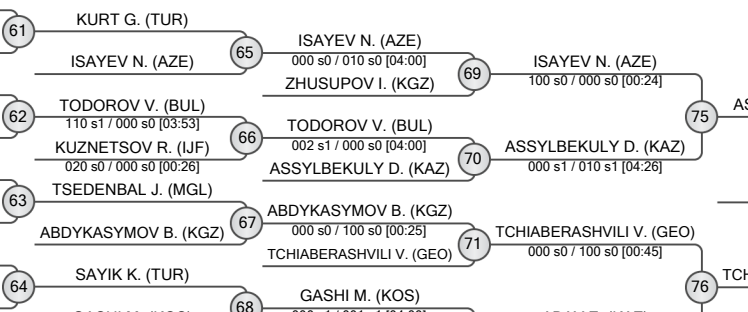

FINAL RESULTS

- KABDESHOV Bakdaulet KAZ
- BATYRGALI Yernur KAZ
- GAYIBOV Royal AZE
- TCHIBERASHVILI Vakhtangi GEO
- ASSYLBEKULY Damir KAZ
- YELUBAYEV Yeran KAZ
- ISAYEV Nemat AZE
- ABAY Zhanadil KAZ





Antalya Millennium Team Cadet European Cup 2025

Türkiye, Antalya, 8-9 Mar 2025

-66 kg

Men (37)

POOL A

	HADZI-VELJKOVIC Nikola	CRO
	MAMMADOV Kanan	AZE
	ONAY Numan	TUR
	ZHYLKAIDAR Mukhammedali	KAZ
	BATTUGS Badral	MGL
	BREGVADZE Nika	GEO
	PINAR Omer Faruk	TUR
	BELOGLAZOV V Vladimirs	LAT
	NIKOLOV Preslav	BUL

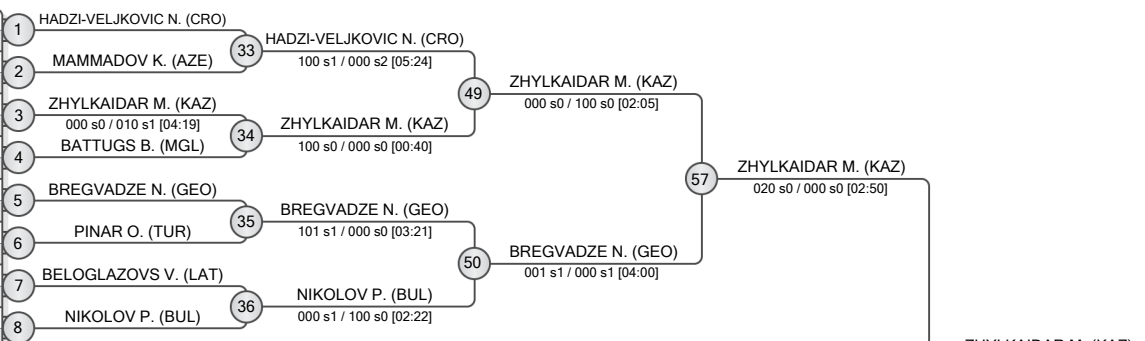

POOL B

	ABBASOV Yusif	AZE
	EKMEKCI Emirhan	TUR
	KAIRGALI Rolan	KAZ
	ABDIRASHITOV Baiel Sanzharbekovich	KGZ
	HOMKA Eriks	LAT
	DUISSENBAY Nurdaulet	KAZ
	LAVRINJOV Volodomor	EST
	KEDELASHVILI Koba	GEO
	KARIMOV Abdullah	AZE

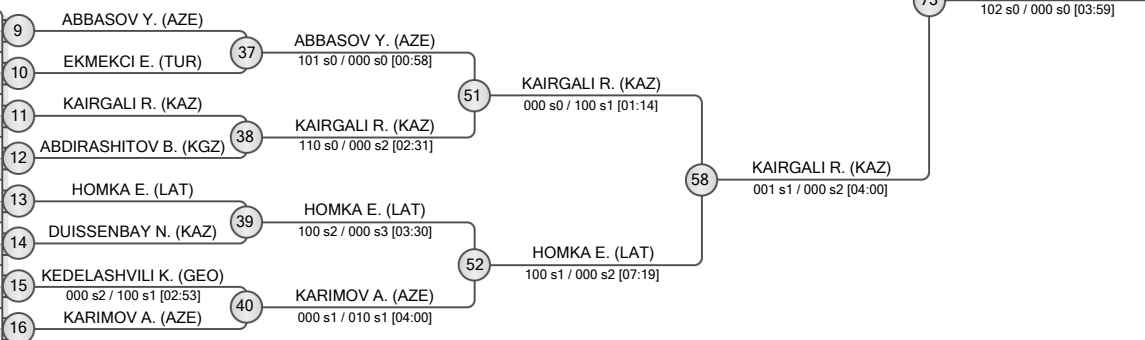

POOL C

	SAHIBZADE Fakhri	AZE
	POLAT Sivan Umut	TUR
	TOMASIC Mateo	CRO
	PABERZIS Andrejs	LAT
	ABDRAIMOV Narmatbek	KGZ
	BABUTSIDZE Giorgi	GEO
	BOZKURT Mehmet Muta	TUR
	YERKEN Bekali	KAZ
	HAJIYEV Alimohsun	AZE

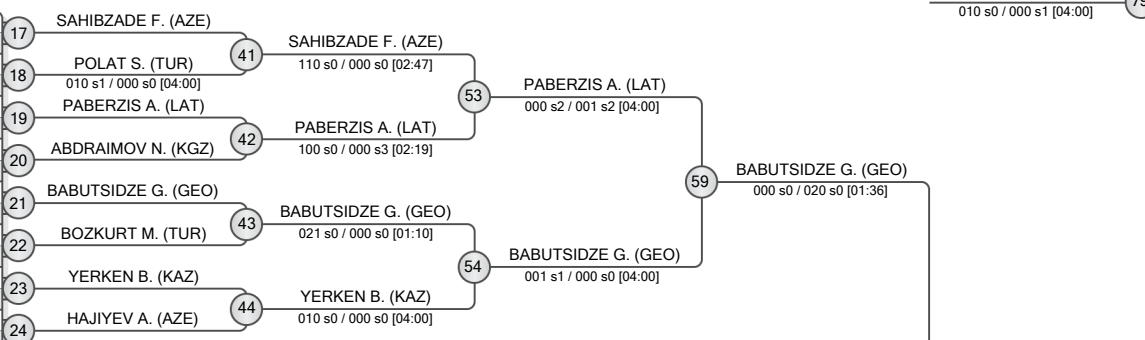

POOL D

	BABACHEV Stiliyan	BUL
	YILMAZ Tahsin Efe	TUR
	BAKTYGALI Zamanbek	KAZ
	HUSEYNOV Huseyn	AZE
	HLADKIKH Arseni	IJF
	ZUGICKIS Markuss	LAT
	TURYSBEK Yerzhanibek	KAZ
	BOLOTBEKOV Arsen	KGZ
	ABDULOV Umid	AZE
	GIBRADZE Irakli	GEO

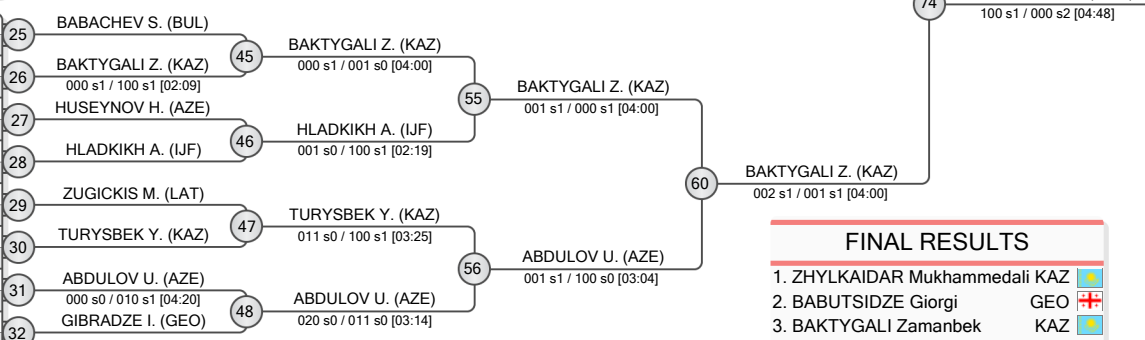

FINAL RESULTS	
1.	ZHYLKAIDAR Mukhammedali KAZ
2.	BABUTSIDZE Giorgi GEO
3.	BAKTYGALI Zamanbek KAZ
3.	KAIRGALI Rolan KAZ
5.	HADZI-VELJKOVIC Nikola CRO
5.	ABDULOV Umid AZE
7.	HOMKA Eriks LAT
7.	YERKEN Bekali KAZ

REPECHAGE

	ONAY N. (TUR)	61
	BATTUGS B. (MGL)	62
	ABDIRASHITOV B. (KGZ)	63
	BOZKURT M. (TUR)	64
	YILMAZ T. (TUR)	65
	BABACHEV S. (BUL)	66

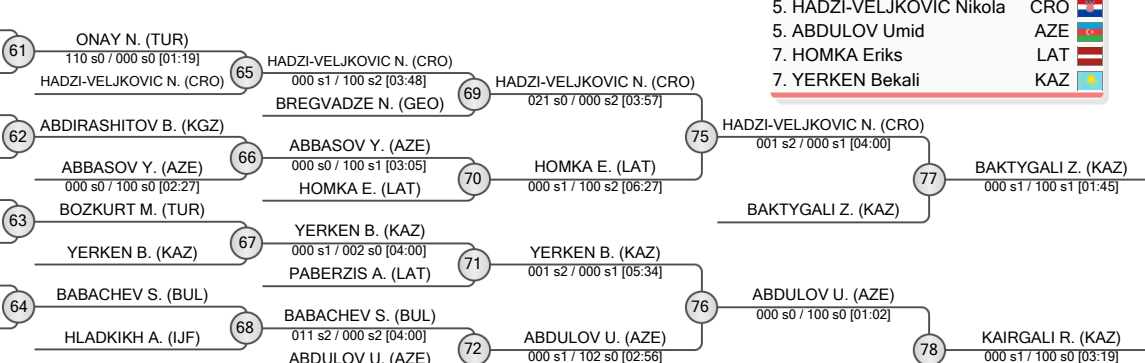



Antalya Millennium Team Cadet European Cup 2025

Türkiye, Antalya, 8-9 Mar 2025

-73 kg

Men (24)

POOL A

	BATBUYAN Dalaitseren	MGL
	SHAKHMARDANULY Zhakhanshakh	KAZ
	SENGUR Bahadir Efe	TUR
	OSMONOV Eldar	KGZ
	ALEINIKOV Alexandr	IJF
	ARSLAN Ibrahim Ethem	TUR

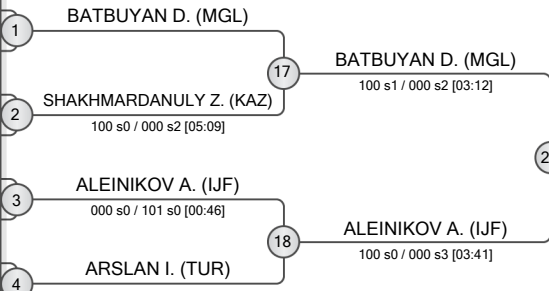

POOL B

	ULAMJLAL Odbaatar	MGL
	ERZAMAN Kris	TUR
	HASANLI Aykhan	AZE
	BAYARJAVKHLAN Temuulen	MGL
	YILDIRIM Emirhan	TUR
	SHAMDAULET Alinur	KAZ

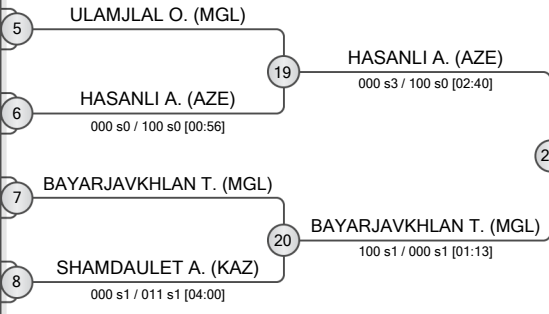

POOL C

	SEIFIL Dauletkerey	KAZ
	MARASULOV Kaniet	KGZ
	ERTEM Huseyin	TUR
	ZHUMABAY Adil	KAZ
	GENC Eren	TUR
	ARSU Ozgur Derin	TUR

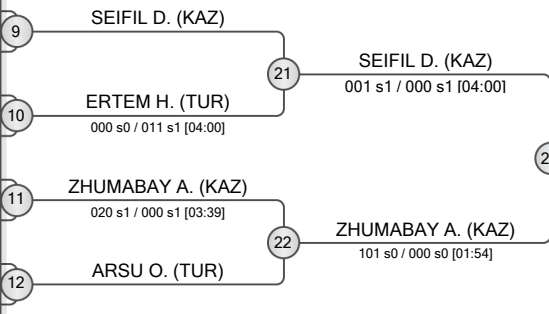

POOL D

	KYDYRBAY Myrzatay	KAZ
	BAS Bedirhan	TUR
	NAZAR Yusuf	AZE
	BYAMBADORJ Gerelt-Och	MGL
	ISAKOV Baiel	KGZ
	YELKENCI Emin Levent	TUR

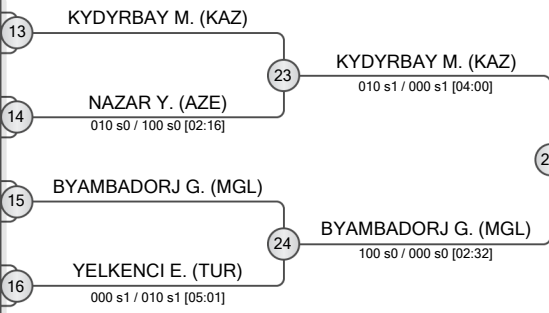

FINAL RESULTS		
1.	KYDYRBAY Myrzatay	KAZ
2.	HASANLI Aykhan	AZE
3.	BAYARJAVKHLAN Temuulen	MGL
3.	SEIFIL Dauletkerey	KAZ
5.	ZHUMABAY Adil	KAZ
5.	BATBUYAN Dalaitseren	MGL
7.	ALEINIKOV Alexandr	IJF
7.	BYAMBADORJ Gerelt-Och	MGL

REPECHAGE

29	SHAKHMARDANULY Z. (KAZ)
30	ULAMJLAL O. (MGL)
31	ARSU O. (TUR)
32	NAZAR Y. (AZE)
33	ALEINIKOV A. (IJF)
34	BAYARJAVKHLAN T. (MGL)
35	SEIFIL D. (KAZ)
36	BYAMBADORJ G. (MGL)

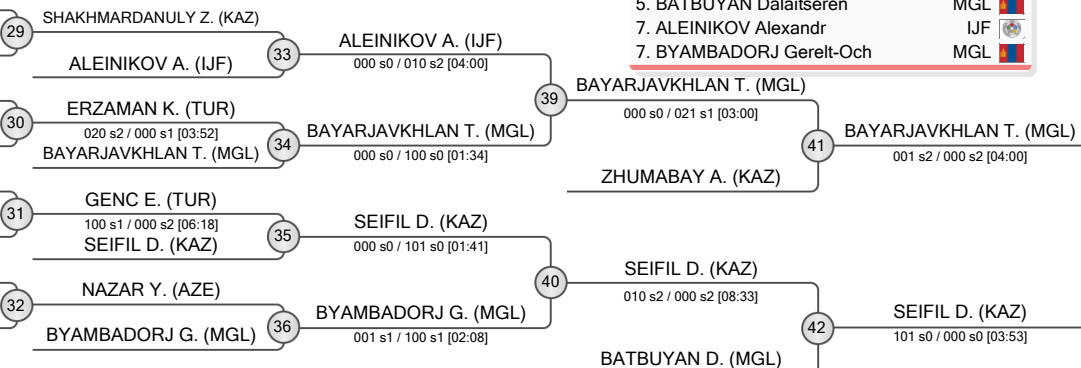



Antalya Millennium Team Cadet European Cup 2025

Türkiye, Antalya, 8-9 Mar 2025

-81 kg

Men (23)

POOL A

	BOUQAMMAZ Anas	KUW	1	BOUQAMMAZ A. (KUW)
	KURBANOV Dastan	KAZ	2	KURBANOV D. (KAZ)
	IMANALYEV Nuradil	KGZ	3	ABDULLAYEV T. (AZE)
	ABDULLAYEV Tunar	AZE	3	ABDULLAYEV T. (AZE)
	CIRAH Alim	TUR	4	CIRAH A. (TUR)

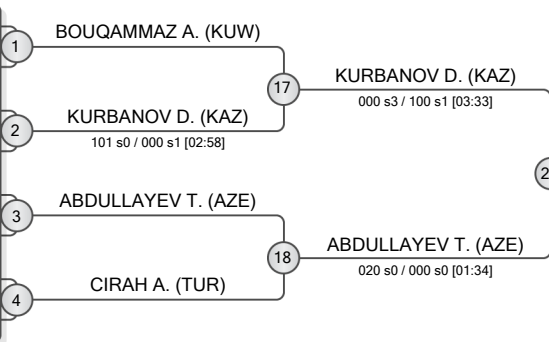

POOL B

	DIMITROV Hristo	BUL	5	DIMITROV H. (BUL)
	CEBECI Yagiz Efe	TUR	6	SAIKALY D. (LBN)
	SAIKALY Diego	LBN	6	SAIKALY D. (LBN)
	BOUNTANIOTIS Georgios	GRE	7	BOUNTANIOTIS G. (GRE)
	BOLATBEK YerasyI	KAZ	8	BOLATBEK Y. (KAZ)
	YILDIRIM Mustafa Beyazit	TUR	8	BOLATBEK Y. (KAZ)

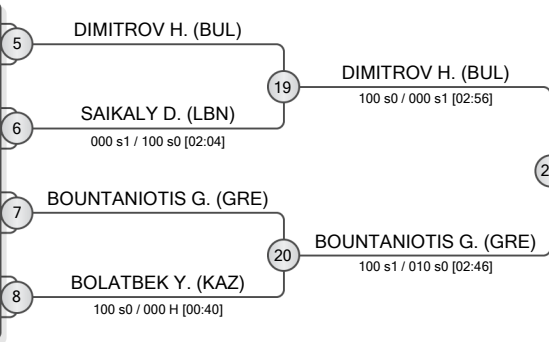

POOL C

	KULLO Tits	LAT	9	KULLO T. (LAT)
	AYDOGU Mehmet Ali	TUR	10	ABBASALI M. (AZE)
	ABBASALI Mahammad	AZE	10	ABBASALI M. (AZE)
	SIMONOV Aleksandr	KGZ	11	SIMONOV A. (KGZ)
	CELIK Emir Musap	TUR	12	CELIK E. (TUR)
	KARAKLIDIS Gkiorgki	GRE	12	CELIK E. (TUR)

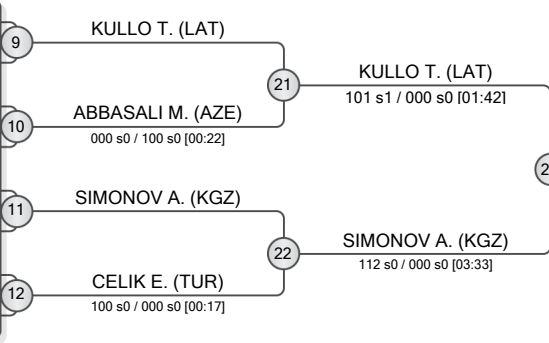

POOL D

	ALENEZI Turkey	KUW	13	ALENEZI T. (KUW)
	AKHUNDOV Omar	AZE	14	AKHUNDOV O. (AZE)
	DINCER Yigit	TUR	15	AYDIN A. (TUR)
	AYDIN Arda	TUR	15	AYDIN A. (TUR)
	TEMIROV Artur	KGZ	16	LATIPBEK S. (KAZ)
	LATIPBEK Shyngdar	KAZ	16	LATIPBEK S. (KAZ)

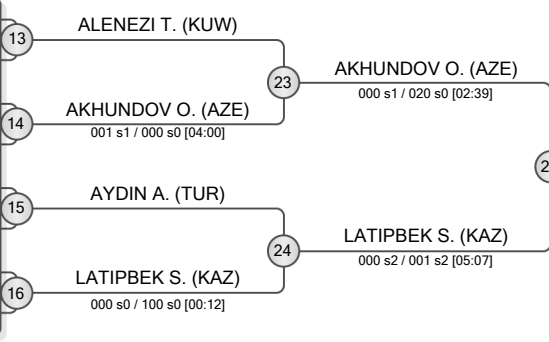

REPECHAGE

	CIRAH A. (TUR)	29	CIRAH A. (TUR)	33	KURBANOV D. (KAZ)
	SAIKALY D. (LBN)	30	SAIKALY D. (LBN)	34	SAIKALY D. (LBN)
	CELIK E. (TUR)	31	CELIK E. (TUR)	35	KULLO T. (LAT)
	DINCER Y. (TUR)	32	DINCER Y. (TUR)	36	LATIPBEK S. (KAZ)
	ALENEZI T. (KUW)	32	LATIPBEK S. (KAZ)	36	LATIPBEK S. (KAZ)

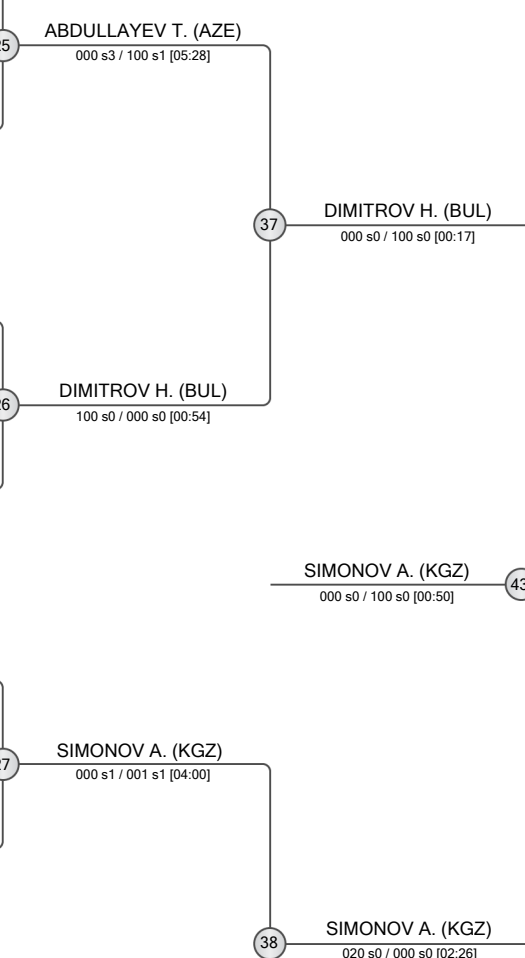
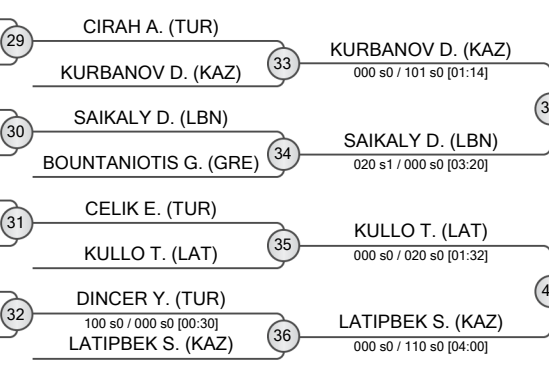

FINAL RESULTS

1.	SIMONOV Aleksandr	KGZ	
2.	DIMITROV Hristo	BUL	
3.	SAIKALY Diego	LBN	
3.	KULLO Tits	LAT	
5.	AKHUNDOV Omar	AZE	
5.	ABDULLAYEV Tunar	AZE	
7.	KURBANOV Dastan	KAZ	
7.	LATIPBEK Shyngdar	KAZ	





Antalya Millennium Team Cadet European Cup 2025

Türkiye, Antalya, 8-9 Mar 2025

-90 kg

Men (22)

POOL A

QUINTEROS Tomas	ARG	1	QUINTEROS T. (ARG)
KARASU Efe	TUR	2	KARASU E. (TUR)
LKHAGVADORJ Khulegu	MGL	3	LKHAGVADORJ K. (MGL)
SEZER Muzaffer Bugra	TUR	4	RIZABEK A. (KAZ)
RIZABEK Aldiyar	KAZ		000 s0 / 020 s0 [02:38]

POOL B

KOSTELIDIS Angelos	GRE	5	KOSTELIDIS A. (GRE)
SALIEV Alikhan	KGZ	6	SALIEV A. (KGZ)
RIKHARD Damir	KAZ		020 s1 / 000 s0 [03:47]
ALDAIHANI Abdullah	KUW	7	ALDAIHANI A. (KUW)
KHAZRIYEV Amir	AZE	8	KHAZRIYEV A. (AZE)
ITAH Alper Kivanc	TUR		020 s0 / 000 s1 [00:54]

POOL C

TOKTAR Batyrzhan	KAZ	9	TOKTAR B. (KAZ)
KARABASLI Doruk	TUR	10	NIKBIN M. (IRI)
NIKBIN Mahdi	IRI		000 s3 / 100 s0 [05:48]
HUSEYNOV Said	AZE	11	HUSEYNOV S. (AZE)
AYDILEK Muhammed Hamza	TUR	12	AYDILEK M. (TUR)

POOL D

AITMATOV Beksultan	KGZ	13	AITMATOV B. (KGZ)
OZEL Yusuf	TUR	14	OZEL Y. (TUR)
GUNDUZ Celal	TUR		100 s0 / 000 s1 [03:08]
ABIBULA Yerassyl	KAZ	15	ABIBULA Y. (KAZ)
YALIN Ruzgar	TUR	16	KIRYLAU A. (IJF)
KIRYLAU Arseni	IJF		000 s1 / 022 s0 [01:51]

REPECHAGE

KARASU E. (TUR)	29	KARASU E. (TUR)	33	RIZABEK A. (KAZ)
SALIEV A. (KGZ)	30	SALIEV A. (KGZ)	34	SALIEV A. (KGZ)
NIKBIN M. (IRI)	31	NIKBIN M. (IRI)	35	HUSEYNOV S. (AZE)
YALIN R. (TUR)		HUSEYNOV S. (AZE)		000 s3 / 110 s0 [00:43]
ABIBULA Y. (KAZ)	32	ABIBULA Y. (KAZ)	36	ABIBULA Y. (KAZ)
		OZEL Y. (TUR)		100 s0 / 000 s0 [02:40]

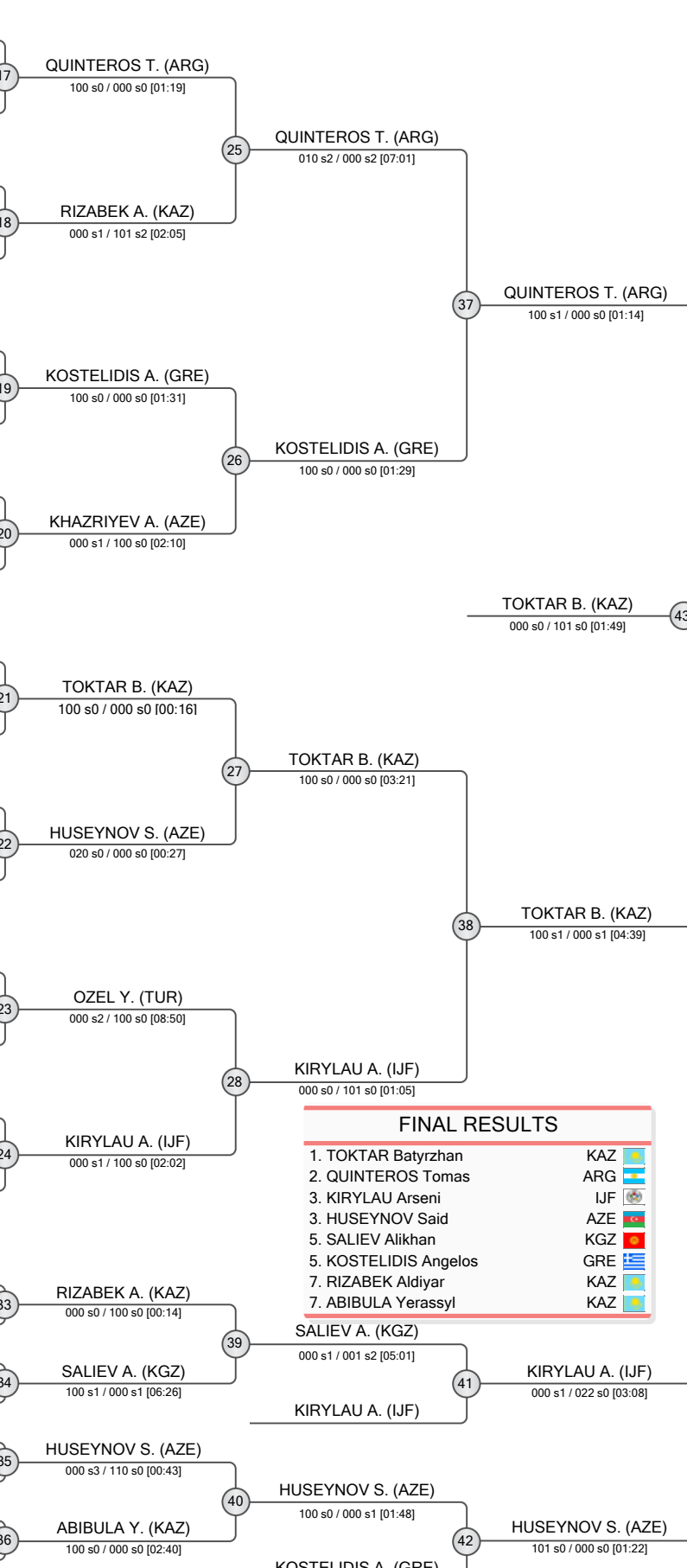



Antalya Millennium Team Cadet European Cup 2025

Türkiye, Antalya, 8-9 Mar 2025

+ 90 kg

Men (21)

POOL A

	NOVAKOVIC Petar	SRB	1	NOVAKOVIC P. (SRB)
	RUSLANULY Arslan	KAZ	2	RUSLANULY A. (KAZ)
	KAMAL Arda	TUR		011 s1 / 000 s0 [04:00]
	MASIMOV Javidan	AZE	3	MASIMOV J. (AZE)
	JUMABAY Yerdaulet	KAZ		
	USTUNDAG Samet	TUR	4	JUMABAY Y. (KAZ)
				100 s1 / 000 s1 [01:28]

POOL B

	BANAEIAN TOLKI Mohammadpouria	IRI	5	BANAEIAN TOLKI M. (IRI)
	KARADAG Haci Mustafa	TUR	6	KARADAG H. (TUR)
	NIKOLAIDIS Nikolaos	GRE	7	NIKOLAIDIS N. (GRE)
	SOYHAN Kerem Recayi	TUR		
	MAKSOTULY Ali	KAZ	8	MAKSOTULY A. (KAZ)
				000 s0 / 110 s0 [02:49]

POOL C

	STIVENSON Arthur	CAN	9	STIVENSON A. (CAN)
	ESEN Ali Ihsan	TUR	10	ESEN A. (TUR)
	ZHAUDINOV Adilzhan	KAZ	11	ZHAUDINOV A. (KAZ)
	SAGLAMCELIK Ibrahim	TUR		
	FARZALIYEV Elshan	AZE	12	FARZALIYEV E. (AZE)
				000 s1 / 100 s1 [02:51]

POOL D

	ABALAKI Ioane	GEO	13	ABALAKI I. (GEO)
	BAZARKATOV Yeraly	KAZ	14	BAZARKATOV Y. (KAZ)
	ALOB Aidan Ahmad	KUW	15	ALOB Aidan A. (KUW)
	MARKOV Nikola	BUL		
	KONDI Alperen	TUR	16	MARKOV N. (BUL)
				010 s1 / 001 s1 [04:00]

REPECHAGE

	USTUNDAG S. (TUR)			MASIMOV J. (AZE)			
			29	010 s1 / 021 s0 [01:46]			
	MASIMOV J. (AZE)			RUSLANULY A. (KAZ)			
				001 s0 / 100 s1 [03:24]			
	KARADAG H. (TUR)		30	NIKOLAIDIS N. (GRE)			
				000 s0 / 100 s0 [00:23]			
	FARZALIYEV E. (AZE)		31	FARZALIYEV E. (AZE)			
				100 s1 / 000 s0 [03:36]			
	BAZARKATOV Y. (KAZ)		32	MARKOV N. (BUL)			
				000 s1 / 100 s0 [02:10]			
	MARKOV N. (BUL)		36	JUMABAY Y. (KAZ)			
				000 s1 / 100 s1 [02:49]			

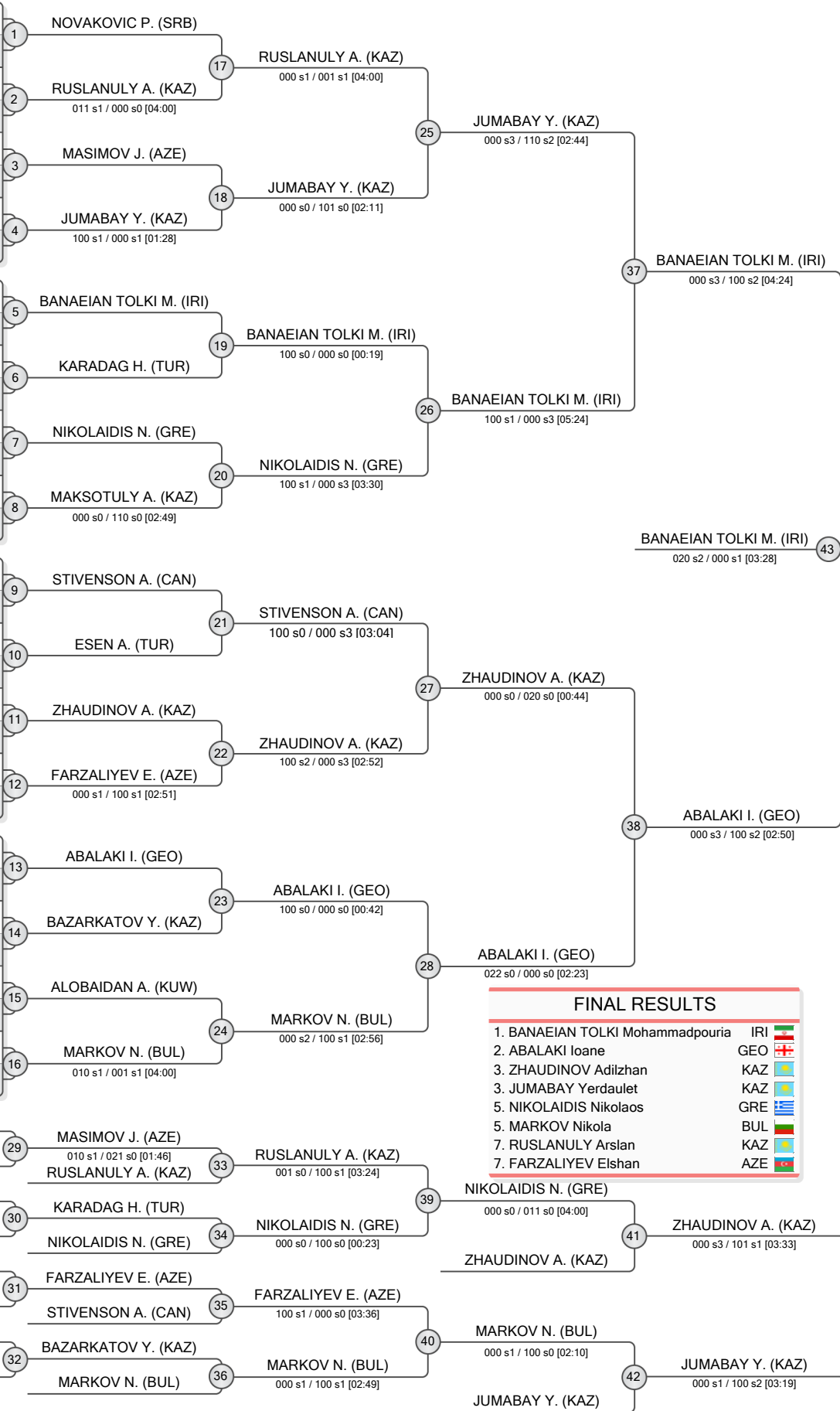

FINAL RESULTS

- BANAEIAN TOLKI Mohammadpouria IRI
- ABALAKI Ioane GEO
- ZHAUDINOV Adilzhan KAZ
- JUMABAY Yerdaulet KAZ
- NIKOLAIDIS Nikolaos GRE
- MARKOV Nikola BUL
- RUSLANULY Arslan KAZ
- FARZALIYEV Elshan AZE





Antalya Millennium Team Cadet European Cup 2025

Türkiye, Antalya, 8-9 Mar 2025

-40 kg

Women (13)

POOL A

	COSKUN Busra Ceylin	TUR
	BAYARZUL Khulan	MGL
	SALMANOVA Sunay	AZE

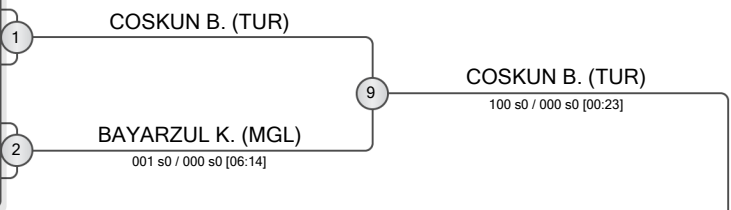

POOL B

	TOKMAK Havva Sena	TUR
	ZHANAKHMET Adiya	KAZ
	YILMAZTURK Yagmur	TUR
	RZAZADE Zahra	AZE

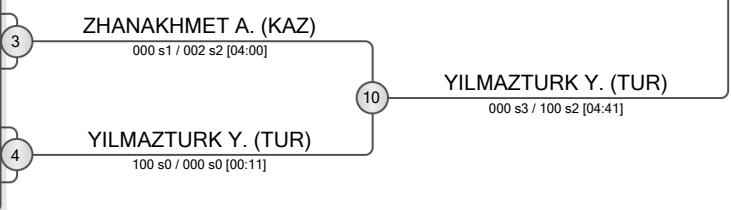

POOL C

	PEETERS Fenne	BEL
	YUKSEL Sema Nur	TUR
	YILDIRIM Ahsen	TUR

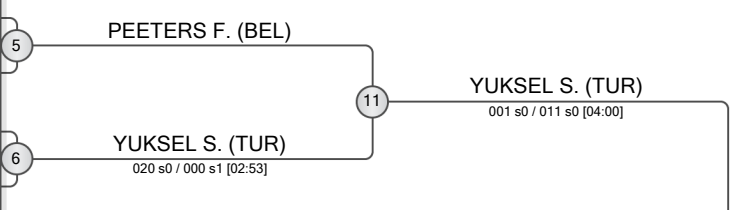

POOL D

	PRYAKHINA Ulyana	KAZ
	BASAK Vuslat	TUR
	HUSEYNOVA Madina	AZE

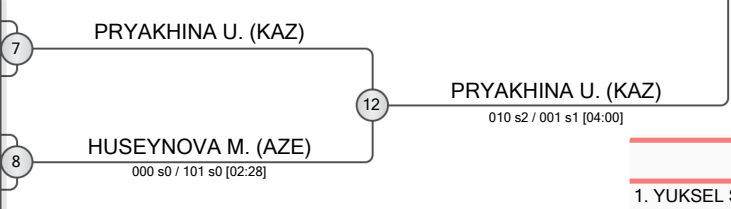

REPECHAGE

BAYARZUL K. (MGL)	13
RZAZADE Z. (AZE)	14
ZHANAKHMET A. (KAZ)	14
YILDIRIM A. (TUR)	15
PEETERS F. (BEL)	15
HUSEYNOVA M. (AZE)	16

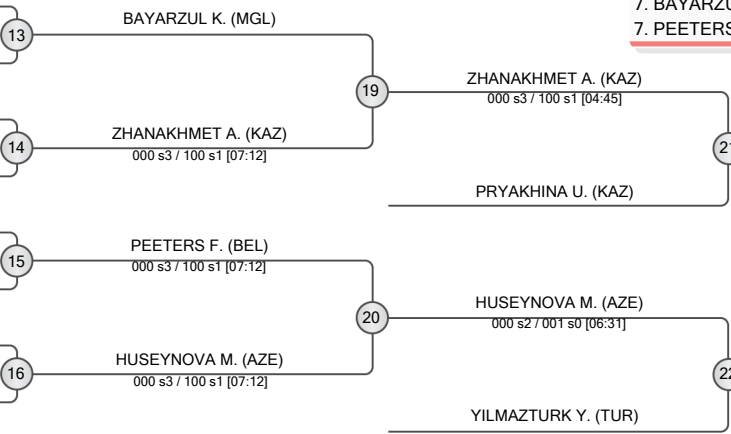

FINAL RESULTS		
1.	YUKSEL Sema Nur	TUR
2.	COSKUN Busra Ceylin	TUR
3.	PRYAKHINA Ulyana	KAZ
3.	YILMAZTURK Yagmur	TUR
5.	ZHANAKHMET Adiya	KAZ
5.	HUSEYNOVA Madina	AZE
7.	BAYARZUL Khulan	MGL
7.	PEETERS Fenne	BEL





Antalya Millennium Team Cadet European Cup 2025

Türkiye, Antalya, 8-9 Mar 2025

-44 kg

Women (25)

POOL A

	GASHI Blerina	KOS
	ABDUKADYROVA Sevinch	KAZ
	OZENC Feride	TUR
	SAKHABADIN Inzhu	KAZ
	MANASBEKOVA Munira	KGZ
	SEYIDZADE Zeynab	AZE
	SAHINER Tugce	TUR

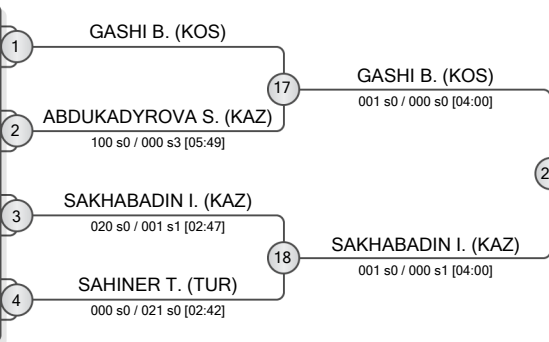

POOL B

	MEKI Fatma Zehra	TUR
	HUSEYNOVA Gulshan	AZE
	RAKHIMZHANOVA Shakhsanam	KAZ
	SAPARASHVILI Nino	GEO
	KULAK Elif Azra	TUR
	VASILEVA Ema	BUL

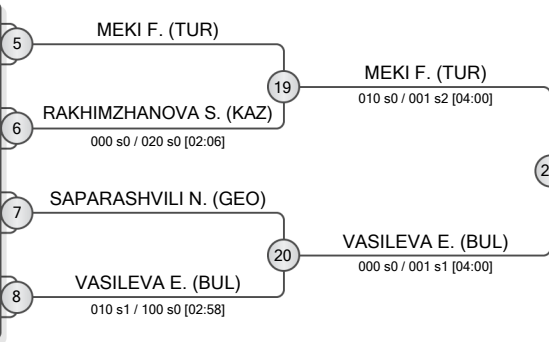

POOL C

	KAYIR Livanur	TUR
	TALGAT Nazym	KAZ
	GRIGORYAN Viktoria	BEL
	ASANBEKOVA Aliia	KGZ
	ABDULLAYEVA Khadija	AZE
	MERAL Hatice	TUR

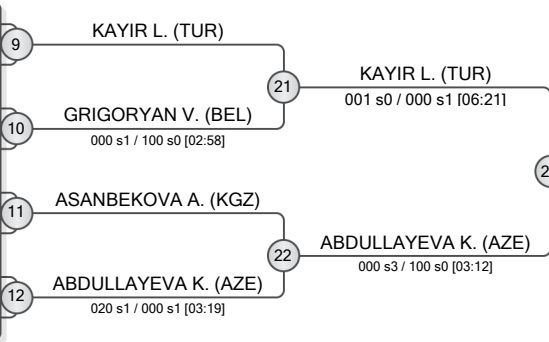

POOL D

	SEITZHANOVA Ainara	KAZ
	ICEL Zehra Nur	TUR
	ABDULLAYEVA Fatima	AZE
	TSOTSKOLAURI Khatia	GEO
	TODOROVA Ivon	BUL
	KANDEMIR Leyla Hazal	TUR

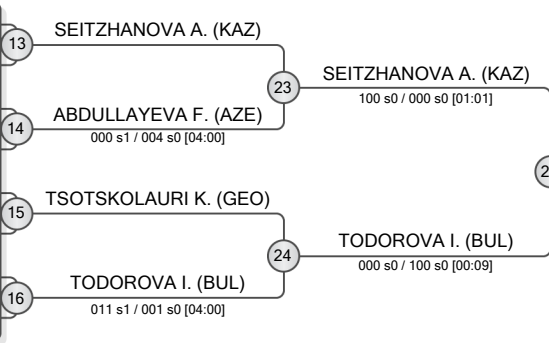

REPECHAGE

29 ABDUKADYROVA S. (KAZ)	30 RAKHIMZHANOVA S. (KAZ)	31 GRIGORYAN V. (BEL)	32 ABDULLAYEVA F. (AZE)
33 SAKHABADIN I. (KAZ)	34 VASILEVA E. (BUL)	35 ABDULLAYEVA K. (AZE)	36 TODOROVA I. (BUL)

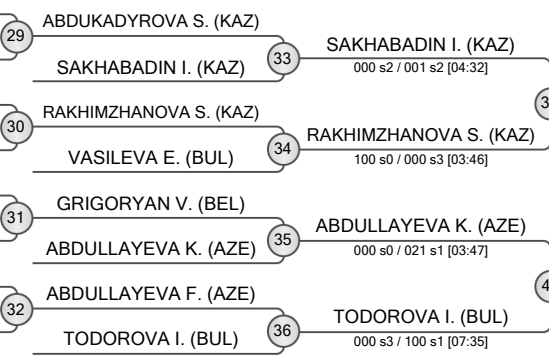

FINAL RESULTS		
1.	MEKI Fatma Zehra	TUR
2.	KAYIR Livanur	TUR
3.	SEITZHANOVA Ainara	KAZ
4.	GASHI Blerina	KOS
5.	SAKHABADIN Inzhu	KAZ
6.	ABDULLAYEVA Khadija	AZE
7.	RAKHIMZHANOVA Shakhsanam	KAZ
8.	TODOROVA Ivon	BUL





Antalya Millennium Team Cadet European Cup 2025

Türkiye, Antalya, 8-9 Mar 2025

-48 kg

Women (34)

POOL A

	KUCUK Beyza	TUR	1	KUCUK B. (TUR)
	TALGARTBEKOVA Iasemin	KGZ	2	TALGARTBEKOVA I. (KGZ)
	NURLANKYZY Aikhanym	KAZ	3	NURLANKYZY A. (KAZ)
	EYVAZLI Konul	AZE	4	EYVAZLI K. (AZE)
	GRIGOROVA Kalina	BUL	5	GRIGOROVA K. (BUL)
	STAVROPOULOU Iliana	GRE	6	STAVROPOULOU I. (GRE)
	BENDELIANI Mariam	GEO	7	AGHAMIRZAZADE N. (AZE)
	AGHAMIRZAZADE Narmin	AZE	7	AGHAMIRZAZADE N. (AZE)
	SIMSEK Bilge	TUR	8	SIMSEK B. (TUR)

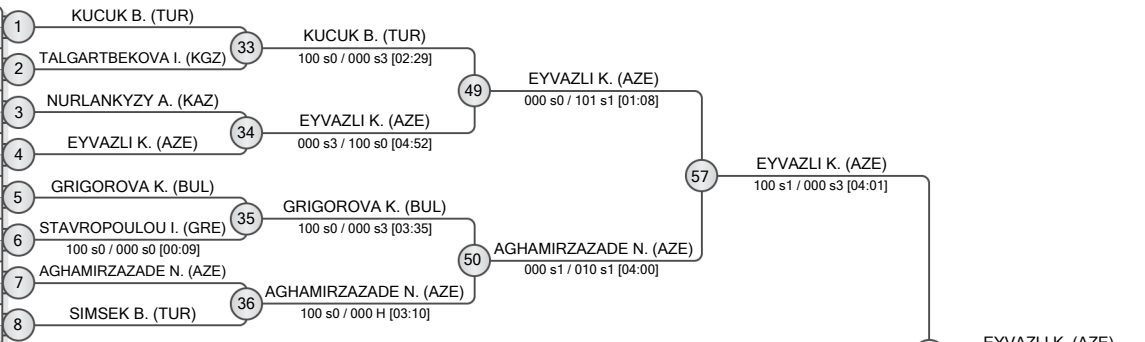

POOL B

	MERKVILADZE Salome	GEO	9	MERKVILADZE S. (GEO)
	GASHI Elita	KOS	10	GASHI E. (KOS)
	UCAR Fatmanur	TUR	11	UCAR F. (TUR)
	PJATECKA Varvara	LAT	12	PJATECKA V. (LAT)
	AHMADOVA Nargiz	AZE	13	AHMADOVA N. (AZE)
	SARKYTBK Zhanel	KAZ	14	SARKYTBK Z. (KAZ)
	BOSKUP Aysenur	TUR	15	BOSKUP A. (TUR)
	GANBAATAR Tsogzolmaa	MGL	16	GANBAATAR T. (MGL)

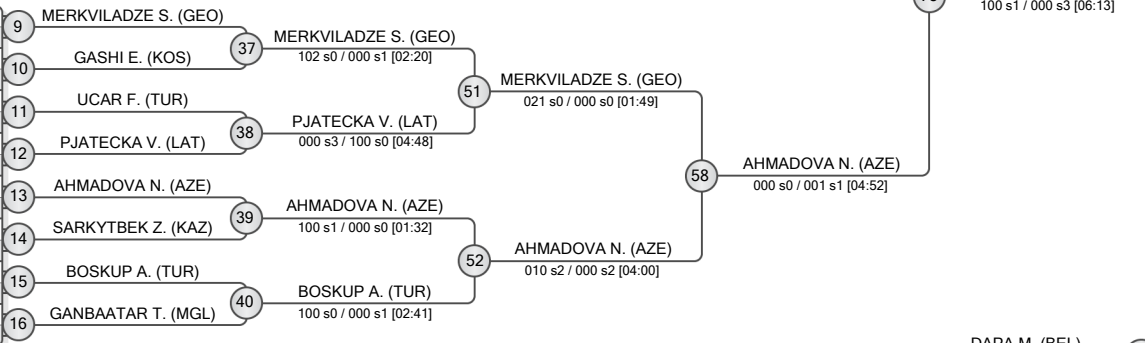

POOL C

	RUSLANOVA Assel	KAZ	17	RUSLANOVA A. (KAZ)
	GASHI Besjana	KOS	18	GASHI B. (KOS)
	AKKAYA Ayla	TUR	19	AKKAYA A. (TUR)
	IASHVILI Natali	GEO	20	MAMISHOVA N. (AZE)
	MAMISHOVA Nigar	AZE	20	MAMISHOVA N. (AZE)
	MUSAYEVA Gulgaz	AZE	21	MUSAYEVA G. (AZE)
	SYNKAROVA Anhelina	IJF	22	SYNKAROVA A. (IJF)
	OSMONOVA Raiana Taalaibekovna	KGZ	23	OSMONOVA R. (KGZ)
	HIZLI Ecrin Su	TUR	24	HIZLI E. (TUR)

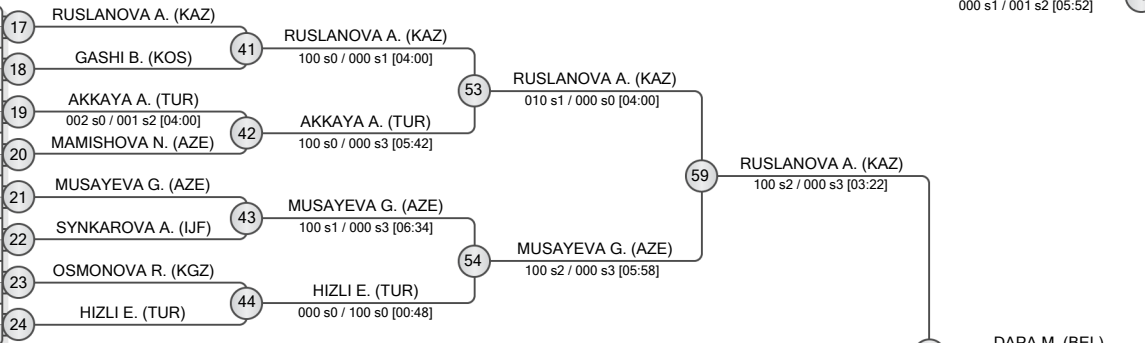

POOL D

	WSHAH Houda	JOR	25	WSHAH H. (JOR)
	ALAKBAROVA Leyla	AZE	26	ALAKBAROVA L. (AZE)
	CELIK Aylin	TUR	27	CELIK A. (TUR)
	BATBAYAR Tumenjargal	MGL	28	BATBAYAR T. (MGL)
	ERCIN Rahime	TUR	29	ERCIN R. (TUR)
	DAPA Maelys	BEL	30	DAPA M. (BEL)
	RINATKYZY Ayazhan	KAZ	31	RINATKYZY A. (KAZ)
	TSURTSUMIA Mariam	GEO	32	TSURTSUMIA M. (GEO)

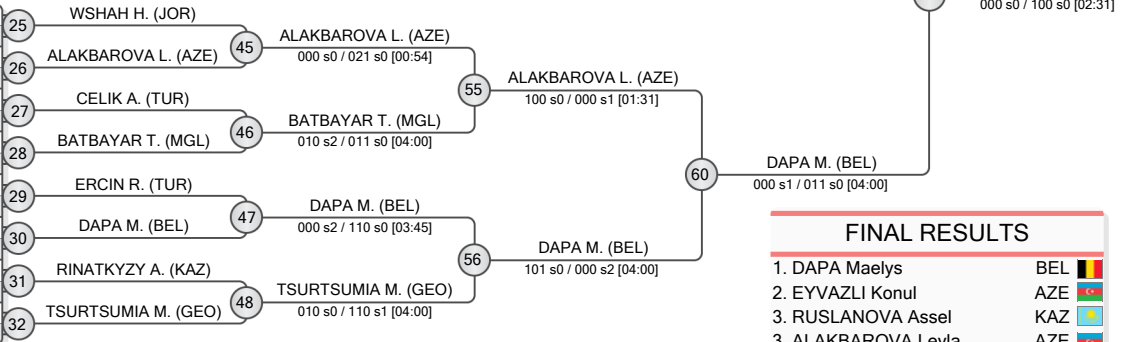

FINAL RESULTS		
1.	DAPA Maelys	BEL
2.	EYVAZLI Konul	AZE
3.	RUSLANOVA Assel	KAZ
3.	ALAKBAROVA Leyla	AZE
5.	AGHAMIRZAZADE Narmin	AZE
5.	AHMADOVA Nargiz	AZE
7.	BOSKUP Aysenur	TUR
7.	MUSAYEVA Gulgaz	AZE

REPECHAGE

NURLANKYZY A. (KAZ)	61	NURLANKYZY A. (KAZ)	65	KUCUK B. (TUR)
SARKYTBK Z. (KAZ)	62	SARKYTBK Z. (KAZ)	66	BOSKUP A. (TUR)
GASHI B. (KOS)	63	GASHI B. (KOS)	67	GASHI B. (KOS)
ERCIN R. (TUR)	64	ERCIN R. (TUR)	68	TSURTSUMIA M. (GEO)

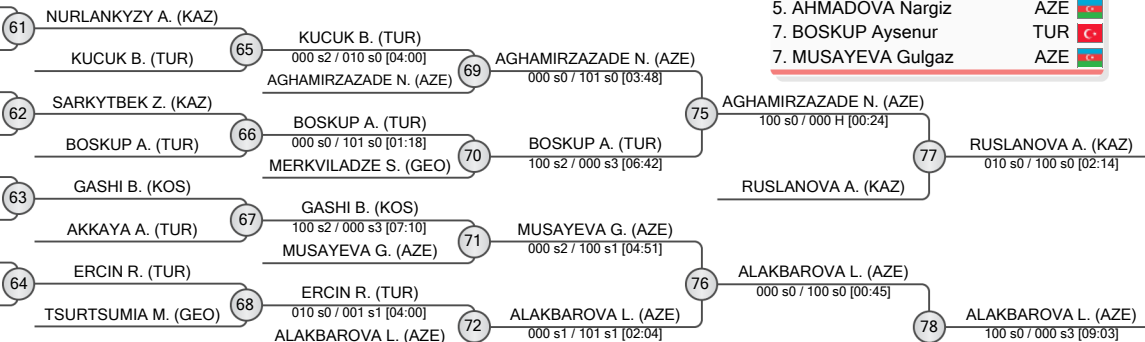



Antalya Millennium Team Cadet European Cup 2025

Türkiye, Antalya, 8-9 Mar 2025

-52 kg

Women (31)

POOL A

	MARATBEK Zhanaiym	KAZ	1	MARATBEK Z. (KAZ)
	OZDIL Aysenur	TUR	2	OZDIL A. (TUR)
	VALSAMI Iris	GRE	3	OZ D. (TUR)
	OZ Dilara	TUR	3	OZ D. (TUR)
	AL SAIFI Sara	JOR	4	MURSALIYEVA M. (AZE)
	TOTRASHVILI Mariam	GEO	4	MURSALIYEVA M. (AZE)
	MURSALIYEVA Maleyka	AZE	4	MURSALIYEVA M. (AZE)

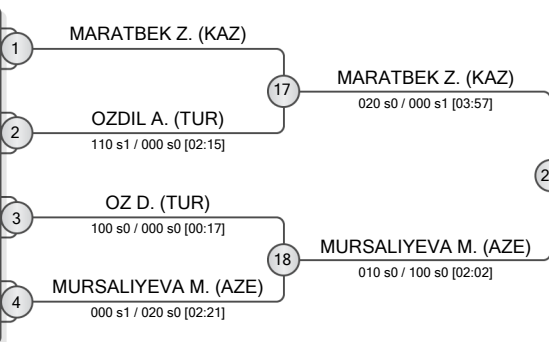

POOL B

	KHARAISHVILI Nino	GEO	5	KHARAISHVILI N. (GEO)
	DODAJ Sidorela	KOS	6	DURALI A. (KAZ)
	EKIN Silan	TUR	6	DURALI A. (KAZ)
	DURALI Ayazhan	KAZ	6	DURALI A. (KAZ)
	LKHAGVADORJ Sayajargal	MGL	7	MAISEYENKA A. (IJF)
	MAISEYENKA Aliaksandra	IJF	7	MAISEYENKA A. (IJF)
	YESILTAS Semanur	TUR	8	YESILTAS S. (TUR)
	MAMATKERIMOVA Aliya	KGZ	8	YESILTAS S. (TUR)

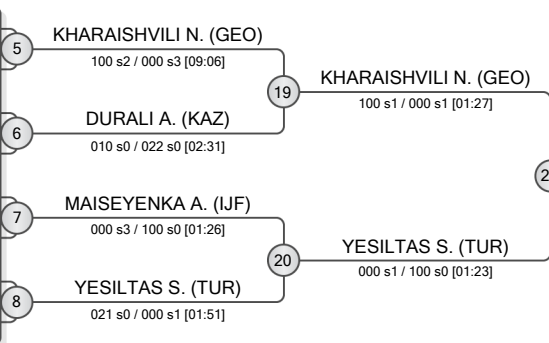

POOL C

	IOSIFIDOU Veroniki	GRE	9	IOSIFIDOU V. (GRE)
	DZHAROVA Samira	KGZ	10	IOSIFIDOU V. (GRE)
	BOLOTASHVILI Tekla	GEO	10	IOSIFIDOU V. (GRE)
	BUKULMEZ Kevser Gizem	TUR	10	IOSIFIDOU V. (GRE)
	QURBONZODA Madina	TJK	11	QURBONZODA M. (TJK)
	ZHUMAZHAN Inzhu	KAZ	11	QURBONZODA M. (TJK)
	VADOVICOVA Vivien	SVK	12	QURBONZODA M. (TJK)
	KOYAK Aleyna Sena	TUR	12	QURBONZODA M. (TJK)

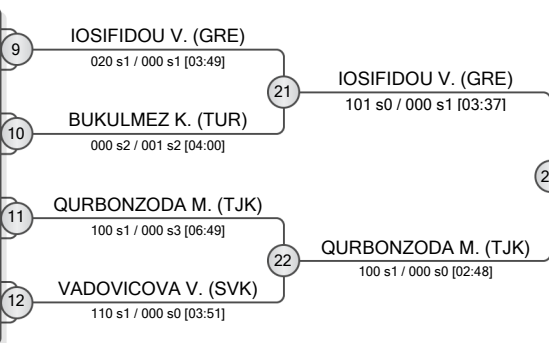

POOL D

	SUPYGALIYEVA Fatima	KAZ	13	SUPYGALIYEVA F. (KAZ)
	ZHARSKAYA Alisiya	IJF	14	DOGAN Z. (TUR)
	MARATOVA Liya	KGZ	14	DOGAN Z. (TUR)
	DOGAN Zeynep	TUR	14	DOGAN Z. (TUR)
	GULIASHVILI Mariam	GEO	15	GULIASHVILI M. (GEO)
	SHIKHMAMMADOVA Nargiz	AZE	15	GULIASHVILI M. (GEO)
	MARKOVA Maraya	BUL	16	GULIASHVILI M. (GEO)
	UNAL Guleser	TUR	16	GULIASHVILI M. (GEO)

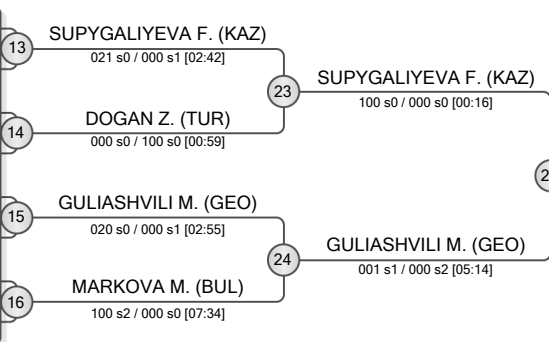

REPECHAGE

	OZDIL A. (TUR)	29	OZDIL A. (TUR)	33	OZDIL A. (TUR)
	DODAJ S. (KOS)		DODAJ S. (KOS)		YESILTAS S. (TUR)
	DURALI A. (KAZ)	30	DODAJ S. (KOS)	34	YESILTAS S. (TUR)
	DZHAROVA S. (KGZ)		YESILTAS S. (TUR)		
	BUKULMEZ K. (TUR)	31	DZHAROVA S. (KGZ)	35	QURBONZODA M. (TJK)
	ZHARSKAYA A. (IJF)		QURBONZODA M. (TJK)		
	DOGAN Z. (TUR)	32	ZHARSKAYA A. (IJF)	36	GULIASHVILI M. (GEO)
			GULIASHVILI M. (GEO)		

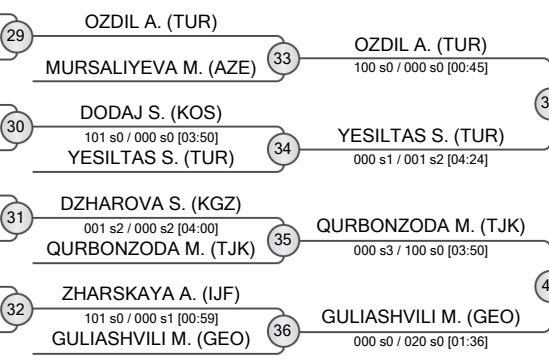

FINAL RESULTS

- SUPYGALIYEVA Fatima KAZ
- MARATBEK Zhanaiym KAZ
- IOSIFIDOU Veroniki GRE
- QURBONZODA Madina TJK
- OZDIL Aysenur TUR
- KHARAISHVILI Nino GEO
- YESILTAS Semanur TUR
- GULIASHVILI Mariam GEO





Antalya Millennium Team Cadet European Cup 2025

Türkiye, Antalya, 8-9 Mar 2025

-57 kg

Women (35)

POOL A

	MASHBAT Tsendbazar	MGL	1	MASHBAT T. (MGL)
	ELDAROVA Diana	AZE	2	ELDAROVA D. (AZE)
	BECHVAIA Elisabed	GEO	3	TOPCU E. (TUR)
	TOPCU Ezgi	TUR	4	SEMBEK Y. (KAZ)
	SEMBEK Yerkenaz	KAZ	4	SEMBEK Y. (KAZ)
	KALYKOVA Aruuke	KGZ	5	KALYKOVA A. (KGZ)
	RUSTAMOVA Aliya	AZE	6	RUSTAMOVA A. (AZE)
	SARIYEVA Assiya	KAZ	7	SARIYEVA A. (KAZ)
	OKRUASHVILI Mariami	GEO	8	OKRUASHVILI M. (GEO)

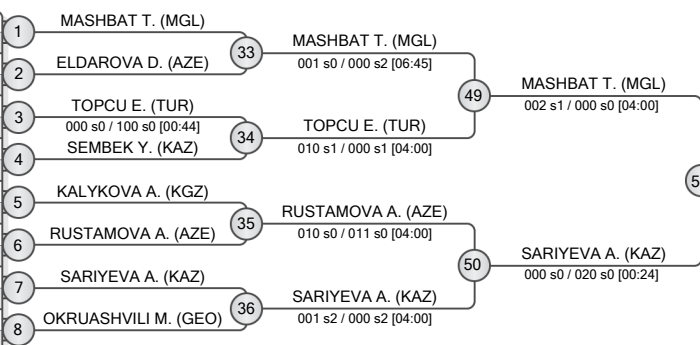

POOL B

	GOGALADZE Diana	GEO	9	GOGALADZE D. (GEO)
	CINAR Merve	TUR	10	CINAR M. (TUR)
	ZIJADE Enise	KOS	11	ZIJADE E. (KOS)
	KALILOVA Begaiym	KGZ	12	KALILOVA B. (KGZ)
	GULBANI Tinatin	GEO	13	GULBANI T. (GEO)
	SULEIMENOVA Aida	KAZ	14	SULEIMENOVA A. (KAZ)
	YUSIFLI Samaya	AZE	15	YUSIFLI S. (AZE)
	KILIC Elif	TUR	16	KILIC E. (TUR)

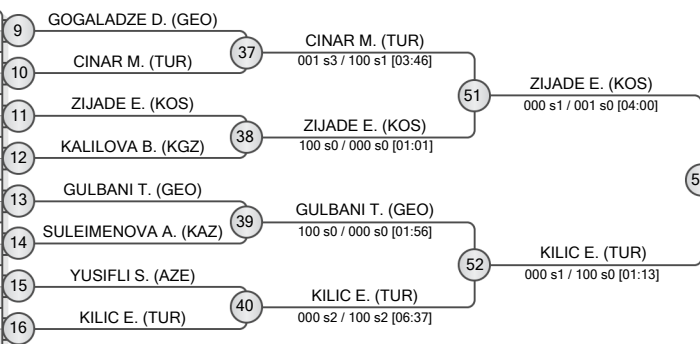

POOL C

	KAKITAEVA Aidai	KGZ	17	KAKITAEVA A. (KGZ)
	TURK Irem Berra	TUR	18	TURK I. (TUR)
	URBEKHASHVILI Sopiko	GEO	19	URBEKHASHVILI S. (GEO)
	MAMMADTAGHIYEVA Gulnaz	AZE	20	MAMMADTAGHIYEVA G. (AZE)
	TATRISHVILI Sopio	GEO	21	TATRISHVILI S. (GEO)
	STOEVA Andrea	BUL	22	STOEVA A. (BUL)
	KHEGAY Kira	KAZ	23	YILMAZ L. (TUR)
	YILMAZ Lara	TUR	23	YILMAZ L. (TUR)
	VALIYEVA Nazakat	AZE	24	VALIYEVA N. (AZE)

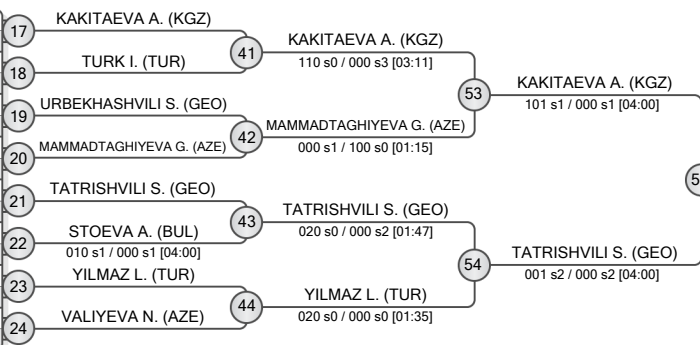

POOL D

	GAMIASHVILI Tamar	GEO	25	GAMIASHVILI T. (GEO)
	BESTAV Selin	TUR	26	BESTAV S. (TUR)
	KYIALBEKOVA Aaisha	KGZ	27	KYIALBEKOVA A. (KGZ)
	MINKO Sofiya	IJF	28	MINKO S. (IJF)
	NAKHUTSRISHVILI Lika	GEO	29	NAKHUTSRISHVILI L. (GEO)
	DASTANKYZY Balnur	KAZ	30	MAMMADOVA A. (AZE)
	MAMMADOVA Aysun	AZE	30	MAMMADOVA A. (AZE)
	BASARIR Ceylin	TUR	31	BASARIR C. (TUR)
	SIMONIA Lizi	GEO	32	SIMONIA L. (GEO)

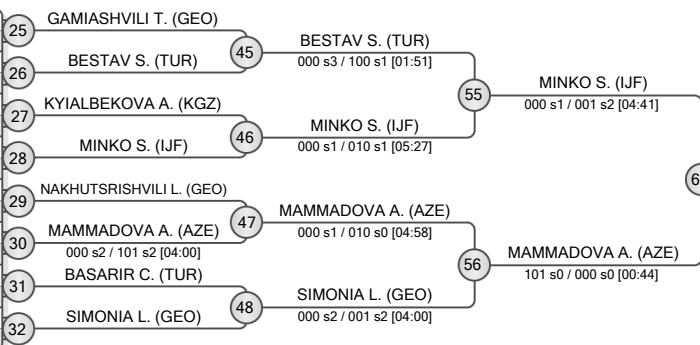

REPECHAGE

61	ELDAROVA D. (AZE)	65	TOPCU E. (TUR)
62	YUSIFLI S. (AZE)	66	GULBANI T. (GEO)
63	STOEVA A. (BUL)	67	YILMAZ L. (TUR)
64	KYIALBEKOVA A. (KGZ)	68	BESTAV S. (TUR)

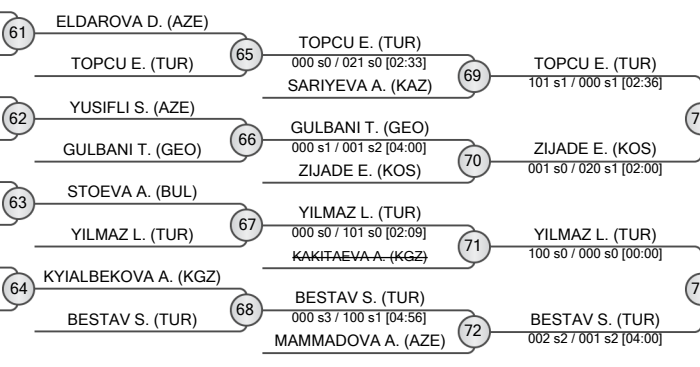

FINAL RESULTS	
1.	KILIC Elif
2.	TATRISHVILI Sopio
3.	ZIJADE Enise
3.	MASHBAT Tsendbazar
5.	MINKO Sofiya
5.	BESTAV Selin
7.	TOPCU Ezgi
7.	YILMAZ Lara





Antalya Millennium Team Cadet European Cup 2025

Türkiye, Antalya, 8-9 Mar 2025

-63 kg

Women (27)

POOL A

	PAPASTERGIOU Anna	GRE
	TSENOVA Aleksandra	BUL
	KILICKAYA Rumeysa Hatice	TUR
	BEETERENS Hanne	BEL
	LISOUSKAYA Sofya	IJF
	MARKHVAIDZE Lizi	GEO
	BILEN Sevim Margaret	TUR

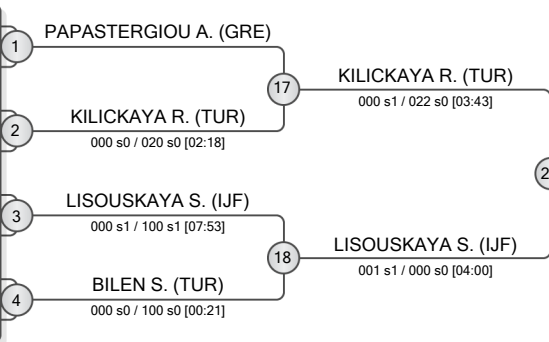

POOL B

	ISSAYEVA Ayaulym	KAZ
	AYDIN Isil Sinem	TUR
	KRAUCHANKA Veronika	IJF
	CHRISAKI Anni-Iris	GRE
	MAZANASHVILI Dali	GEO
	ALIYEVA Ayan	AZE

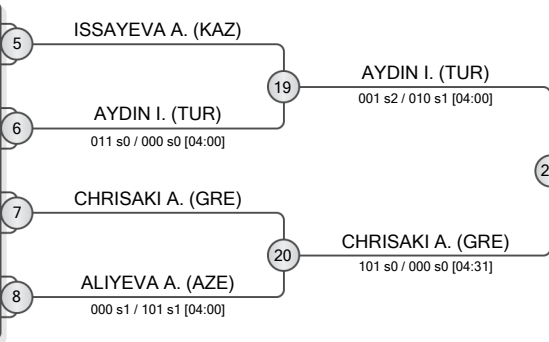

POOL C

	TAXIDOU Eleni	GRE
	KRASKO Varvara	IJF
	BAGHIRLI Aydan	AZE
	TEMIRKANOVA Asema	KGZ
	PKHAKADZE Barbara	GEO
	CIFTYILDIZ Ennur	TUR
	SERIK Azima	KAZ

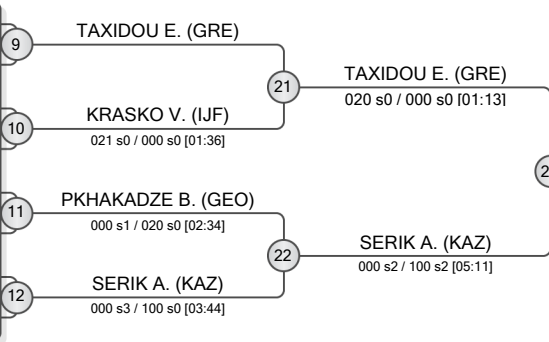

POOL D

	GULBIANI Nana	GEO
	TURLYBEK Nursezim	KAZ
	AKPINAR Nisa	TUR
	MAIDANA Juana	ARG
	TODOROVA Elitsa	BUL
	CIL Latife Zumra	TUR
	HRAMYKA Elina	IJF

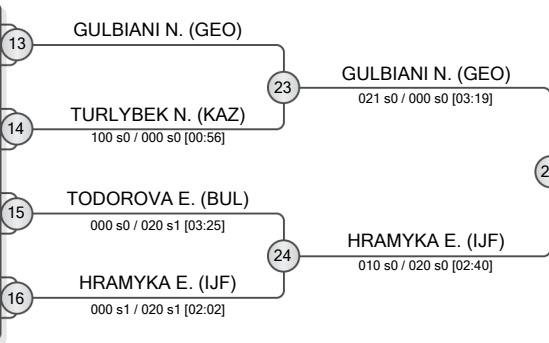

FINAL RESULTS		
1.	GULBIANI Nana	GEO
2.	KILICKAYA Rumeysa Hatice	TUR
3.	LISOUSKAYA Sofya	IJF
3.	AYDIN Isil Sinem	TUR
5.	TAXIDOU Eleni	GRE
5.	SERIK Azima	KAZ
7.	ISSAYEVA Ayaulym	KAZ
7.	TURLYBEK Nursezim	KAZ

REPECHAGE

TSENOVA A. (BUL)	29	TSENOVA A. (BUL)	33	LISOUSKAYA S. (IJF)
PAPASTERGIOU A. (GRE)		LISOUSKAYA S. (IJF)		
KRAUCHANKA V. (IJF)		ISSAYEVA A. (KAZ)		
ISSAYEVA A. (KAZ)	30	CHRISAKI A. (GRE)	34	ISSAYEVA A. (KAZ)
KRASKO V. (IJF)		SERIK A. (KAZ)		
KRASKO V. (IJF)	31	TURLYBEK N. (KAZ)		
TURLYBEK N. (KAZ)		HRAMYKA E. (IJF)		
TURLYBEK N. (KAZ)	32	HRAMYKA E. (IJF)	36	TURLYBEK N. (KAZ)

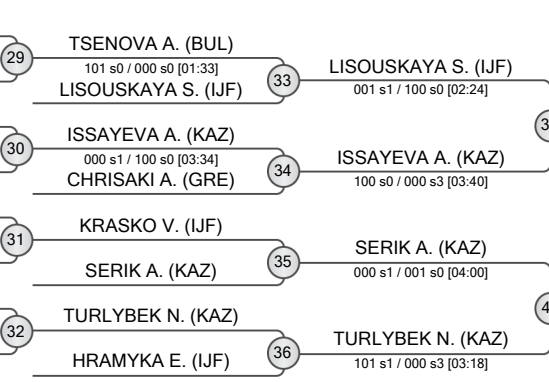



Antalya Millennium Team Cadet European Cup 2025

Türkiye, Antalya, 8-9 Mar 2025

-70 kg

Women (25)

POOL A

	ROBAKIDZE Ketı	GEO	1
	BAYRAMLI Malak	AZE	2
	BALCI Hatice Nur	TUR	3
	DZAGANIA Nini	GEO	4
	OZBUDAK Done Melike	TUR	5
	KOKRMAZ Behiye	TUR	6
	TURLYBEK Gulsezim	KAZ	7

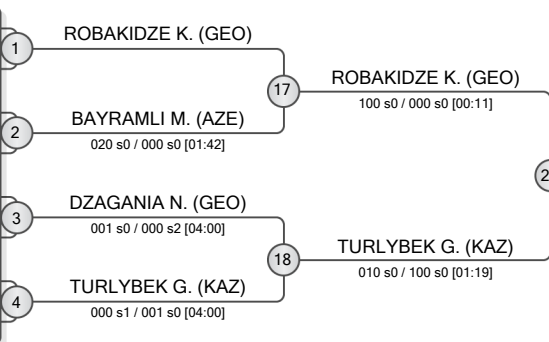

POOL B

	HUDIKA Vita	CRO	5
	PLESKATSEVICH Darya	IJF	6
	KOKSAL Cennet Emine	TUR	7
	TOMBOU Valerie	BEL	8
	TEPE Ayse Minel	TUR	9
	ALTAY Aisha	KAZ	10

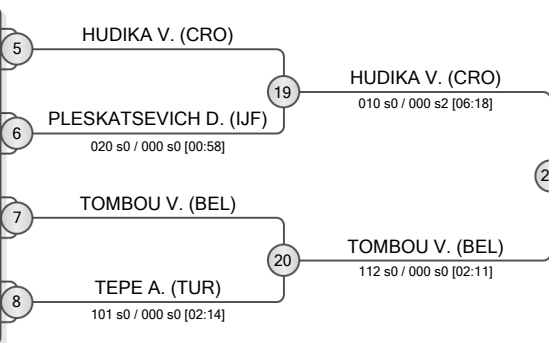

POOL C

	KONOKBAEVA Azima	KGZ	9
	MAMMADLI Masuma	AZE	10
	AYDOGAN Ceren	TUR	11
	KHOJANAZAROVA Uldana	KAZ	12
	TURGUT Hira Nur	TUR	13
	GHALADZE Maia	GEO	14

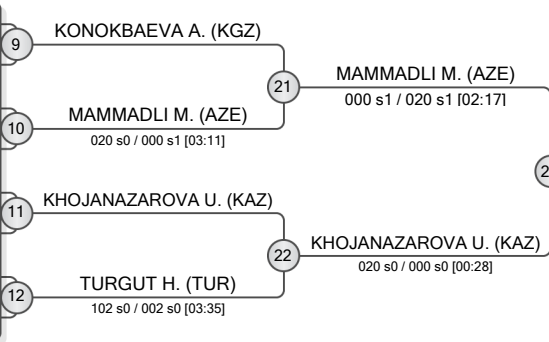

POOL D

	BESKER Ana	CRO	13
	YARMANTOVICH Sofya	IJF	14
	KARATAS Busra	TUR	15
	KURDGELIA Elene	GEO	16
	TOKER Melis	TUR	17
	JALILLI Fidan	AZE	18

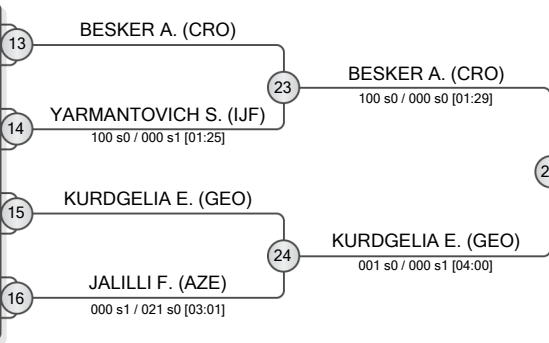

FINAL RESULTS		
1.	TOMBOU Valerie	BEL
2.	KURDGELIA Elene	GEO
3.	ROBAKIDZE Ketı	GEO
3.	BESKER Ana	CRO
5.	KHOJANAZAROVA Uldana	KAZ
5.	TURLYBEK Gulsezim	KAZ
7.	HUDIKA Vita	CRO
7.	TURGUT Hira Nur	TUR

REPECHAGE

KOKRMAZ B. (TUR)	29	KOKRMAZ B. (TUR)	30	KOKRMAZ B. (TUR)	31
DZAGANIA N. (GEO)	32	ROBAKIDZE K. (GEO)	33	ROBAKIDZE K. (GEO)	34
TEPE A. (TUR)	35	HUDIKA V. (CRO)	36	HUDIKA V. (CRO)	37
TURGUT H. (TUR)	38	TURGUT H. (TUR)	39	TURGUT H. (TUR)	40
JALILLI F. (AZE)	41	JALILLI F. (AZE)	42	BESKER A. (CRO)	43
JALILLI F. (AZE)	44	BESKER A. (CRO)	45	BESKER A. (CRO)	46

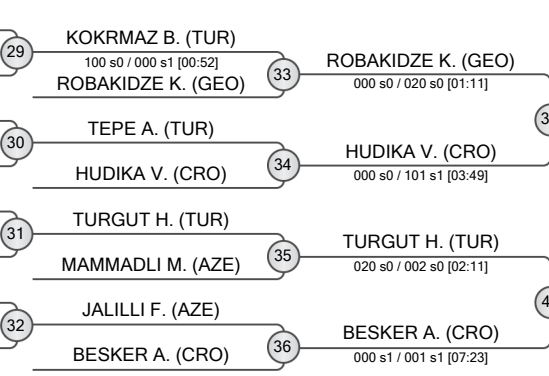



Antalya Millennium Team Cadet European Cup 2025

Türkiye, Antalya, 8-9 Mar 2025

+ 70 kg

Women (19)

POOL A

	TURDAZHIEVA Akmarzhan	KGZ	1	TURDAZHIEVA A. (KGZ)
	OZCAN Fatma Nur	TUR	2	OZCAN F. (TUR)
	DIKER Guner Kiymet	TUR	3	DIKER G. (TUR)
	KIZIKURASHVILI Nutsa	GEO	4	KIZIKURASHVILI N. (GEO)

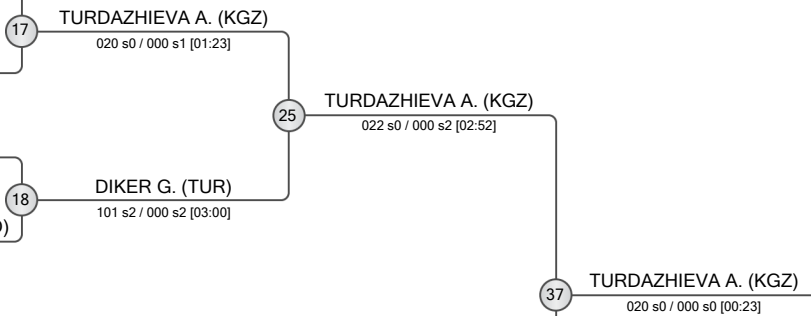

POOL B

	BEKIMOVA Renata	KAZ	5	BEKIMOVA R. (KAZ)
	KAPIANIDZE Nia	GEO	6	KAPIANIDZE N. (GEO)
	CHERKELIEVA Maria	BUL	7	CHERKELIEVA M. (BUL)
	KESKIN Aysenur	TUR	8	ALIYEVA Z. (AZE)
	ALIYEVA Zemfira	AZE	8	000 s2 / 002 s2 [04:00]

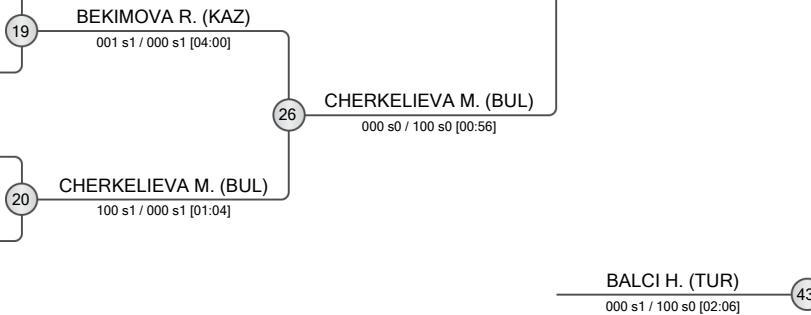

POOL C

	GELASHVILI Barbare	GEO	9	GELASHVILI B. (GEO)
	SERIN Nisanur	TUR	10	SERIN N. (TUR)
	YILDIRIM Sema	TUR	11	YILDIRIM S. (TUR)
	ARSTANBEKOVA Ramilya	KAZ	12	ARSTANBEKOVA R. (KAZ)
	HABIBLI Daniz	AZE	12	100 s1 / 000 s3 [02:57]

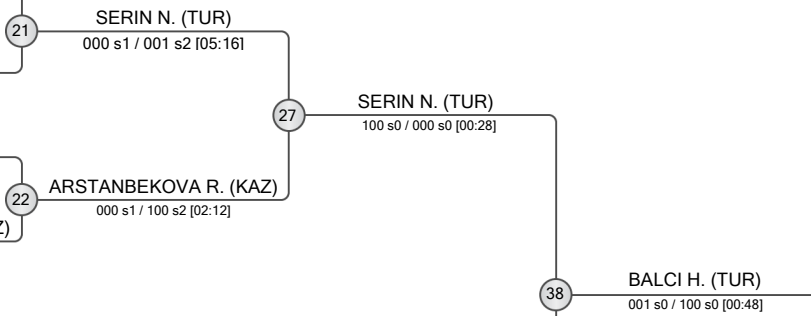

POOL D

	KVARATSKHELIA Nona	GEO	13	KVARATSKHELIA N. (GEO)
	YARASHEVICH Palina	IJF	14	BALCI H. (TUR)
	BALCI Hatice Tuana	TUR	14	000 s3 / 100 s1 [01:24]
	TOLEBAY Togzhan	KAZ	15	TOLEBAY T. (KAZ)
	OZKAN Muruvvet Nur	TUR	16	OZKAN M. (TUR)

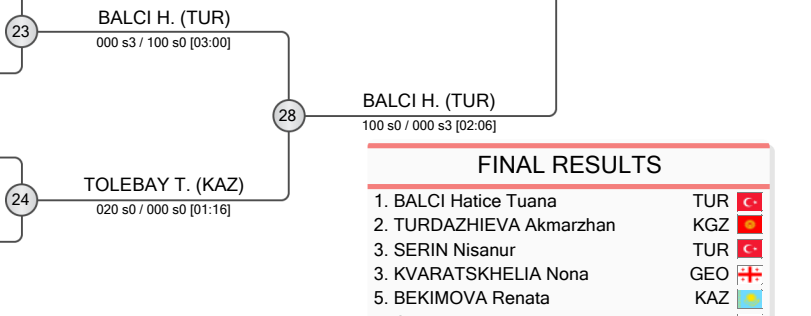

FINAL RESULTS

1.	BALCI Hatice Tuana	TUR	
2.	TURDAZHIEVA Akmarzhan	KGZ	
3.	SERIN Nisanur	TUR	
3.	KVARATSKHELIA Nona	GEO	
5.	BEKIMOVA Renata	KAZ	
7.	CHERKELIEVA Maria	BUL	
7.	DIKER Guner Kiymet	TUR	
7.	GELASHVILI Barbare	GEO	

REPECHAGE

OZCAN F. (TUR)	29	OZCAN F. (TUR)	DIKER G. (TUR)	33	000 s0 / 100 s0 [01:02]
ALIYEVA Z. (AZE)	30	ALIYEVA Z. (AZE)	BEKIMOVA R. (KAZ)	34	000 s0 / 020 s1 [01:29]
GELASHVILI B. (GEO)	31	GELASHVILI B. (GEO)	GELASHVILI B. (GEO)	35	010 s2 / 000 s1 [04:00]
YARASHEVICH P. (IJF)	32	KVARATSKHELIA N. (GEO)	KVARATSKHELIA N. (GEO)	36	000 s0 / 100 s0 [00:45]
KVARATSKHELIA N. (GEO)	32	TOLEBAY T. (KAZ)	KVARATSKHELIA N. (GEO)	36	101 s1 / 000 s2 [02:14]

