



Berlin Millennium Team Cadet European Cup 2026

Germany, Berlin, 25-26 Apr 2026

-50 kg

Men (50)

POOL A

1	GAT MUALEM Hillel	ISR	1	GAT MUALEM H. (ISR)
2	FOTA Mina Robin	ROU	33	CABEZAS SEVILLA V. (ESP)
3	CABEZAS SEVILLA Victor	ESP	34	ZUBETS R. (EST)
4	GAFFARLI Ali	GER	35	ROLNICKI A. (ISR)
5	GEUNS Gust	BEL	36	LAHRIFI M. (FRA)
6	ZUBETS Rodion	EST	37	DOGRU S. (TUR)
7	SEGUIN Louie	GBR	38	LOPEZ PEREIRA H. (ESP)
8	ROLNICKI Alon	ISR	39	ABDUVAKHOBOV M. (UZB)
9	MATANOVIC Luka	SRB	40	MAMATOV A. (KGZ)
10	POELSTRA Ferron	NED	41	DOBROVOLSKIS M. (LTU)
11	MUNTEANU Ruslan	MDA	42	MOUSSAID M. (BEL)
12	SPURK Paul	GER	43	RAHMANI N. (ISR)
13	LAHRIFI Moulay-Mountasir	FRA	44	MAMETIYEV R. (GER)

POOL B

9	DOGRU Suleyman	TUR	37	DOGRU S. (TUR)
10	ILCHEV Martin	BUL	38	LOPEZ PEREIRA H. (ESP)
11	PATZ John-Lukas	GER	39	ABDUVAKHOBOV M. (UZB)
12	JASAITIS Rokas	LTU	40	MAMATOV A. (KGZ)
13	LOPEZ PEREIRA Hugo	ESP	41	DOBROVOLSKIS M. (LTU)
14	KOSLAEV Muhammad	AUT	42	MOUSSAID M. (BEL)
15	ABDUVAKHOBOV Mamurjon	UZB	43	RAHMANI N. (ISR)
16	PALMAERTS Jolan	BEL	44	MAMETIYEV R. (GER)
17	KRETZSCHMAR Dwayne	GER	45	ASIK T. (TUR)
18	MAST Tom	ISR	46	BLASCO PEREZ I. (ESP)
19	ALVES Andre Henrique	POR	47	STOLAKIS M. (GER)
20	MAMATOV Ariet	KGZ	48	SCHMIDT C. (GER)

POOL C

17	HEIMANS Klaas	NED	41	DOBROVOLSKIS M. (LTU)
18	TANASI Sando	LAT	42	MOUSSAID M. (BEL)
19	DOBROVOLSKIS Mantas	LTU	43	RAHMANI N. (ISR)
20	NAKASH Itai	ISR	44	MAMETIYEV R. (GER)
21	MOUSSAID Mehdi	BEL	45	ASIK T. (TUR)
22	DAVYDOV Henry	GER	46	BLASCO PEREZ I. (ESP)
23	YAGUE LANCHA Ruben	ESP	47	STOLAKIS M. (GER)
24	SOUKUP Matyas	CZE	48	SCHMIDT C. (GER)
25	RAHMANI Noam	ISR	49	GAFFARLI A. (GER)
26	BERNUZ Hugo	FRA	50	LAHRIFI M. (FRA)
27	MURTAZALIEV Samad	AUT	51	DOGRU S. (TUR)
28	ISHENALIEV Syimyk	KGZ	52	ABDUVAKHOBOV M. (UZB)
29	MAMETIYEV Roman	GER	53	DOBROVOLSKIS M. (LTU)

POOL D

25	KELLER Aaron Joshua	GER	45	ASIK T. (TUR)
26	MINZAT Marius	MDA	46	BLASCO PEREZ I. (ESP)
27	ASIK Taha Baran	TUR	47	STOLAKIS M. (GER)
28	LEVINGER Ehud	ISR	48	SCHMIDT C. (GER)
29	DEWULF Lorn	BEL	49	GAFFARLI A. (GER)
30	BLASCO PEREZ Imanol	ESP	50	LAHRIFI M. (FRA)
31	STOLAKIS Mariano	GER	51	DOGRU S. (TUR)
32	QUINTINO Armando	POR	52	ABDUVAKHOBOV M. (UZB)
33	TUDOR Alin	ROU	53	DOBROVOLSKIS M. (LTU)
34	MAISURADZE Mate	GEO	54	MAMETIYEV R. (GER)
35	AGHAYEV Nihad	AZE	55	KELLER A. (GER)
36	SCHMIDT Constantin Matthias	GER	56	AGHAYEV N. (AZE)

REPECHAGE

61	SPURK P. (GER)	61	MUNTEANU R. (MDA)	65	ROLNICKI A. (ISR)	69	ROLNICKI A. (ISR)
62	MUNTEANU R. (MDA)	62	ROLNICKI A. (ISR)	66	PALMAERTS J. (BEL)	70	DOGRU S. (TUR)
63	PALMAERTS J. (BEL)	63	ALVES A. (POR)	67	HEIMANS K. (NED)	71	HEIMANS K. (NED)
64	TANASI S. (LAT)	64	HEIMANS K. (NED)	68	MOUSSAID M. (BEL)	72	KELLER A. (GER)
65	HEIMANS K. (NED)	65	MOUSSAID M. (BEL)	69	MAISURADZE M. (GEO)	73	ABDUVAKHOBOV M. (UZB)
66	MAISURADZE M. (GEO)	66	STOLAKIS M. (GER)	70	STOLAKIS M. (GER)	74	AGHAYEV N. (AZE)
67	SCHMIDT C. (GER)	67	KELLER A. (GER)	71	KELLER A. (GER)	75	DOGRU S. (TUR)
68	MUNTEANU R. (MDA)	68	ROLNICKI A. (ISR)	72	GAFFARLI A. (GER)	76	HEIMANS K. (NED)
69	PALMAERTS J. (BEL)	69	PALMAERTS J. (BEL)	73	DOGRU S. (TUR)	77	DOGRU S. (TUR)
70	TANASI S. (LAT)	70	ALVES A. (POR)	74	DOGRU S. (TUR)	78	LAHRIFI M. (FRA)
71	HEIMANS K. (NED)	71	HEIMANS K. (NED)	75	HEIMANS K. (NED)	79	AGHAYEV N. (AZE)
72	MAISURADZE M. (GEO)	72	MOUSSAID M. (BEL)	76	MAMETIYEV R. (GER)		
73	SCHMIDT C. (GER)	73	MAISURADZE M. (GEO)	77	STOLAKIS M. (GER)		
74	MUNTEANU R. (MDA)	74	STOLAKIS M. (GER)	78	KELLER A. (GER)		
75	PALMAERTS J. (BEL)	75	KELLER A. (GER)	79	GAFFARLI A. (GER)		
76	TANASI S. (LAT)	76	ROLNICKI A. (ISR)				
77	HEIMANS K. (NED)	77	DOGRU S. (TUR)				
78	MAISURADZE M. (GEO)	78	HEIMANS K. (NED)				
79	SCHMIDT C. (GER)	79	MAMETIYEV R. (GER)				

FINAL RESULTS

- AGHAYEV Nihad AZE
- ABDUVAKHOBOV Mamurjon UZB
- DOGRU Suleyman TUR
- LAHRIFI Moulay-Mountasir FRA
- DOBROVOLSKIS Mantas LTU
- HEIMANS Klaas NED
- ROLNICKI Alon ISR
- KELLER Aaron Joshua GER





Berlin Millennium Team Cadet European Cup 2026

Germany, Berlin, 25-26 Apr 2026

-55 kg

Men (63)

POOL A

1	UYAR Celil	NED
2	LEUPOLD Ansgar Thorben	GER
3	BEN LULU Jonathan	ISR
4	KREMER Arthur	GER
5	DOCHERTY Jack	GBR
6	BIOSCA GARCIA Renat	ESP
7	DE LAURENTIS Mattia	ITA
8	PICKEL Daniel	ISR
9	SEFSAF Hamza	BEL
10	KOKKONEN Valtteri	FIN
11	DREWS Fabian	GER
12	RACKAUSKAS Ignas	LTU
13	NOETZEL Linus	GER
14	SINAGINS Nils	LAT
15	VUSHEV Aleksandar	BUL

1	UYAR C. (NED)
2	BEN LULU J. (ISR)
3	KREMER A. (GER)
4	DE LAURENTIS M. (ITA)
5	PICKEL D. (ISR)
6	KOKKONEN V. (FIN)
7	NOETZEL L. (GER)
8	VUSHEV A. (BUL)

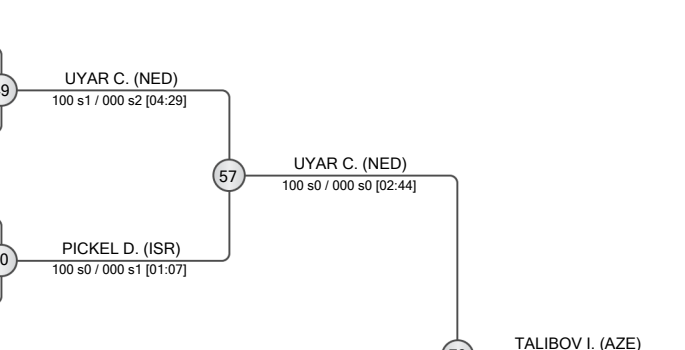

POOL B

9	KHALILLI Rza	AZE
10	ISMAILOV Baiel	KGZ
11	TANSINGCO Gabryl	GER
12	AMARAL Joao	POR
13	BROWN Ishmael	GBR
14	FUCHS Yuval	ISR
15	GARVE Sou	GER
16	LEGER VILLA Lucien	FRA
17	TALIBOV Ibrahim	AZE
18	PANDAY Diego	NED
19	KURBANOV Djamil	AUT
20	PETROSINO Errico	ITA
21	GAFFARLI Al-Hasan	GER
22	OLARASU Constantin	MDA
23	ROMI Guy	ISR
24	LEMONS RODRIGUEZ Omar	ESP

9	ISMAILOV B. (KGZ)
10	TANSINGCO G. (GER)
11	FUCHS Y. (ISR)
12	GARVE S. (GER)
13	TALIBOV I. (AZE)
14	PETROSINO E. (ITA)
15	GAFFARLI A. (GER)
16	ROMI G. (ISR)

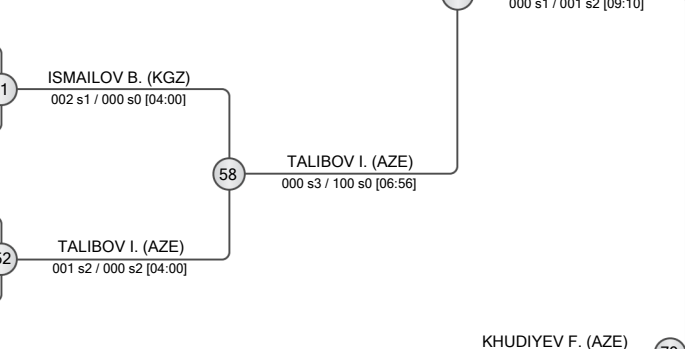

POOL C

17	SHREBERK Guy	ISR
18	EVERS Fynn	GER
19	KHUDIYEV Farid	AZE
20	ZIRAKASHVILI Merabi	GEO
21	BLACKSHAW Reece	GBR
22	BARAK Davor	GER
23	HILARIO Rodrigo	POR
24	KAMCHYBEKOV Yiman	KGZ
25	SHVARTS Amit	ISR
26	VLAD Sorin	ROU
27	VUSHEV Mihail	BUL
28	LASICA Andrej	CRO
29	TABACHNIK Liam	ISR
30	DOUINE Matteo	ITA
31	MANSUR Xavio	NED
32	PETROV Stephan	GER

17	SHREBERK G. (ISR)
18	KHUDIYEV F. (AZE)
19	BLACKSHAW R. (GBR)
20	KAMCHYBEKOV Y. (KGZ)
21	SHVARTS A. (ISR)
22	LASICA A. (CRO)
23	DOUINE M. (ITA)
24	MANSUR X. (NED)

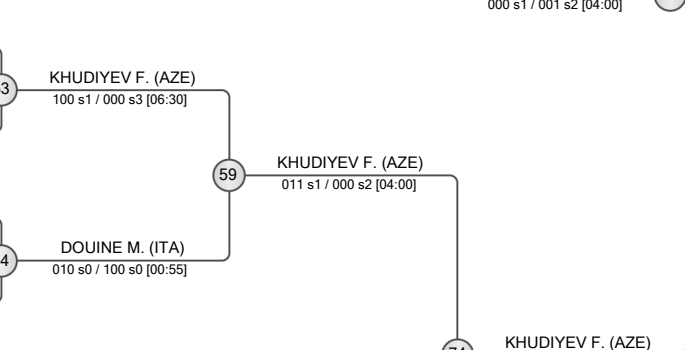

POOL D

25	YUSUPOV Bobur	UZB
26	SILEN Topi	FIN
27	BERMAN Shayan	ISR
28	IEVINS Martins	LAT
29	JAKL Marek	CZE
30	MUELLER Andrej	GER
31	HUNTER Luke	GBR
32	FELLOUKA Loizos	CYP
33	USMONOV Shokhjakhon	UZB
34	ASILBEKOV Ramis Stalbekovich	KGZ
35	HARDT Constantin	GER
36	JOERGENSEN Romeo	DEN
37	RHODES Lewis	GBR
38	TARASOV Aleksander	ISR
39	LLENA CARDIL Ivan	ESP
40	BAUER Eddie	GER

25	YUSUPOV B. (UZB)
26	IEVINS M. (LAT)
27	JAKL M. (CZE)
28	FELLOUKA L. (CYP)
29	ASILBEKOV R. (KGZ)
30	HARDT C. (GER)
31	TARASOV A. (ISR)
32	BAUER E. (GER)

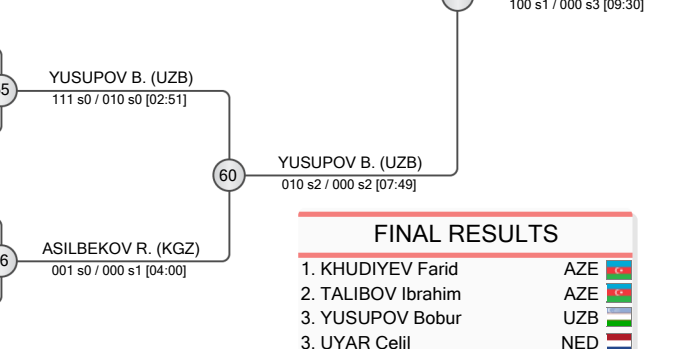

FINAL RESULTS

1. KHUDIYEV Farid (AZE)
2. TALIBOV Ibrahim (AZE)
3. YUSUPOV Bobur (UZB)
3. UYAR Celil (NED)
5. PETROSINO Errico (ITA)
5. SHREBERK Guy (ISR)
7. PICKEL Daniel (ISR)
7. ASILBEKOV Ramis Stalbekovich (KGZ)

REPECHAGE

61	BEN LULU J. (ISR)
62	PANDAY D. (NED)
63	PETROSINO E. (ITA)
64	ZIRAKASHVILI M. (GEO)
65	SHREBERK G. (ISR)
66	SILEN T. (FIN)
67	IEVINS M. (LAT)

61	BEN LULU J. (ISR)
62	PETROSINO E. (ITA)
63	SHREBERK G. (ISR)
64	SILEN T. (FIN)
65	DE LAURENTIS M. (ITA)
66	PETROSINO E. (ITA)
67	SHREBERK G. (ISR)
68	JAKL M. (CZE)

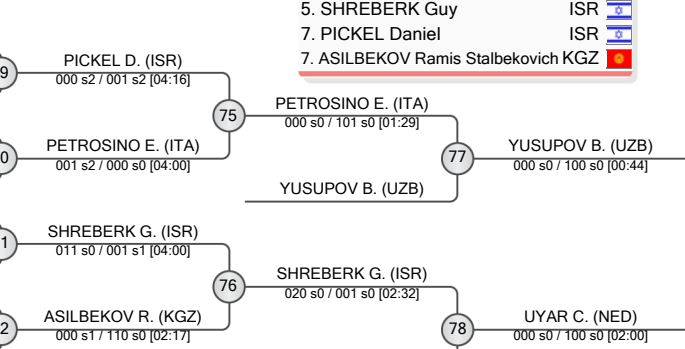



Berlin Millennium Team Cadet European Cup 2026

Germany, Berlin, 25-26 Apr 2026

-60 kg

Men (89)

POOL C

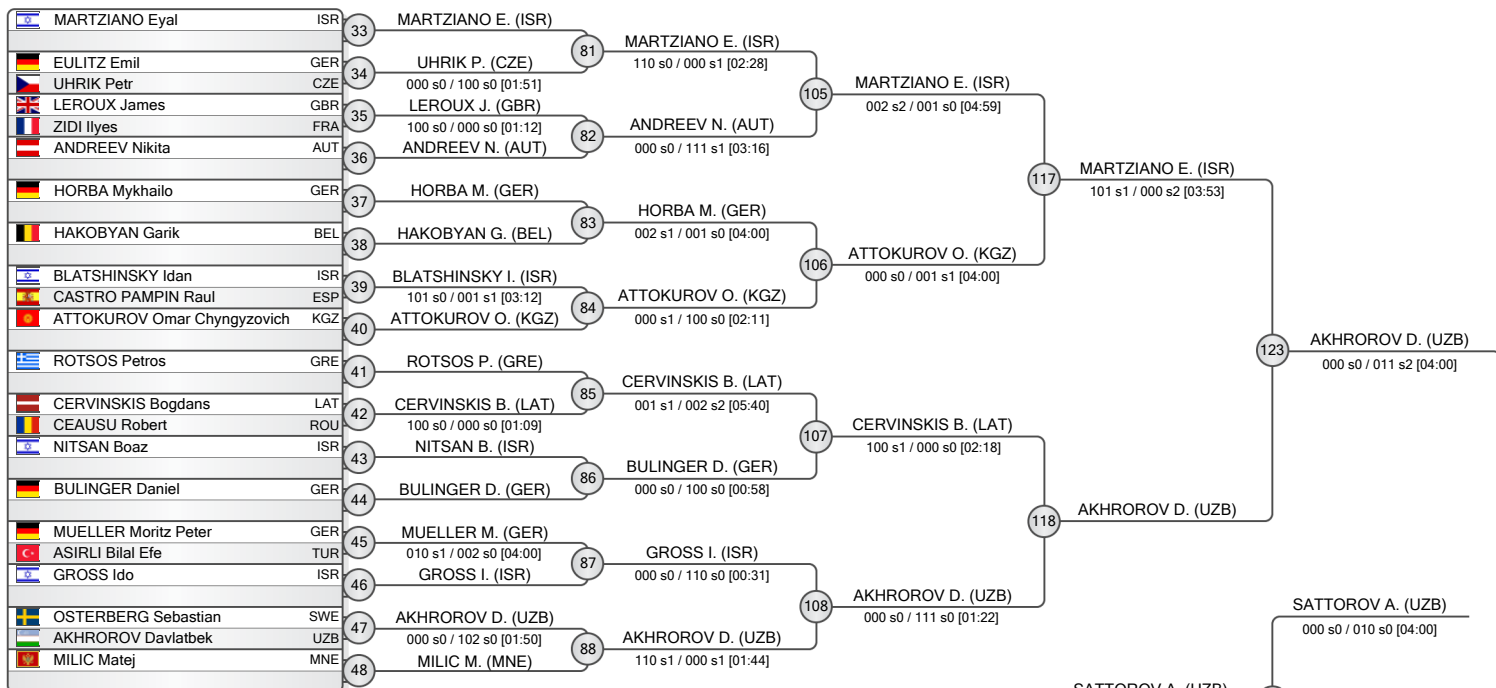

POOL D

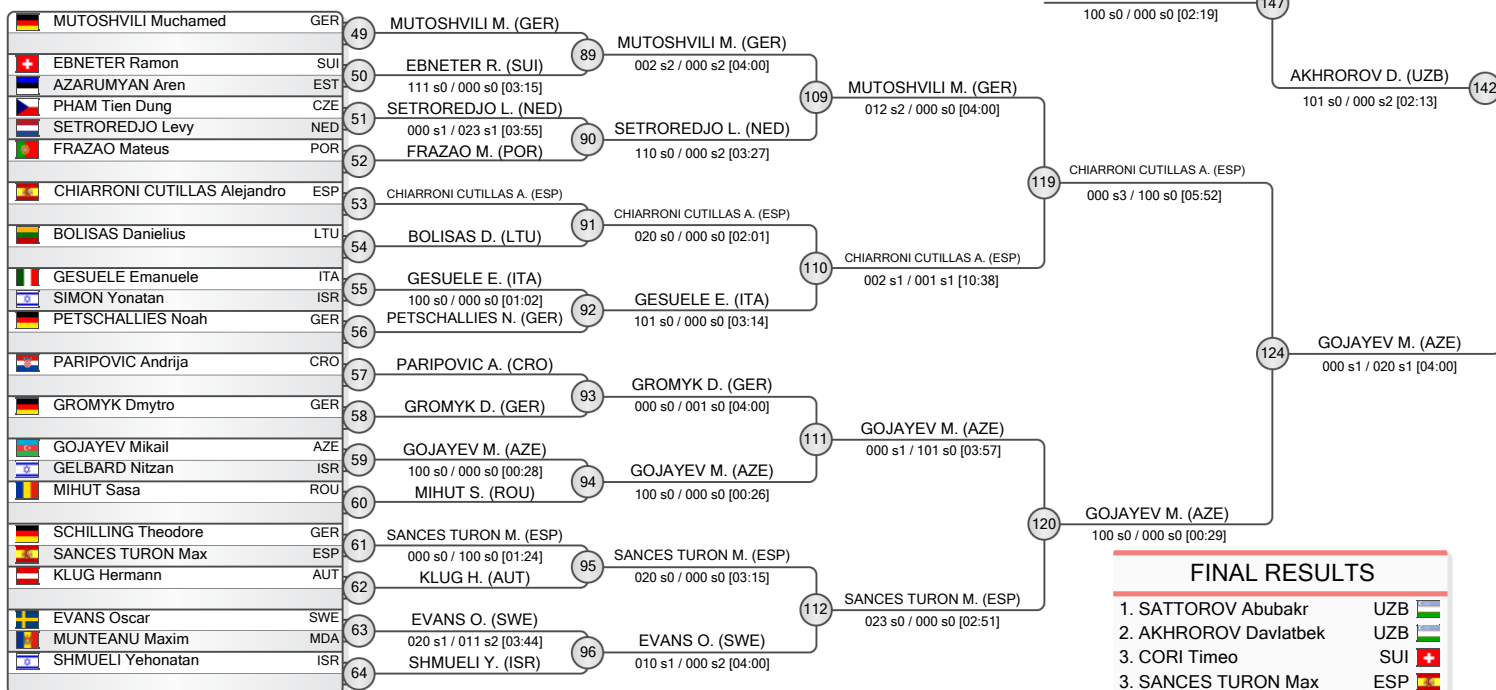

FINAL RESULTS

1. SATTOROV Abubakr UZB
2. AKHROROV Davlatbek UZB
3. CORI Timeo SUI
4. SANCES TURON Max ESP
5. GOJAYEV Mikail AZE
6. USINASHVILI Andro GEO
7. MARTZIANO Eyal ISR

REPECHAGE

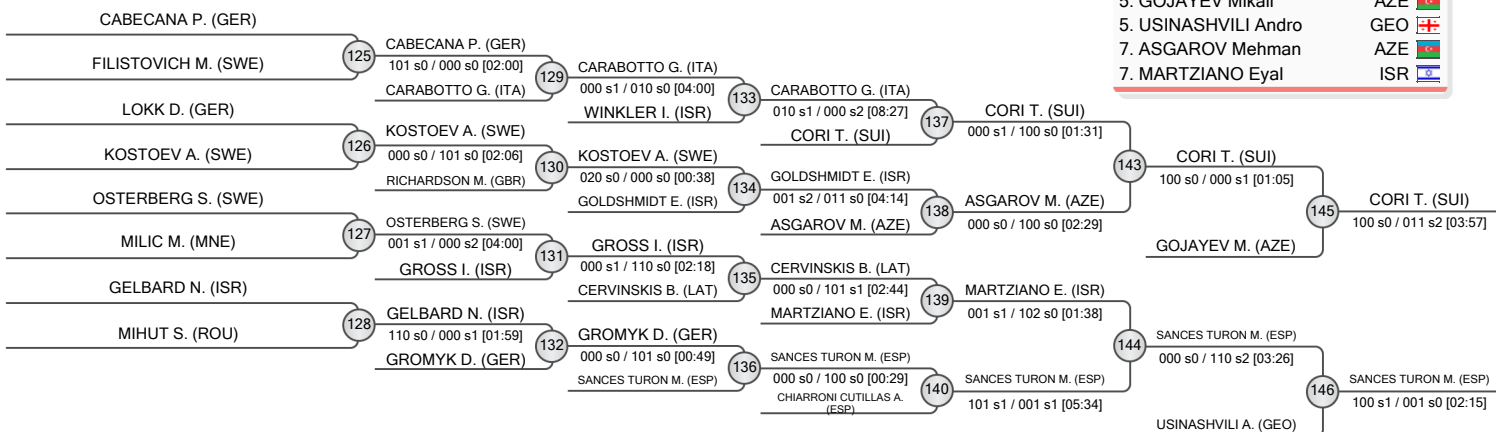



Berlin Millennium Team Cadet European Cup 2026

Germany, Berlin, 25-26 Apr 2026

-66 kg

Men (76)

POOL A

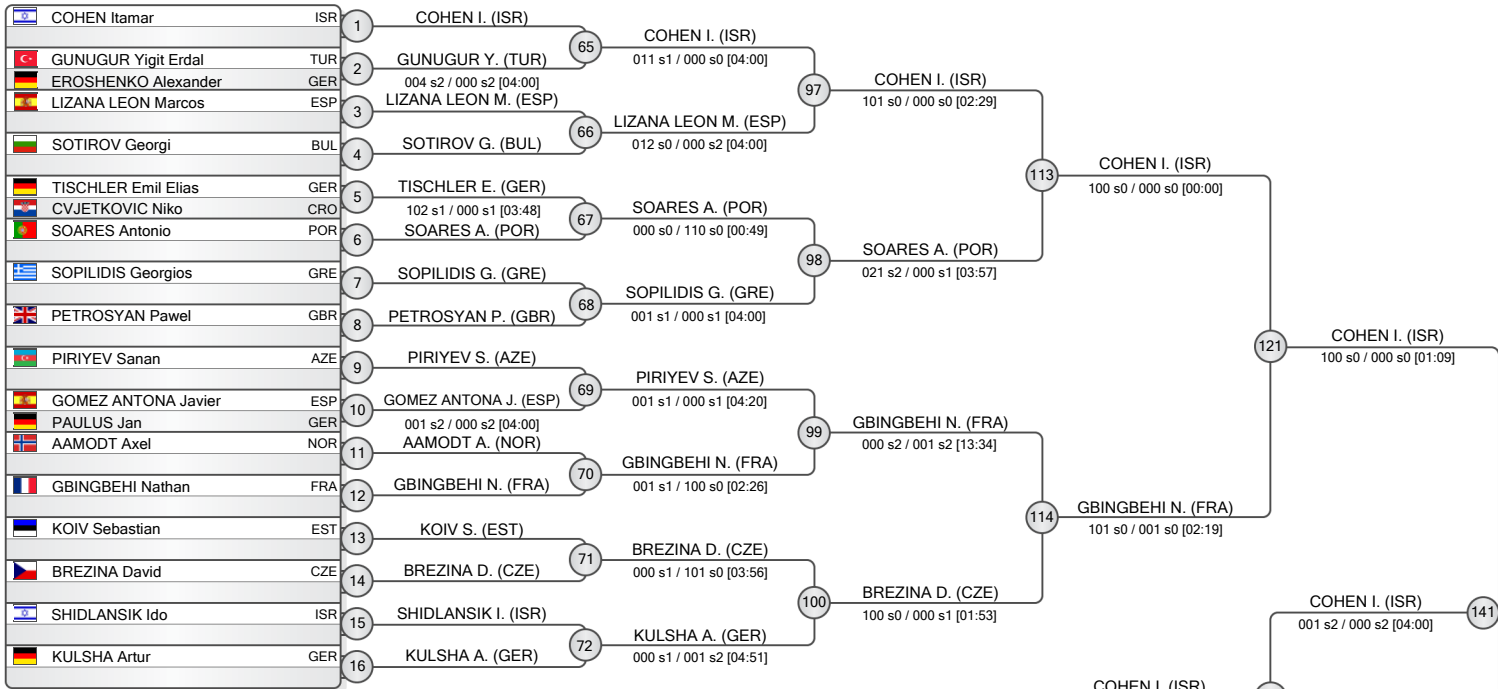

POOL B

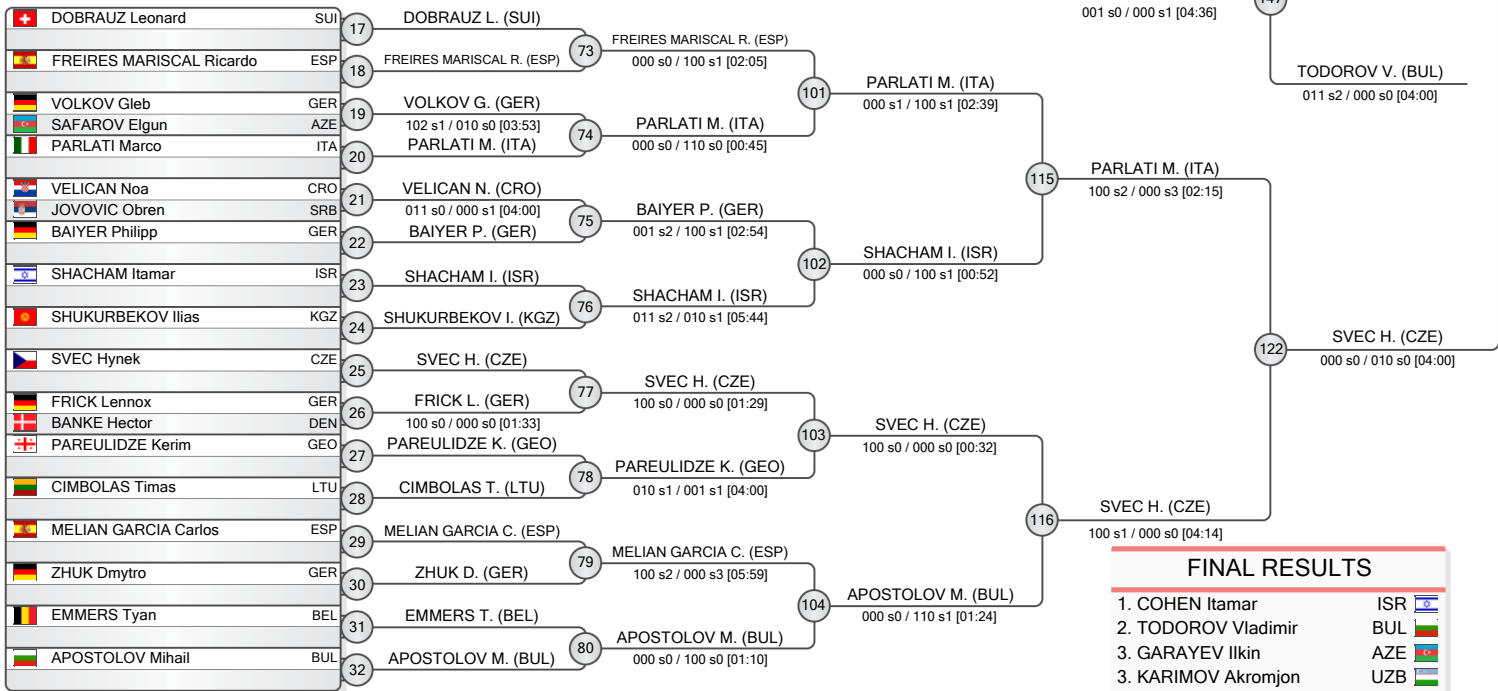

REPECHAGE

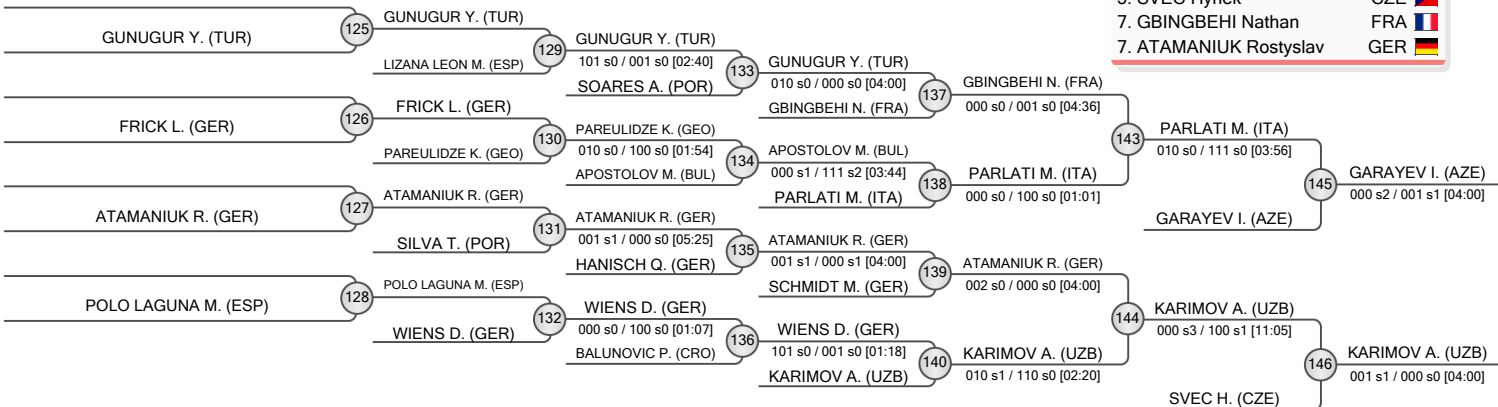

FINAL RESULTS

- COHEN I. (ISR)
- TODOROV V. (BUL)
- GARAYEV I. (AZE)
- KARIMOV A. (UZB)
- PARLATI M. (ITA)
- SVEC H. (CZE)
- GBINGBEHI Nathan (FRA)
- ATAMANIUK Rostyslav (GER)





Berlin Millennium Team Cadet European Cup 2026

Germany, Berlin, 25-26 Apr 2026

-73 kg

Men (62)

POOL A

1	RUSNAK Adam (CZE)	1	RUSNAK A. (CZE)	33	RUSNAK A. (CZE)	
2	KUTSON Kristjan (EST)	2	BOGAERT I. (BEL)	010 s1 / 000 s1 [04:00]	49	RUSNAK A. (CZE)
3	BOGAERT Ilkay (BEL)	3	MEYARA T. (ISR)	000 s1 / 010 s1 [06:20]	34	REUTFORS V. (SWE)
4	SCHERPING Maxim (GER)	4	REUTFORS V. (SWE)	000 s1 / 011 s0 [04:00]	35	MATUZNYI D. (GER)
5	MEYARA Tom (ISR)	5	MATUZNYI D. (GER)	100 s0 / 000 s0 [02:30]	50	MATUZNYI D. (GER)
6	REUTFORS Valter (SWE)	6	CECI E. (ITA)	101 s0 / 000 s0 [01:19]	36	TOSCHPULOTOV D. (GER)
7	KNEZEVIC Filip (MNE)	7	TOSCHPULOTOV D. (GER)	010 s2 / 011 s0 [04:11]	51	KILADZE L. (GER)
8	MATUZNYI Dmytro (GER)	8	MITOI S. (ROU)	100 s0 / 000 s0 [00:55]	52	EXMELIN E. (FRA)
9	HREN Adrian (CRO)	9	MARRERO TEJERA Yeremay (ESP)	100 s0 / 000 s1 [01:45]	40	EXMELIN E. (FRA)

POOL B

9	HRISTOFOROV Bruno (EST)	9	KILADZE L. (GER)	37	KILADZE L. (GER)	
10	KILADZE Lazare (GER)	10	DOKOV K. (BUL)	020 s0 / 000 s0 [01:39]	38	GILAD I. (ISR)
11	DOKOV Kiril (BUL)	11	GILAD I. (ISR)	111 s1 / 000 s1 [03:45]	39	KOKOEV KOKOEV B. (ESP)
12	MARTON Medard (ROU)	12	PAUSKIC S. (DEN)	100 s0 / 000 s0 [00:30]	40	EXMELIN E. (FRA)
13	GILAD Itay (ISR)	13	HOVEN Max Theodor (NOR)	020 s1 / 000 s1 [03:00]	41	NOGES G. (EST)
14	SANTOS Samuel (POR)	14	NAZAR Y. (AZE)	012 s2 / 000 s2 [04:00]	42	STOEGMANN S. (AUT)
15	PAUSKIC Silas (DEN)	15	KURTUMEROV Edem (GER)	002 s1 / 000 s0 [04:00]	43	STINER N. (ISR)
16	HOVEN Max Theodor (NOR)	16	KOKOEV KOKOEV Batraz (ESP)	000 s0 / 100 s2 [02:10]	44	MAMMADOV S. (AZE)
17	NAZAR Yusuf (AZE)	17	KURGHINYAN Misha (NED)	002 s1 / 000 s0 [04:00]	45	ESSADE A. (SUI)
18	KURTUMEROV Edem (GER)	18	AGRONOV Idan (ISR)	000 s0 / 100 s0 [01:42]	46	MCALEESE S. (GBR)
19	KOKOEV KOKOEV Batraz (ESP)	19	EXMELIN E. (FRA)	000 s0 / 100 s0 [01:42]	47	USMONOV B. (UZB)
20	KURGHINYAN Misha (NED)	20	MEDER-KURTOVIC Leon (AUT)	021 s0 / 000 s1 [03:32]	48	RAHIMOV K. (AZE)
21	AGRONOV Idan (ISR)	21	SCHUSTER Marek (GER)	110 s0 / 000 s0 [03:31]	49	ESSADE A. (SUI)
22	EXMELIN E. (FRA)	22	NOGES G. (EST)	010 s0 / 000 s0 [04:00]	50	ESSADE A. (SUI)
23	MEDER-KURTOVIC Leon (AUT)	23	SARZHANOV K. (KGZ)	000 s0 / 111 s0 [01:02]	51	STOEGMANN S. (AUT)
24	SCHUSTER Marek (GER)	24	STOEGMANN S. (AUT)	101 s0 / 000 s0 [03:23]	52	NISANOV M. (ISR)

POOL C

17	NOGES Georg (EST)	17	NOGES G. (EST)	41	NOGES G. (EST)	
18	LENNON Cole (GBR)	18	SARZHANOV K. (KGZ)	010 s0 / 000 s0 [04:00]	42	STOEGMANN S. (AUT)
19	SARZHANOV Kaisar (KGZ)	19	STOEGMANN S. (AUT)	100 s0 / 000 s0 [00:19]	43	STINER N. (ISR)
20	STOEGMANN Stefan (AUT)	20	NISANOV M. (ISR)	000 s0 / 020 s1 [03:17]	44	MAMMADOV S. (AZE)
21	MOLIM Mayron (FRA)	21	STINER N. (ISR)	020 s0 / 000 s0 [00:36]	45	ESSADE A. (SUI)
22	TSCHERHEIKO Mansur (GER)	22	ZHELJAZKOV D. (BUL)	100 s0 / 000 s0 [00:32]	46	MCALEESE S. (GBR)
23	NISANOV Maxim (ISR)	23	STEPINS Valters (LAT)	010 s2 / 002 s0 [04:00]	47	USMONOV B. (UZB)
24	STINER Noam (ISR)	24	SLAVINSKAS Reinas (LTU)	100 s0 / 000 s1 [02:20]	48	RAHIMOV K. (AZE)
25	HANSCHMANN Juri (GER)	25	KUBITZA Maximilian (GER)	000 s0 / 100 s0 [01:01]	49	ESSADE A. (SUI)
26	ZHELJAZKOV Dimitar (BUL)	26	MAMMADOV Sadig (AZE)	000 s0 / 100 s0 [01:01]	50	ESSADE A. (SUI)
27	STEPINS Valters (LAT)	27	STARING Eros (NED)	001 s2 / 000 s1 [04:20]	51	STOEGMANN S. (AUT)
28	SLAVINSKAS Reinas (LTU)	28	STARING Eros (NED)	001 s3 / 100 s2 [03:56]	52	NISANOV M. (ISR)
29	KUBITZA Maximilian (GER)	29	STARING Eros (NED)	010 s2 / 010 s3 [06:44]	53	STOEGMANN S. (AUT)
30	MAMMADOV Sadig (AZE)	30	STARING Eros (NED)	110 s2 / 010 s3 [06:44]	54	MAMMADOV S. (AZE)
31	STARING Eros (NED)	31	STARING Eros (NED)	010 s2 / 010 s3 [06:44]	55	ESSADE A. (SUI)

POOL D

25	NIKOLCHEV Ivan (BUL)	25	NIKOLCHEV I. (BUL)	45	ESSADE A. (SUI)
26	GOLOVKINS Denis (FRO)	26	GOLOVKINS D. (FRO)	46	MCALEESE S. (GBR)
27	ESSADE Antoine (SUI)	27	POHLMANN Willi-Balduin (GER)	47	USMONOV B. (UZB)
28	VULETIC Kevin (GER)	28	ALIKHANOV Amir (EST)	48	RAHIMOV K. (AZE)
29	POHLMANN Willi-Balduin (GER)	29	MURESAN Erik (ROU)	49	ESSADE A. (SUI)
30	ALIKHANOV Amir (EST)	30	MCALEESE Sean (GBR)	50	ESSADE A. (SUI)
31	MURESAN Erik (ROU)	31	SCHUERER Hannes (GER)	51	STOEGMANN S. (AUT)
32	MCALEESE Sean (GBR)	32	BARBALATA Mario Florin (ITA)	52	NISANOV M. (ISR)
33	SCHUERER Hannes (GER)	33	USMONOV Bekhruzbek (UZB)	53	STOEGMANN S. (AUT)
34	BARBALATA Mario Florin (ITA)	34	VOJVODA Divo (CRO)	54	MAMMADOV S. (AZE)
35	USMONOV Bekhruzbek (UZB)	35	STANJA Jonathan (GER)	55	ESSADE A. (SUI)
36	VOJVODA Divo (CRO)	36	RAHIMOV Kanan (AZE)	56	USMONOV B. (UZB)
37	STANJA Jonathan (GER)	37	SANUDO SAMPERIO Dario (ESP)	57	STOEGMANN S. (AUT)
38	RAHIMOV Kanan (AZE)	38	MOLOMAN Sagi (ISR)	58	KILADZE L. (GER)
39	SANUDO SAMPERIO Dario (ESP)	39	MOLOMAN Sagi (ISR)	59	MAMMADOV S. (AZE)
40	MOLOMAN Sagi (ISR)	40	MOLOMAN Sagi (ISR)	60	USMONOV B. (UZB)

REPECHAGE

61	HREN A. (CRO)	61	CECI E. (ITA)	65	CECI E. (ITA)
62	CECI E. (ITA)	62	TOSCHPULOTOV D. (GER)	66	HRISTOFOROV B. (EST)
63	HRISTOFOROV B. (EST)	63	HRISTOFOROV B. (EST)	67	STARING E. (NED)
64	DOKOV K. (BUL)	64	GILAD I. (ISR)	68	SCHUERER H. (GER)
65	STARING E. (NED)	65	STARING E. (NED)	69	CECI E. (ITA)
66	SLAVINSKAS R. (LTU)	66	STARING E. (NED)	70	HRISTOFOROV B. (EST)
67	VOJVODA D. (CRO)	67	STINER N. (ISR)	71	STARING E. (NED)
68	SCHUERER H. (GER)	68	SCHUERER H. (GER)	72	SCHUERER H. (GER)
69	CECI E. (ITA)	69	RAHIMOV K. (AZE)	73	MAMMADOV S. (AZE)
70	HRISTOFOROV B. (EST)	70	ESSADE A. (SUI)	74	MAMMADOV S. (AZE)
71	STARING E. (NED)	71	ESSADE A. (SUI)	75	HRISTOFOROV B. (EST)
72	SCHUERER H. (GER)	72	ESSADE A. (SUI)	76	STARING E. (NED)
73	MAMMADOV S. (AZE)	73	ESSADE A. (SUI)	77	USMONOV B. (UZB)
74	MAMMADOV S. (AZE)	74	ESSADE A. (SUI)	78	STARING E. (NED)
75	HRISTOFOROV B. (EST)	75	ESSADE A. (SUI)	79	MATUZNYI D. (GER)
76	STARING E. (NED)	76	ESSADE A. (SUI)		
77	USMONOV B. (UZB)	77	ESSADE A. (SUI)		
78	STARING E. (NED)	78	ESSADE A. (SUI)		
79	MATUZNYI D. (GER)	79	ESSADE A. (SUI)		

FINAL RESULTS

- MATUZNYI Dmytro (GER)
- MAMMADOV Sadig (AZE)
- USMONOV Bekhruzbek (UZB)
- STARING Eros (NED)
- HRISTOFOROV Bruno (EST)
- KILADZE Lazare (GER)
- CECI Emiliano (ITA)
- SCHUERER Hannes (GER)





Berlin Millennium Team Cadet European Cup 2026

Germany, Berlin, 25-26 Apr 2026

-81 kg

Men (59)

POOL A

	KIKAS Aleksei	EST
	SATOROVIC Emir	AUT
	WIESENBERGER Till Louis	GER
	HASANLI Aykhan	AZE
	VAN WOENSEL Ties	NED
	MADSEN Emil	DEN
	ADAMEC Maxmilian Tomas	CZE
	ROSENBERG Yoav	ISR
	NURTILEKOV Elgazy	KGZ
	BECK Flynt	GER
	PETRE David	ROU
	POPIVODA Vukan	MNE
	NUX Alexandre	FRA
	NURM August Martin	EST
	OSMANI Mensur	GER

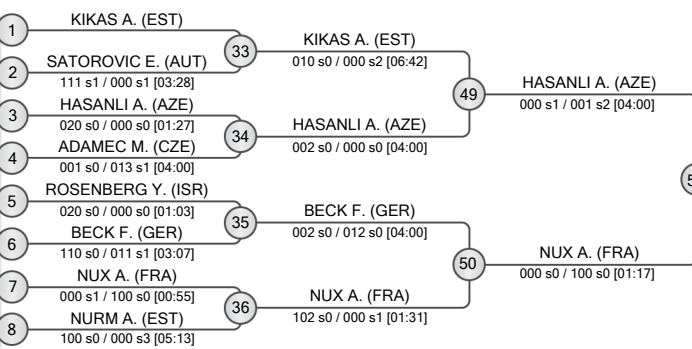

POOL B

	TOOMEL Joosep	EST
	MATTSSON Kalle	SWE
	KILADZE Giga	GER
	SILLAH Moise	GER
	KRMEK Roko Ivan	CRO
	PUGH Harvey	GBR
	SUPAKHUNOV David	LTU
	MAMMADOV Yagub	AZE
	KATSARSKI Teodor	BUL
	SCHWENKE Johann	GER
	GKOLIAS Efthymios	GRE
	HARCAVI Adam	ISR
	FENSKI Ole	GER
	SILLAR Richard	EST

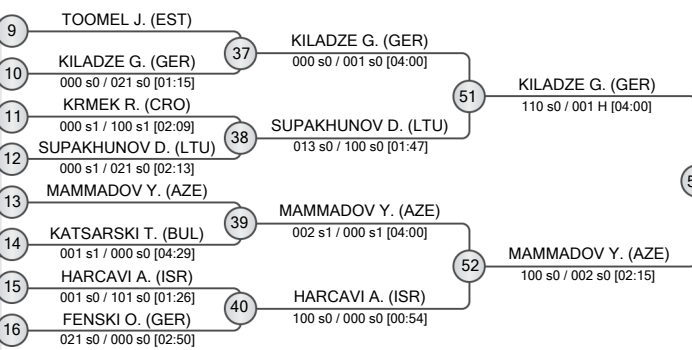

POOL C

	MEHDIYEV Amin	AZE
	MOOR Louis-Alexander	GER
	ERIKSON Mattias	EST
	ERLICH Roland	GER
	ISAKOV Baiel	KGZ
	IURCOVSCHI Daniel	FRA
	NAGY Akos	ROU
	HASANLI Polad	AZE
	AHRENS Jan Alexander	GER
	PODKUJKO Igors	LAT
	FARFELEDER Samuel	AUT
	KOEVER Siim	EST
	DAVIDASHVILY Yakov	ISR
	FACHIRIDIS Stavros	GER
	SILVA Vicente	POR

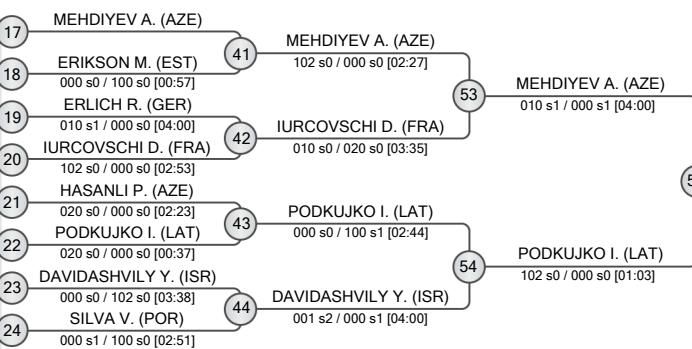

POOL D

	VALA Lukas	CZE
	VAN DER KROON Jan	NED
	UNTERBERG Lev	GER
	PONOMARENKO Ivan	GER
	MCGIVERN Aodhan	GBR
	MATHUES Sid	BEL
	CANEPARI Riccardo	ITA
	SUNNATOV Samandar	UZB
	SEIDELBERG Marten	EST
	DIMITROV Plamen	BUL
	MINICH Michail	GER
	KRZELJ Dante	CRO
	BEN SHITRIT Ehud	ISR
	KUNSZABO Matei	ROU
	KARAZELIDIS Pavlos	GER

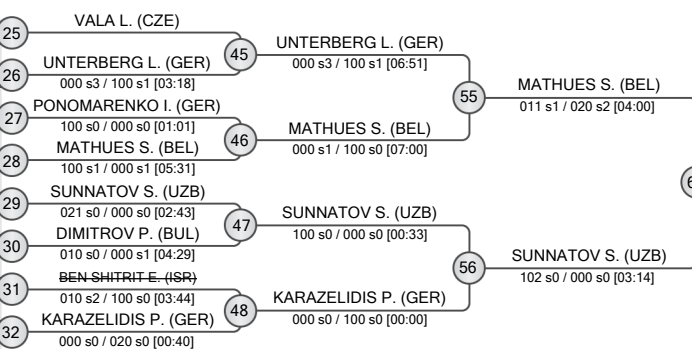

REPECHAGE

VAN WOENSEL T. (NED)	61
ADAMEC M. (CZE)	62
KATSARSKI T. (BUL)	63
ERIKSON M. (EST)	64
SEIDELBERG M. (EST)	65
DIMITROV P. (BUL)	66

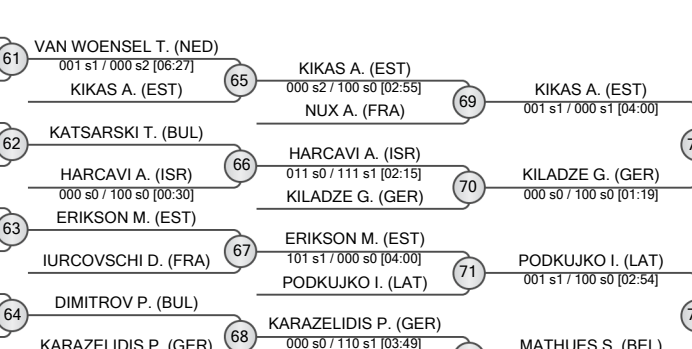

FINAL RESULTS		
1.	SUNNATOV Samandar	UZB
2.	HASANLI Aykhan	AZE
3.	MEHDIYEV Amin	AZE
4.	MAMMADOV Yagub	AZE
5.	KILADZE Giga	GER
5.	MATHUES Sid	BEL
7.	KIKAS Aleksei	EST
7.	PODKUJKO Igors	LAT





Berlin Millennium Team Cadet European Cup 2026

Germany, Berlin, 25-26 Apr 2026

-90 kg

Men (34)

POOL A

	BABAICENKO Tajus	LTU	1	BABAICENKO T. (LTU)
	CLEDJO Mathys	BEL	2	CLEDJO M. (BEL)
	BEYELER Gabriel	SUI	3	BEYELER G. (SUI)
	KHABIR Mehdi	FRA	4	KHABIR M. (FRA)
	YRYSOLOTOV Mukhammedali	KGZ	5	YRYSOLOTOV M. (KGZ)
	NAUTA Jacob	NED	6	NAUTA J. (NED)
	GRAEBER Julian	GER	7	GRAEBER J. (GER)
	SEBELKA Hugo	CZE	8	SEBELKA H. (CZE)

POOL B

	MARKOVIC Arian	CRO	9	MARKOVIC A. (CRO)
	TRUUVERK Huud-Keerit	EST	10	TRUUVERK H. (EST)
	NIELSEN Holger	DEN	11	SHNIDER O. (ISR)
	SHNIDER Omer	ISR	11	SHNIDER O. (ISR)
	WOERMANSEDER Johannes	AUT	12	WOERMANSEDER J. (AUT)
	KOLOSOVS Dmitrijs	LAT	13	KOLOSOVS D. (LAT)
	SEGUIN RENDAL Ian	ESP	14	SEGUIN RENDAL I. (ESP)
	ALIYEV Nuraddin	AZE	15	ALIYEV N. (AZE)
	AL-HASSANI Saged	GER	16	AL-HASSANI S. (GER)

POOL C

	ESHPULATOV Jurabek	UZB	17	ESHPULATOV J. (UZB)
	LEETSAR Kaur	EST	18	LEETSAR K. (EST)
	KONOPLYANYK Nikolai	BEL	19	KONOPLYANYK N. (BEL)
	EMILOV Bobi	BUL	20	EMILOV B. (BUL)
	SIGNORINI Nicolo	ITA	21	SIGNORINI N. (ITA)
	VRABETZ Alexander	AUT	22	BOOMKAMP M. (NED)
	BOOMKAMP Marinus	NED	22	BOOMKAMP M. (NED)
	ALBRECHT Anton	GER	23	ALBRECHT A. (GER)
	SIDLAUSKAS Jokubas	LTU	24	SIDLAUSKAS J. (LTU)

POOL D

	SCHEIBER Felix	AUT	25	SCHEIBER F. (AUT)
	AKHUNDOV Omar	AZE	26	AKHUNDOV O. (AZE)
	KISSK Julian Henryk	GER	27	KISSK J. (GER)
	AMACIN Marlone	FRA	28	AMACIN M. (FRA)
	GOLTZ Jerome	GER	29	GOLTZ J. (GER)
	FERNANDEZ CALERO Pablo	ESP	30	FERNANDEZ CALERO P. (ESP)
	GARAGAU Razvan	ROU	31	GARAGAU R. (ROU)
	LAJCAK Ondrej	CZE	32	LAJCAK O. (CZE)

REPECHAGE

CLEDJO M. (BEL)	61	CLEDJO M. (BEL)	65	CLEDJO M. (BEL)	69	YRYSOLOTOV M. (KGZ)	75	YRYSOLOTOV M. (KGZ)	77	YRYSOLOTOV M. (KGZ)
SEGUIN RENDAL I. (ESP)	62	SEGUIN RENDAL I. (ESP)	66	ALIYEV N. (AZE)	70	ALIYEV N. (AZE)	76	SCHEIBER F. (AUT)	78	SCHEIBER F. (AUT)
LEETSAR K. (EST)	63	LEETSAR K. (EST)	67	LEETSAR K. (EST)	71	BOOMKAMP M. (NED)	72	SCHEIBER F. (AUT)		
SCHEIBER F. (AUT)	64	SCHEIBER F. (AUT)	68	KISSK J. (GER)	72	LAJCAK O. (CZE)				

FINAL RESULTS

- BABAICENKO Tajus (LTU)
- AKHUNDOV Omar (AZE)
- YRYSOLOTOV Mukhammedali (KGZ)
- SCHEIBER Felix (AUT)
- ESHPULATOV Jurabek (UZB)
- KOLOSOVS Dmitrijs (LAT)
- ALIYEV Nuraddin (AZE)
- BOOMKAMP Marinus (NED)





Berlin Millennium Team Cadet European Cup 2026

Germany, Berlin, 25-26 Apr 2026

+ 90 kg

Men (20)

POOL A

	SKODA Melichar	CZE
	KIASUMBUA Eilijah	FRA
	IKMAN Den	ISR
	TEGELAAR Jack	SWE
	THAMM Max Anton	GER

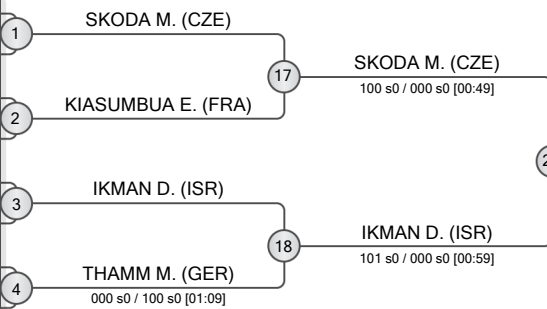

POOL B

	TOLIBAEV Ersultan	UZB
	SOM Samuel	FRA
	LOBATO PEREZ Aimar	ESP
	BADEA Petru	ROU
	BRUINING Joshua	NED

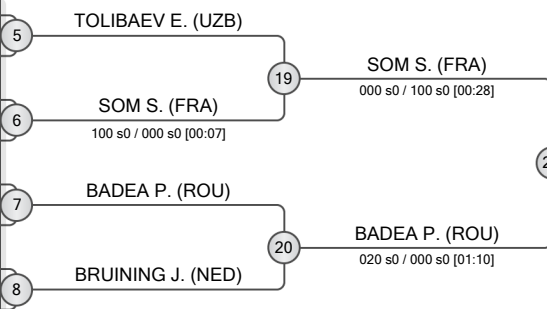

POOL C

	APSALONS Aleksandrs	LAT
	LODDES Romet	EST
	BRUNNER Jan	CZE
	RIETDIJK Keano	NED
	STETTINSKY Lucas	GER

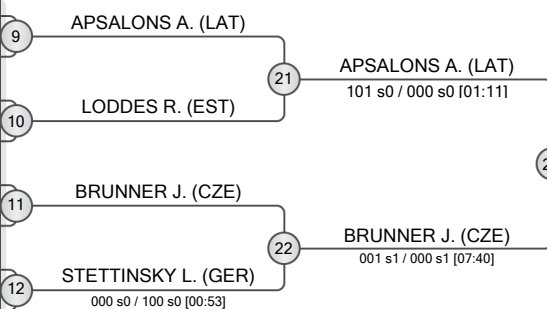

POOL D

	ALIYEV Tamerlan	AZE
	SAURA Nathan	FRA
	BRAUSEWETTER Maarten	GER
	KAZIMOV Ruslan	AZE
	BOLOTBEKOV Altynbek	KGZ

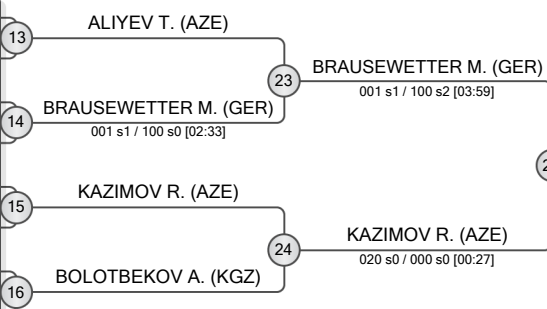

REPECHAGE

29	KIASUMBUA E. (FRA)
30	BRUINING J. (NED)
31	LODDES R. (EST)
32	BOLOTBEKOV A. (KGZ)
33	IKMAN D. (ISR)
34	SOM S. (FRA)
35	BRUNNER J. (CZE)
36	BRAUSEWETTER M. (GER)

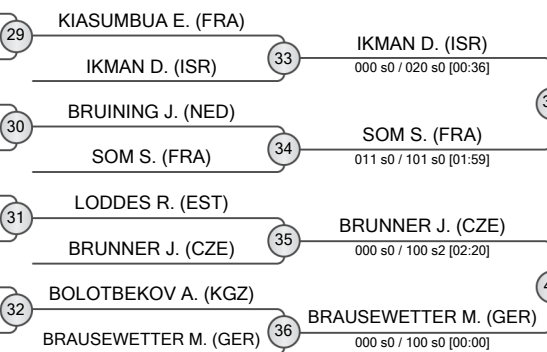

FINAL RESULTS		
1.	SKODA Melichar	CZE
2.	APSALONS Aleksandrs	LAT
3.	KAZIMOV Ruslan	AZE
3.	BADEA Petru	ROU
5.	SOM Samuel	FRA
7.	BRUNNER Jan	CZE
7.	IKMAN Den	ISR
7.	BRAUSEWETTER Maarten	GER





Berlin Millennium Team Cadet European Cup 2026

Germany, Berlin, 25-26 Apr 2026

-40 kg

Women (16)

POOL A

	GRACOVA Dominika	CZE
	BARRAY Jade	FRA
	BREM Nawaii	NED
	CRACIUN Ana Maria	ROU

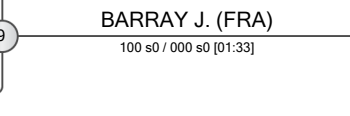
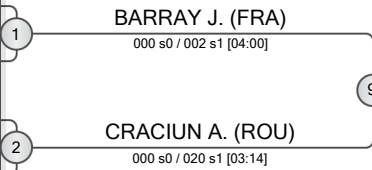

POOL B

	KARAKAZAN Elcin	TUR
	EMMERLING Greta	GER
	SIROJIDDINOVA Iroda	UZB
	GULIYEVA Zahra	AZE

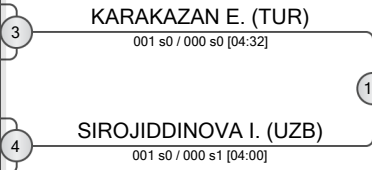

POOL C

	TOKMAK Havva Sena	TUR
	MOUSSATI Assia	FRA
	SALAMOVA Sunay	AZE
	PHAM Serra	NED

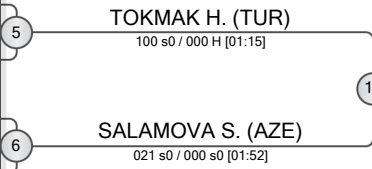

POOL D

	GAT MUALEM Avigayil	ISR
	BALANEAN Stefania	ROU
	COSTA CABANA Candela	ESP
	SCHEIDA Julia	GER

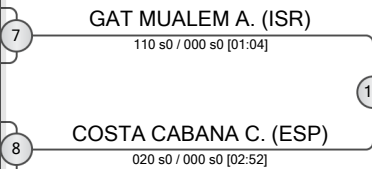

FINAL RESULTS		
1.	BARRAY Jade	FRA
2.	SALAMOVA Sunay	AZE
3.	SIROJIDDINOVA Iroda	UZB
3.	TOKMAK Havva Sena	TUR
5.	GAT MUALEM Avigayil	ISR
5.	KARAKAZAN Elcin	TUR
7.	GRACOVA Dominika	CZE
7.	COSTA CABANA Candela	ESP

REPECHAGE

GRACOVA D. (CZE)	13	GRACOVA D. (CZE) 100 s0 / 000 s0 [00:58]
CRACIUN A. (ROU)	14	SIROJIDDINOVA I. (UZB) 001 s0 / 020 s0 [01:15]
EMMERLING G. (GER)	15	TOKMAK H. (TUR) 001 s0 / 020 s0 [01:15]
SIROJIDDINOVA I. (UZB)	16	COSTA CABANA C. (ESP) 001 s0 / 020 s0 [01:15]
PHAM S. (NED)	19	SIROJIDDINOVA I. (UZB) 001 s0 / 101 s0 [04:29]
TOKMAK H. (TUR)	20	TOKMAK H. (TUR) 001 s0 / 000 s1 [04:08]
BALANEAN S. (ROU)	21	SIROJIDDINOVA I. (UZB) 101 s0 / 000 s1 [03:28]
COSTA CABANA C. (ESP)	22	TOKMAK H. (TUR) 011 s0 / 010 s0 [04:00]

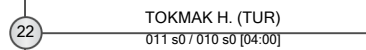
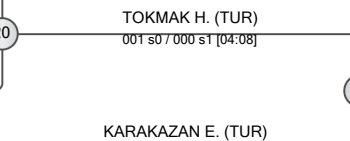
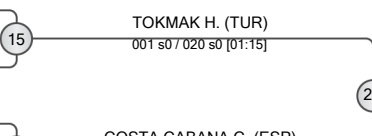
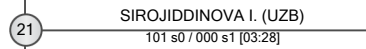
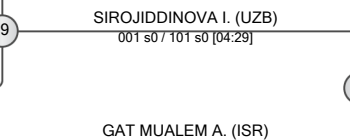
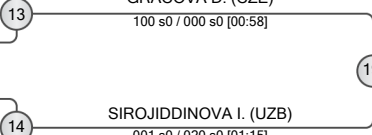



Berlin Millennium Team Cadet European Cup 2026

Germany, Berlin, 25-26 Apr 2026

-44 kg

Women (31)

POOL A

	LONGO Sofia	ITA
	MICHI Vivian Marie	GER
	HEYDARZADE Nigar	AZE
	DAVIS Katrina	GBR
	BROUNEN Fem	NED
	BIRINCI Hiranur	TUR
	SOFFER Lihi	ISR

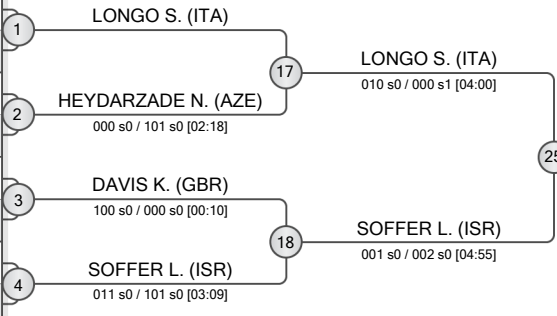

POOL B

	CONI Sara	ITA
	LUDVIG Amalia	ROU
	Soubielle Maia	FRA
	SAMARDZHIDI Anna	AUT
	PEETERS Fenne	BEL
	KOLUCHEVA Alina	UZB
	MONZO PASCUAL Marta	ESP
	STEPANOVA Anastasiia	KGZ

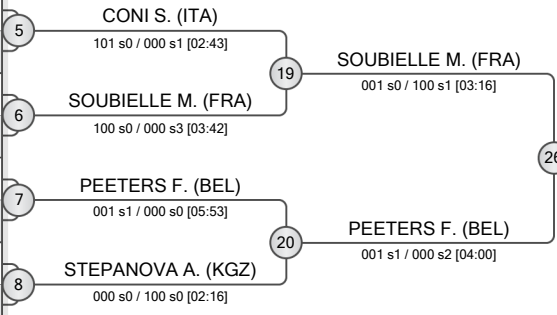

POOL C

	YILMAZTURK Yagmur	TUR
	ITSKOV Rivka	ISR
	HISSETTE Nell	BEL
	KILACKOVA Silvia	SVK
	ABDULLAYEVA Fatima	AZE
	MARIAN Daria	ROU
	BOLTABOEVA Dilafuz	UZB
	GRAVENSTIJN Tracey	NED

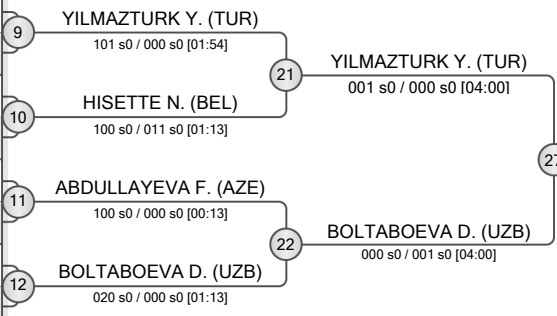

POOL D

	MANASBEKOVA Munira	KGZ
	VALVERDE DURAN Claudia	ESP
	SEVKHANLI Parvin	AZE
	SAMARDZHIDI Maria	AUT
	CIUMAS Bianca	ROU
	DEEB Leia	GER
	SURDEZ KAUL Zelig	FRA
	OSTERBERG Josephine	SWE

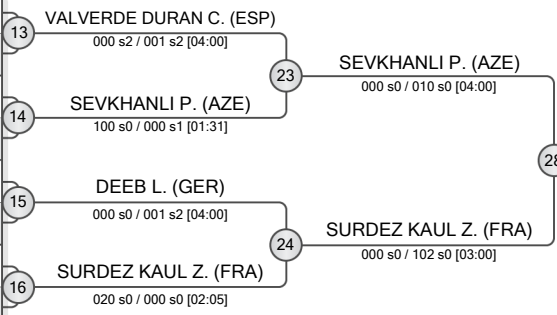

FINAL RESULTS	
1.	YILMAZTURK Yagmur TUR
2.	LONGO Sofia ITA
3.	SEVKHANLI Parvin AZE
3.	BOLTABOEVA Dilafuz UZB
5.	CONI Sara ITA
7.	Soubielle Maia FRA
7.	SOFFER Lihi ISR
7.	VALVERDE DURAN Claudia ESP

REPECHAGE

HEYDARZADE N. (AZE) 29	HEYDARZADE N. (AZE)	SOFFER L. (ISR) 33	SOFFER L. (ISR)
SAMARDZHIDI A. (AUT) 30	CONI S. (ITA)	CONI S. (ITA) 34	CONI S. (ITA)
CONI S. (ITA) 30	PEETERS F. (BEL)	PEETERS F. (BEL) 34	PEETERS F. (BEL)
ITSKOV R. (ISR) 31	HISSETTE N. (BEL)	HISSETTE N. (BEL) 35	HISSETTE N. (BEL)
HISSETTE N. (BEL) 31	BOLTABOEVA D. (UZB)	BOLTABOEVA D. (UZB) 35	BOLTABOEVA D. (UZB)
SAMARDZHIDI M. (AUT) 32	VALVERDE DURAN C. (ESP)	VALVERDE DURAN C. (ESP) 36	VALVERDE DURAN C. (ESP)
VALVERDE DURAN C. (ESP) 32	SURDEZ KAUL Z. (FRA)	SURDEZ KAUL Z. (FRA) 36	SURDEZ KAUL Z. (FRA)

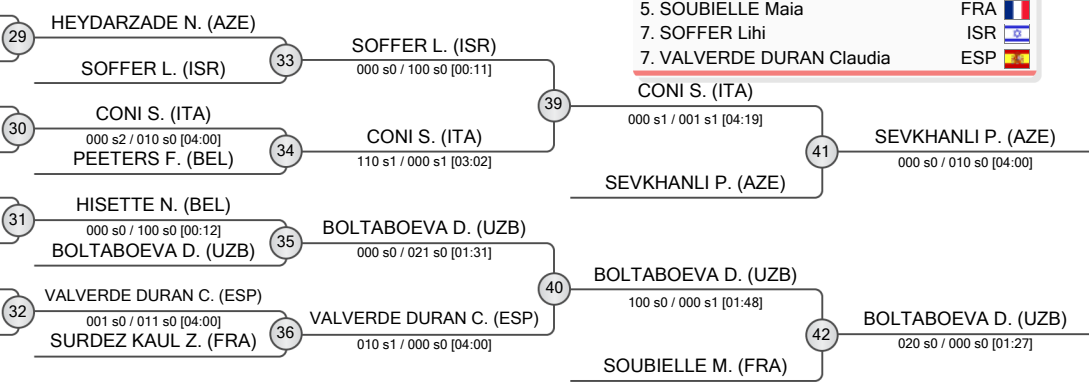



Berlin Millennium Team Cadet European Cup 2026

Germany, Berlin, 25-26 Apr 2026

-48 kg

Women (37)

POOL A

	NOY Agam Sol	ISR
	NIJHUIS Jelena	NED
	ZEYNALOVA Sakina	AZE
	DOE Betsy	GBR
	CARVALHO Mariana	POR
	COSKUN Busra Ceylin	TUR
	KUNYIK Laura-Sophie	AUT
	MARTINEZ Navia	BEL
	BRUNETT Hanna	GER

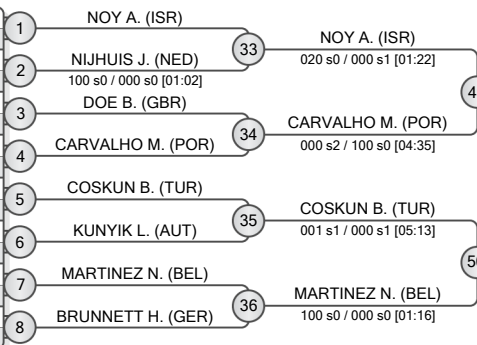

POOL B

	HIKMATOVA Charos	UZB
	KRATZER Helene	GER
	STEFANIE Mamitantly Oceana	FRA
	ROGOJINARU Adelina	ROU
	BIRGER Ella	ISR
	STORIONE Ludovica	ITA
	SOARES Maria	POR
	SANTIN MORENO Miriam	ESP
	WIJK Alma	SWE
	GORANOVIC Katarina	SRB

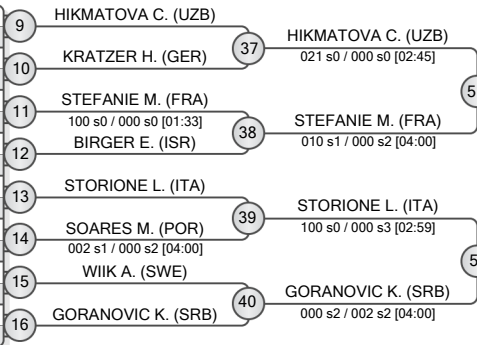

POOL C

	STARK Leeyam	ISR
	KOEPPEN Jane	GER
	WAHLSTROM Selma	SWE
	GRIGORYAN Viktoria	BEL
	BEERMANN Mia Marie	GER
	FONSBOEL Elena	DEN
	REMIGIO RUIZ Nadia	ESP
	BUCHANAN Alexis	GBR
	VALKAUSKAITE Vismante	LTU

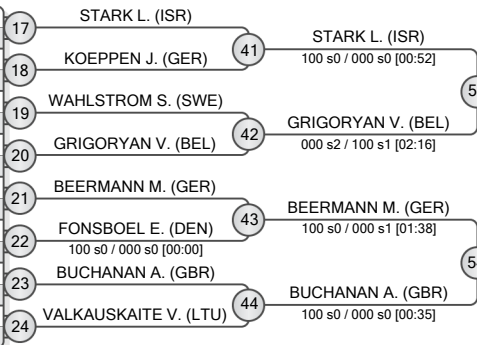

POOL D

	EYVAZLI Konul	AZE
	MANTAIEVA Jasmina	AUT
	BELTRAN MARUENDA Ivet	ESP
	TIXIER Line	FRA
	FRANCO Carolina	POR
	AZARUMYAN Anna	EST
	FALDT Lova	SWE
	STEINBERG Michelle	GER
	KATUSIC Nika	CRO

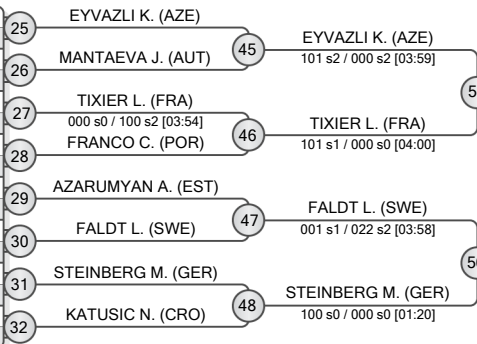

REPECHAGE

	NIJHUIS J. (NED)	61	NIJHUIS J. (NED)	65	NIJHUIS J. (NED)	69
	KRATZER H. (GER)	62	KRATZER H. (GER)	66	STEFANIE M. (FRA)	70
	WAHLSTROM S. (SWE)	63	WAHLSTROM S. (SWE)	67	BEERMANN M. (GER)	71
	MANTAIEVA J. (AUT)	64	MANTAIEVA J. (AUT)	68	MANTAIEVA J. (AUT)	72

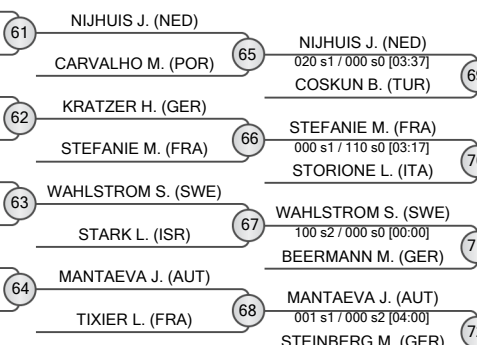

FINAL RESULTS		
1.	HIKMATOVA Charos	
2.	GRIGORYAN Viktoria	
3.	STEFANIE Mamitantly Oceana	
3.	NOY Agam Sol	
5.	EYVAZLI Konul	
5.	BEERMANN Mia Marie	
7.	NIJHUIS Jelena	
7.	MANTAIEVA Jasmina	

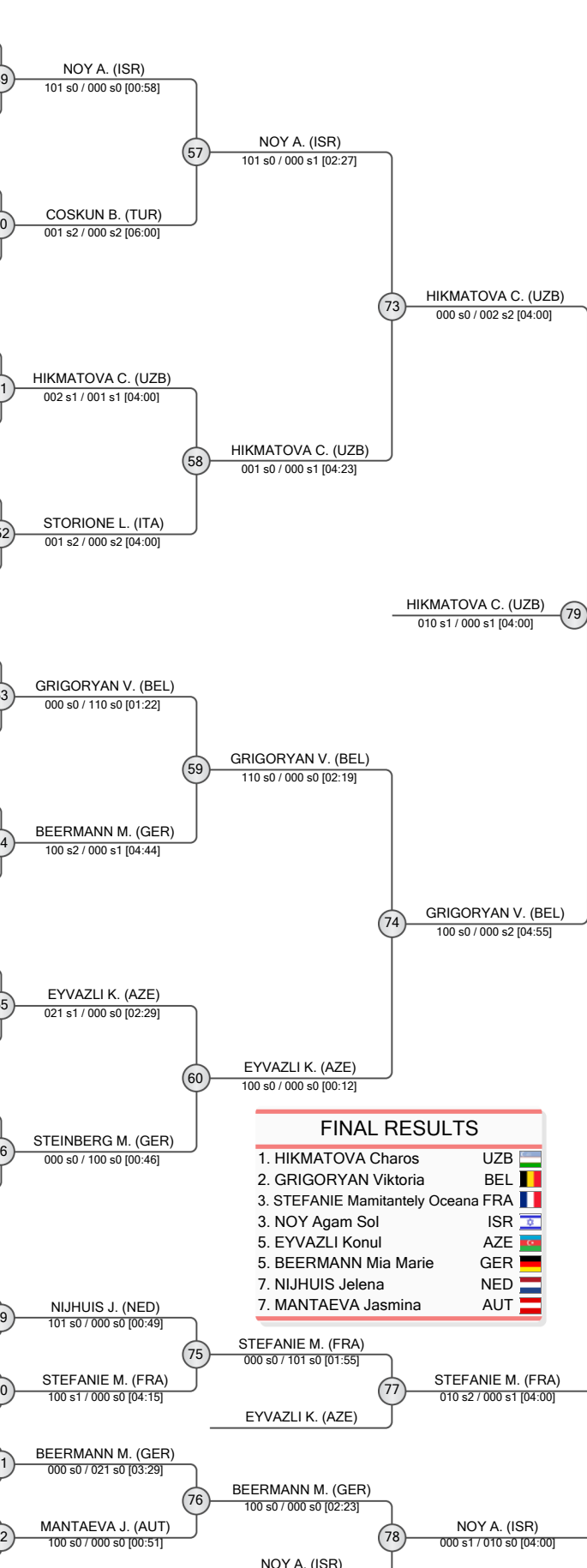



Berlin Millennium Team Cadet European Cup 2026

Germany, Berlin, 25-26 Apr 2026

-52 kg

Women (45)

POOL A

CHIRON Alexandra	MDA
KRZYZANIAK Zoe	GER
MARTIN TORRES Jimena	ESP
AKERSTROM Thelma	SWE
GUION Sofia	ITA
GOECKERITZ Leni	GER
SOUSA LAVANDEIRA Zeltia	ESP
WELLEKENS Amelie	BEL
KING Hannah	GBR
GUPALO Liana	GER
DOUMBIA Salma	FRA

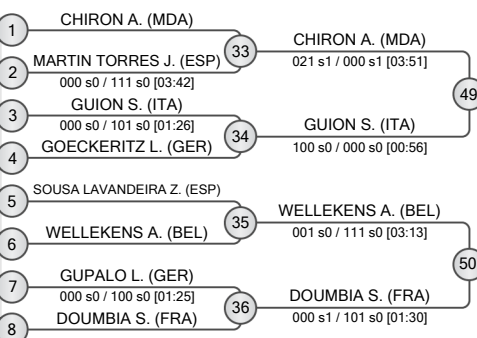

POOL B

TUERK Helin	AUT
BUZINA Anastasia	EST
PETERSON Elsa	SWE
REITMANN Anna	GER
WOLSTER Gili Racheli	ISR
BROADLEY Maisie	GBR
AGHAMIRZAZADE Narmin	AZE
GERINGER Xenia	GER
TERES CEREZA Daniela	ESP
VAN DE RIJZEN Lieve	NED
WOERNER Daphne	GER

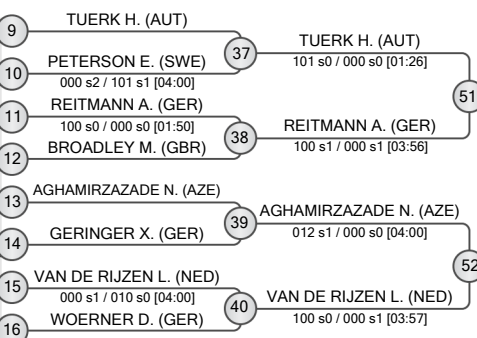

POOL C

YAHAV Yali	ISR
BABAYEVA Tovsiyya	AZE
LAMM Valentina	AUT
MANTYKENTTA Sara	FIN
LARSEN Ria	SUI
KUKIC Lana	GER
BOSKUP Aysenur	TUR
TSIONARAS Dora Eleana	GER
HELGESSION Emilia	SWE
VAINER Xenia	MDA
LOPEZ GORDO Sofia	ESP
JAEGER Sophie	GER

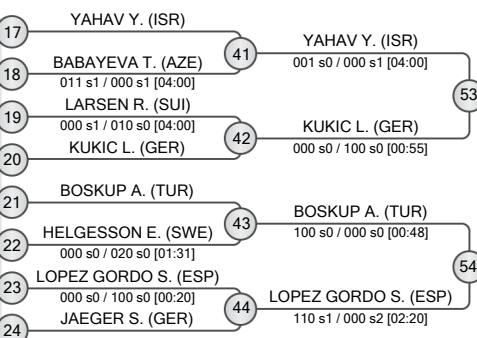

POOL D

VUKASOVIC Teodora	SRB
WEGELER Babette	GER
GRUBER Michelle	GER
CUSA Carla	ROU
PAUS Roni	ISR
FINDRIK Paula	CRO
DUBOSQ Ambre	FRA
ROMERA BARRAGAN Aniana	ESP
CEDERVALL CLAESSION Tilde	SWE
DALY Lucy	GBR
FOERSTER Mia	GER

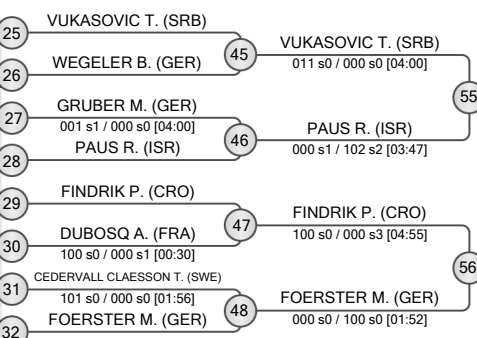

REPECHAGE

MARTIN TORRES J. (ESP)	61	MARTIN TORRES J. (ESP)
GERINGER X. (GER)	62	GERINGER X. (GER)
HELGESSION E. (SWE)	63	HELGESSION E. (SWE)
WEGELER B. (GER)	64	WEGELER B. (GER)

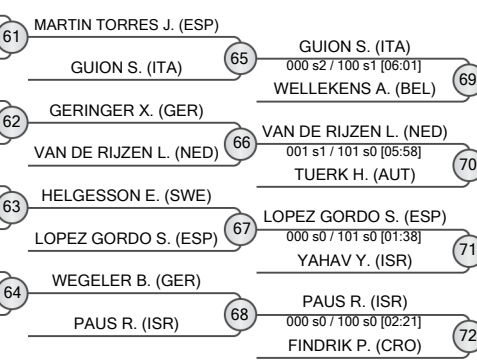

FINAL RESULTS		
1.	CHIRON Alexandra	MDA
2.	VUKASOVIC Teodora	SRB
3.	BOSKUP Aysenur	TUR
3.	AGHAMIRZAZADE Narmin	AZE
5.	VAN DE RIJZEN Lieve	NED
5.	YAHAV Yali	ISR
7.	WELLEKENS Amelie	BEL
7.	FINDRIK Paula	CRO





Berlin Millennium Team Cadet European Cup 2026

Germany, Berlin, 25-26 Apr 2026

-57 kg

Women (58)

POOL A

KILIC Elif	TUR
BOUVIL Clarisse	FRA
VAN BAAL Sijmmie	NED
EVERS Josephine	GER
NATARIO Maria	POR
YUSIFLI Samaya	AZE
VENDRELL JUAN Alexia	ESP
SHATTOCK Maisie	GBR
BAECHLE Sophia	GER
JANSEN Marie-Lise	BEL
MELAMED Lee	ISR
ALIMOVA Zuhra	UZB
BLANK Emilia	GER
KILDEEVA Daria	FIN
BORUBOLOTOVA Milena	KGZ

1	KILIC E. (TUR)	33	KILIC E. (TUR)
2	VAN BAAL S. (NED)	34	YUSIFLI S. (AZE)
3	EVERS J. (GER)	35	BAECHLE S. (GER)
4	YUSIFLI S. (AZE)	36	ALIMOVA Z. (UZB)
5	BAECHLE S. (GER)		
6	JANSEN M. (BEL)		
7	ALIMOVA Z. (UZB)		
8	KILDEEVA D. (FIN)		

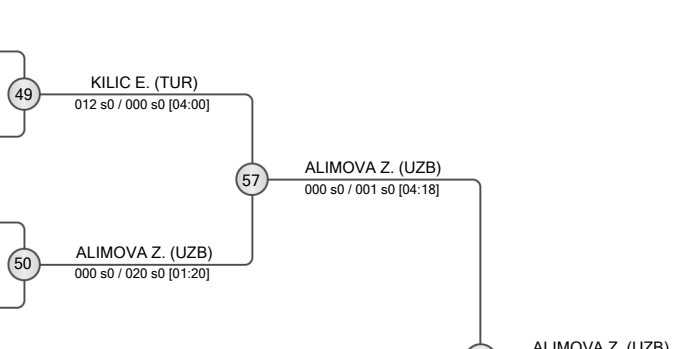

POOL B

CEPELAKOVA Lucie	CZE
PORCARI Miryam	ITA
BACKLUND Nova	SWE
NEUMANN Raphael	ISR
STOEGMANN Isabella	AUT
PETIDENT Ambre	FRA
DRESSLER Lotta	GER
PULJIC Lucija	CRO
CHRISP Taylor	GBR
BRAZINSKAITE Ieva	LTU
ALONSO FERNANDEZ Sara	ESP
RUSU Maria	MDA
KRONENTHAL Charlotte	GER
VALIZADA Sama	AZE

9	CEPELAKOVA L. (CZE)	37	CEPELAKOVA L. (CZE)
10	PORCARI M. (ITA)	38	PETIDENT A. (FRA)
11	NEUMANN R. (ISR)	39	PULJIC L. (CRO)
12	PETIDENT A. (FRA)	40	KRONENTHAL C. (GER)
13	PULJIC L. (CRO)		
14	BRAZINSKAITE I. (LTU)		
15	ALONSO FERNANDEZ S. (ESP)		
16	KRONENTHAL C. (GER)		

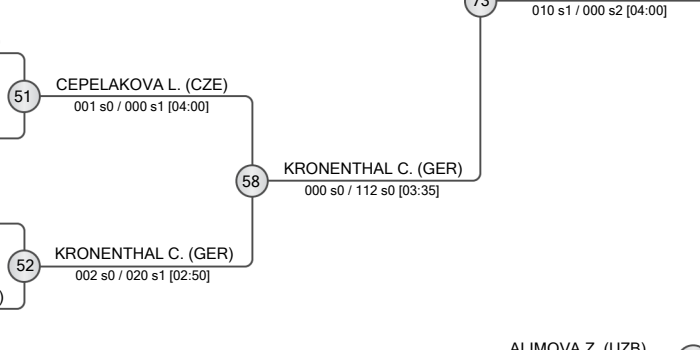

POOL C

KHAZRATOVA Gulsanam	UZB
TOPCU Ezgi	TUR
HAYUN Romy	ISR
SAS-ZALOZIECKI Valerie	AUT
OUWERKERK Shayen	NED
DANISOVA Ema	SVK
BRIAND Lea	GER
MEKAITON Shira	ISR
GUERRERO PADIN Ines	ESP
MAMMADTAGHIYEVA Gulnaz	AZE
BAUER Sina Josefin	GER
ACTIS Margherita	ITA
NEBHUTH Sophia	GER
KERSYTE Airuna	LTU
MITCHELL Evie	GBR

17	KHAZRATOVA G. (UZB)	41	KHAZRATOVA G. (UZB)
18	TOPCU E. (TUR)	42	OUWERKERK S. (NED)
19	OUWERKERK S. (NED)	43	MEKAITON S. (ISR)
20	DANISOVA E. (SVK)	44	ACTIS M. (ITA)
21	MEKAITON S. (ISR)		
22	MAMMADTAGHIYEVA G. (AZE)		
23	ACTIS M. (ITA)		
24	MITCHELL E. (GBR)		

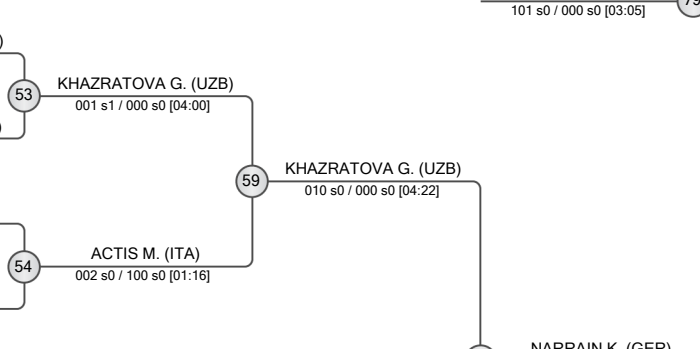

POOL D

CHERNOVA Carina	POR
MANECK Mia	GER
CAMERON Stella	GBR
ZINK Maxima	GER
LUOTO Eila	FIN
ABU JAHRUR Ines	BEL
BIXA Luzia	AUT
HASID Daniella	ISR
AHMADZADA Yaghmur	AZE
BELLEVAL Jaines	FRA
STAIU Patricia	ROU
GRUEVA Dara	BUL
NARRAIN Katharina	GER
TASCON MARTIN Minerva	ESP

25	CHERNOVA C. (POR)	45	CHERNOVA C. (POR)
26	MANECK M. (GER)	46	ZINK M. (GER)
27	CAMERON S. (GBR)	47	HASID D. (ISR)
28	ZINK M. (GER)	48	NARRAIN K. (GER)
29	HASID D. (ISR)		
30	BELLEVAL J. (FRA)		
31	GRUEVA D. (BUL)		
32	NARRAIN K. (GER)		

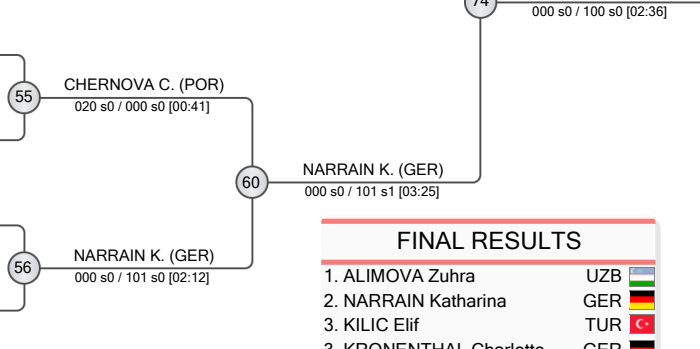

FINAL RESULTS

- ALIMOVA Zuhra (UZB)
- NARRAIN Katharina (GER)
- KILIC Elif (TUR)
- KRONENTHAL Charlotte (GER)
- KHAZRATOVA Gulsanam (UZB)
- CHERNOVA Carina (POR)
- CEPELAKOVA Lucie (CZE)
- OUWERKERK Shayen (NED)

REPECHAGE

BLANK E. (GER)	61	KILDEEVA D. (FIN)	65	KILDEEVA D. (FIN)
KILDEEVA D. (FIN)		BAECHLE S. (GER)	66	PULJIC L. (CRO)
VALIZADA S. (AZE)	62	ALONSO FERNANDEZ S. (ESP)	67	OUWERKERK S. (NED)
ALONSO FERNANDEZ S. (ESP)		TOPCU E. (TUR)	68	HASID D. (ISR)
TOPCU E. (TUR)	63	TASCON MARTIN M. (ESP)	69	KILIC E. (TUR)
TASCON MARTIN M. (ESP)		GRUEVA D. (BUL)	70	CEPELAKOVA L. (CZE)
GRUEVA D. (BUL)	64	HASID D. (ISR)	71	OUWERKERK S. (NED)
		CHERNOVA C. (POR)	72	CHERNOVA C. (POR)

61	KILDEEVA D. (FIN)	65	KILDEEVA D. (FIN)
62	ALONSO FERNANDEZ S. (ESP)	66	PULJIC L. (CRO)
63	TOPCU E. (TUR)	67	OUWERKERK S. (NED)
64	GRUEVA D. (BUL)	68	HASID D. (ISR)
65	KILDEEVA D. (FIN)	69	KILIC E. (TUR)
66	PULJIC L. (CRO)	70	CEPELAKOVA L. (CZE)
67	OUWERKERK S. (NED)	71	OUWERKERK S. (NED)
68	HASID D. (ISR)	72	CHERNOVA C. (POR)

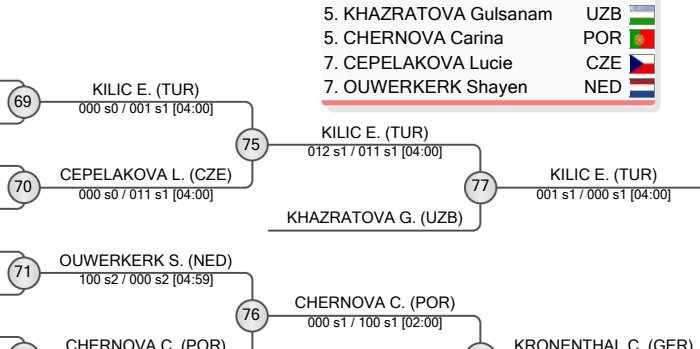



Berlin Millennium Team Cadet European Cup 2026

Germany, Berlin, 25-26 Apr 2026

-63 kg

Women (48)

POOL A

	BILEN Sevim Margaret	TUR
	KUTKEVICA Sofija	LAT
	SMITH Kayla	GBR
	VAN SON Frederique	NED
	LUEDTKE Lea Sophie	GER
	ROITBERG Emma	ITA
	VON LUTZ Sophia	AUT
	CALDEIRA Matilde	POR
	GONZALEZ ROMANILLOS Leyre	ESP
	CHIRILA Annalisa Nicole	ROU
	VALIYEVA Nazakat	AZE
	GRAFE Lene	GER

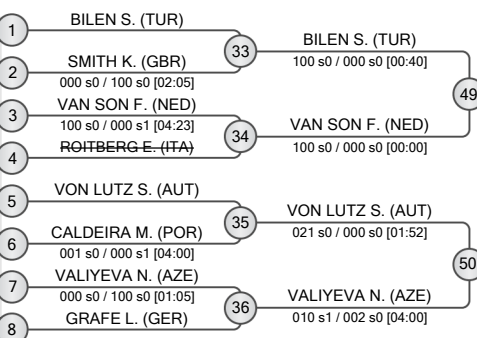

POOL B

	YILMAZ Duru	TUR
	BARONI Chiara	SUI
	GARCIA MONTES Judith Eloisa	ESP
	ROEMMER Amelie	GER
	LE TOUZE Lou	FRA
	KULIKAUSKAITE Meida	LTU
	STOEVA Andrea	BUL
	MUSAZZI Asia	ITA
	SHADI Gaida	AUT
	STOCK Luisa	GER
	KADYRKULOVA Medina	KGZ
	KROL Adel	ISR

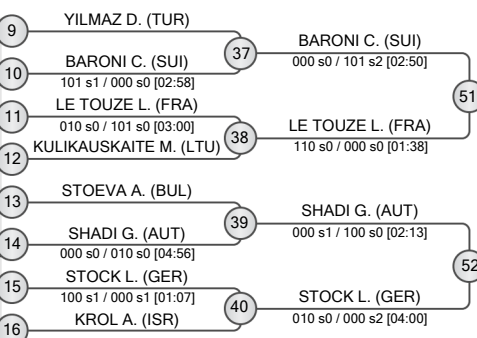

POOL C

	MASHURENKO Arina	UKR
	MATOUSKOVA Valentyna	CZE
	RODRIGUEZ SAENZ Ines	ESP
	BUETTNER Antonia	GER
	VASCO Ines	POR
	TREMBATCH Anna	FRA
	GLIGA Ana	ROU
	KAIN Kiara	AUT
	KOHLMANNLEHNER Nadja Alexandra	GER
	HUSEYNLI Zilan	AZE
	ZYGOMALA Ilektra	GRE
	BALYKIN Eden	ISR

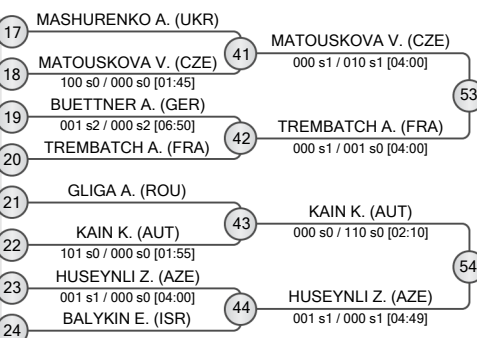

POOL D

	RAMA Bleona	AUT
	BJORK DALBERG Lova	SWE
	ZAHHAROVA Anastasia	EST
	GUENTHER Salima	GER
	ZHARASHUEVA Hanifa	BEL
	CRISOSTOMO Joana Filipa	POR
	KYIALBEKOVA Aaisha	KGZ
	STRUJIK Jayda	NED
	MAMMADLI Turkan	AZE
	BESTAV Selin	TUR
	GIORDANO Valeria	ITA
	VOLK Latika	GER

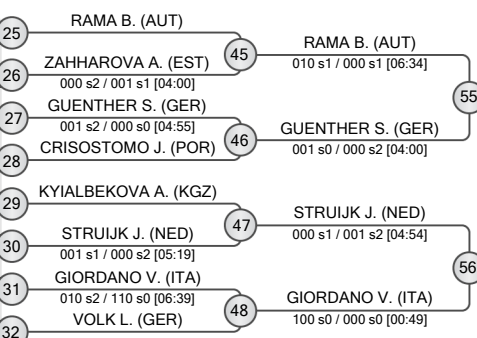

REPECHAGE

SMITH K. (GBR)	61	SMITH K. (GBR)
ROEMMER A. (GER)	62	ROEMMER A. (GER)
KULIKAUSKAITE M. (LTU)	63	MASHURENKO A. (UKR)
RODRIGUEZ SAENZ I. (ESP)	64	BESTAV S. (TUR)
MASHURENKO A. (UKR)	65	VAN SON F. (NED)
BESTAV S. (TUR)	66	ROEMMER A. (GER)
VOLK L. (GER)	67	STRUIJK J. (NED)
	68	RAMA B. (AUT)

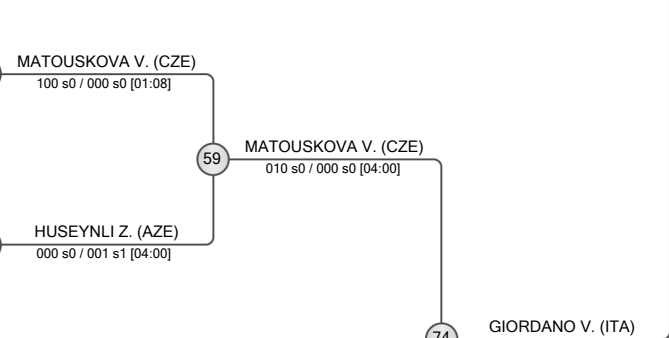
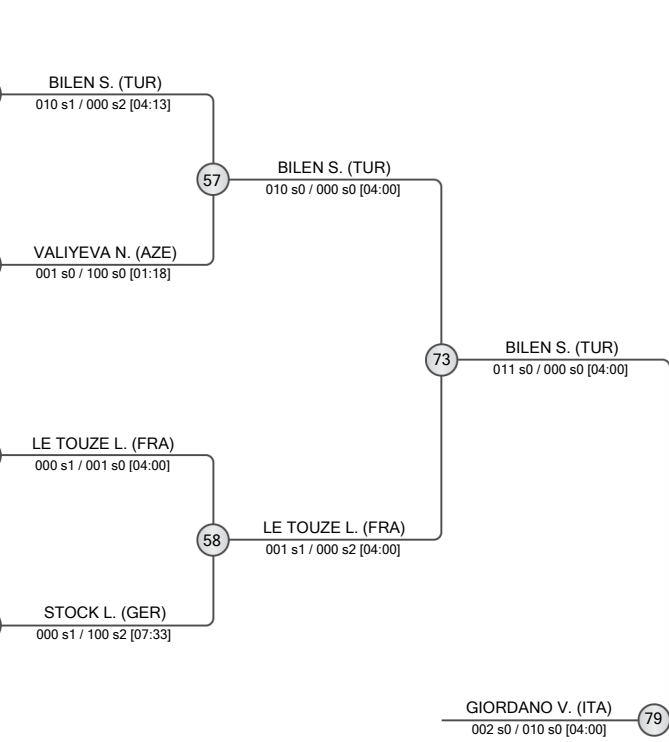
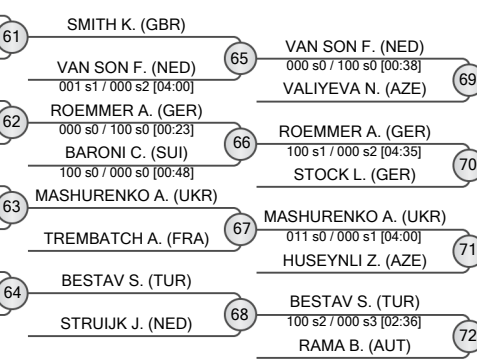

FINAL RESULTS		
1.	GIORDANO Valeria	ITA
2.	BILEN Sevim Margaret	TUR
3.	MATOUSKOVA Valentyna	CZE
3.	RAMA Bleona	AUT
5.	VAN SON Frederique	NED
5.	LE TOUZE Lou	FRA
7.	STOCK Luisa	GER
7.	HUSEYNLI Zilan	AZE





Berlin Millennium Team Cadet European Cup 2026

Germany, Berlin, 25-26 Apr 2026

-70 kg

Women (33)

POOL A

1	WOEGERER Selina (AUT)	WOEGERER S. (AUT)
2	DAVIES Robyn (GBR)	DAVIES R. (GBR)
3	KARATAS Busra (TUR)	KARATAS B. (TUR)
4	PILZ Amelie Fabienne (GER)	PILZ A. (GER)
5	VENDRIG Esmee (NED)	VENDRIG E. (NED)
6	LEANZA Dorina (BEL)	LEANZA D. (BEL)
7	MALCZAK Lara Katharina (GER)	MALCZAK L. (GER)
8	MBENGUE RUANO Deguene Aisha (ESP)	MBENGUE RUANO D. (ESP)

POOL B

9	FILZWIESER Emma (AUT)	FILZWIESER E. (AUT)
10	KUCEROVA Anna (CZE)	KUCEROVA A. (CZE)
11	PAPAIIOANNOU Maria Eleni (GRE)	PAPAIIOANNOU M. (GRE)
12	KOCNIK Mia Juno (GER)	KOCNIK M. (GER)
13	MAMMADLI Masuma (AZE)	MAMMADLI M. (AZE)
14	MEGLAJ Erika (CRO)	MEGLAJ E. (CRO)
15	GOSSET Norah (FRA)	GOSSET N. (FRA)
16	WIKENE Ingrid (NOR)	WIKENE I. (NOR)

POOL C

17	KARAFFOVA Vanessa (CZE)	KARAFFOVA V. (CZE)
18	AHMADOVA Rena (AZE)	AHMADOVA R. (AZE)
19	GIL LEITAO Madalena (POR)	GIL LEITAO M. (POR)
20	KEDING Svenja (GER)	KEDING S. (GER)
21	OZBUDAK Done Melike (TUR)	OZBUDAK D. (TUR)
22	ZSCHIESCHE Frieda Hanni (GER)	ZSCHIESCHE F. (GER)
23	AUBRY Omairaa (FRA)	AUBRY O. (FRA)
24	ZAPOROJANU Sofia (MDA)	ZAPOROJANU S. (MDA)

POOL D

25	HUDIKA Vita (CRO)	HUDIKA V. (CRO)
26	ZUIDWIJK Noel (NED)	ZUIDWIJK N. (NED)
27	LATKOWSKI Antonia (GER)	LATKOWSKI A. (GER)
28	RABL Nia (AUT)	RABL N. (AUT)
29	FARAUANU Iasmina (ROU)	FARAUANU I. (ROU)
30	ZELL Amit (ISR)	ZELL A. (ISR)
31	THIERY Emilie (GER)	THIERY E. (GER)
32	GALBRAITH Zoe (GBR)	GALBRAITH Z. (GBR)
33	JUMABAEVA Poshshajon (UZB)	JUMABAEVA P. (UZB)

REPECHAGE

61	KARATAS B. (TUR)	WOEGERER S. (AUT)
62	WIKENE I. (NOR)	MAMMADLI M. (AZE)
63	ZSCHIESCHE F. (GER)	AUBRY O. (FRA)
64	GALBRAITH Z. (GBR)	ZELL A. (ISR)
65	WOEGERER S. (AUT)	VENDRIG E. (NED)
66	MAMMADLI M. (AZE)	KUCEROVA A. (CZE)
67	AUBRY O. (FRA)	KARAFFOVA V. (CZE)
68	ZELL A. (ISR)	ZUIDWIJK N. (NED)
69	WOEGERER S. (AUT)	WOEGERER S. (AUT)
70	KUCEROVA A. (CZE)	KUCEROVA A. (CZE)
71	KARAFFOVA V. (CZE)	KARAFFOVA V. (CZE)
72	ZUIDWIJK N. (NED)	ZUIDWIJK N. (NED)

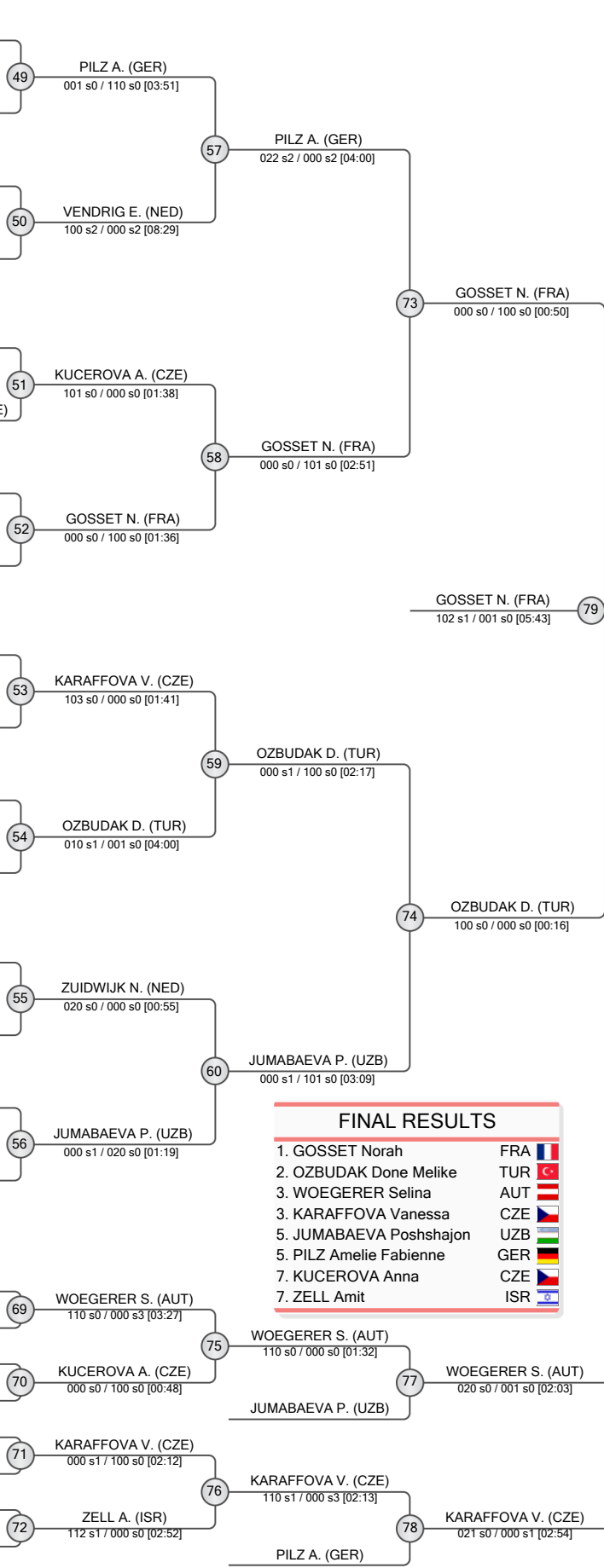

FINAL RESULTS		
1.	GOSSET Norah	FRA
2.	OZBUDAK Done Melike	TUR
3.	WOEGERER Selina	AUT
4.	KARAFFOVA Vanessa	CZE
5.	JUMABAEVA Poshshajon	UZB
6.	PILZ Amelie Fabienne	GER
7.	KUCEROVA Anna	CZE
8.	ZELL Amit	ISR





Berlin Millennium Team Cadet European Cup 2026

Germany, Berlin, 25-26 Apr 2026

+ 70 kg

Women (16)

POOL A

	BALCI Hatice Tuana	TUR
	WANDJI Maelyne	FRA
	VAN DRIEL Nova	NED
	BARNEKOW Lena Sophie	GER

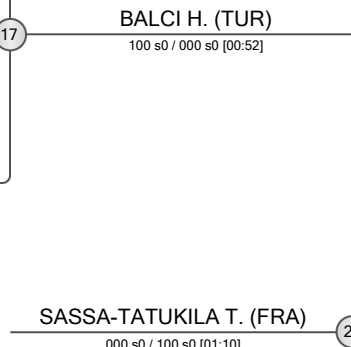
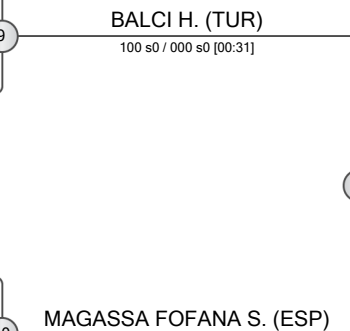
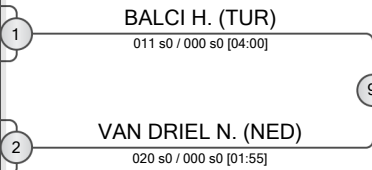

POOL B

	PALERMO Elisa	ITA
	MOROU Hidaya	GER
	MAGASSA FOFANA Sogona	ESP
	VAN SUNDERT Fleur	NED

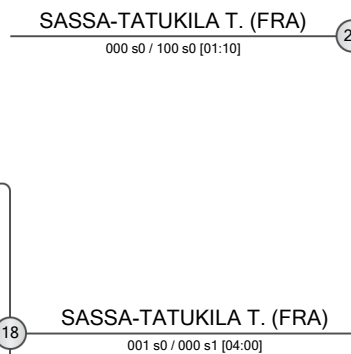
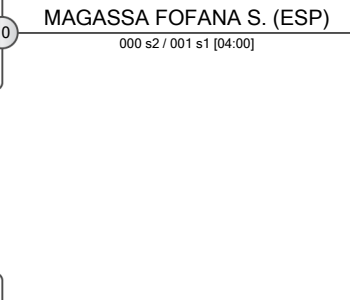
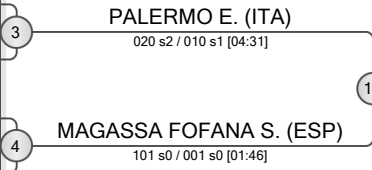

POOL C

	COULIBALY TOURE Ballalo	ESP
	DECKER Meerit	GER
	SASSA-TATUKILA Therese-Grace	FRA
	HERMANS Tess	NED

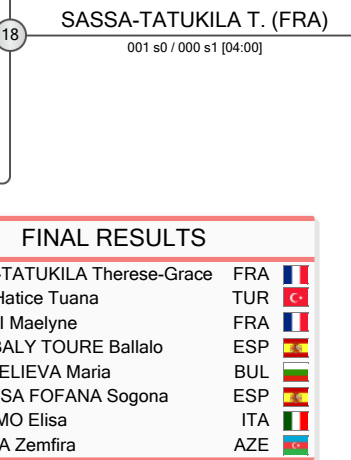
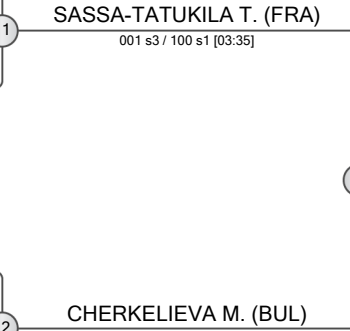
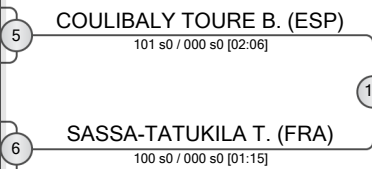

POOL D

	CHERKELIEVA Maria	BUL
	CONRAD Lucia	DEN
	ALIYEVA Zemfira	AZE
	BUSCHMANN Elisabeth	GER

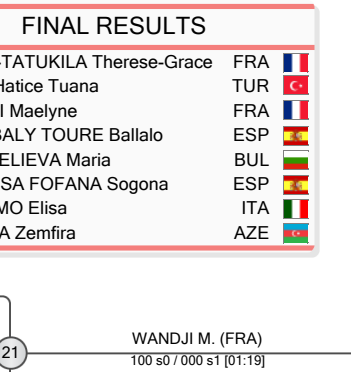
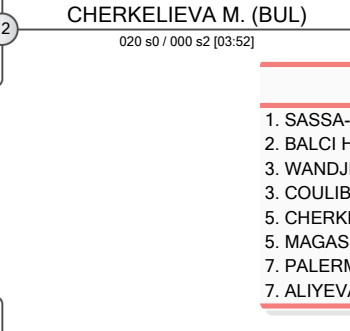
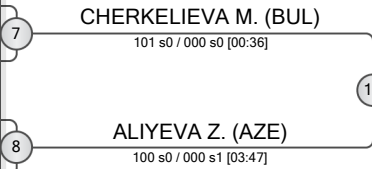

REPECHAGE

WANDJI M. (FRA)	13
VAN DRIEL N. (NED)	14
VAN SUNDERT F. (NED)	15
PALERMO E. (ITA)	16
HERMANS T. (NED)	17
COULIBALY TOURE B. (ESP)	18
CONRAD L. (DEN)	19
ALIYEVA Z. (AZE)	20

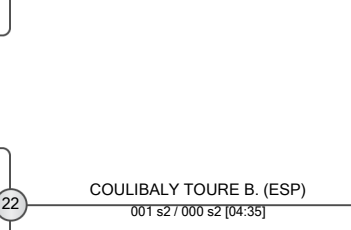
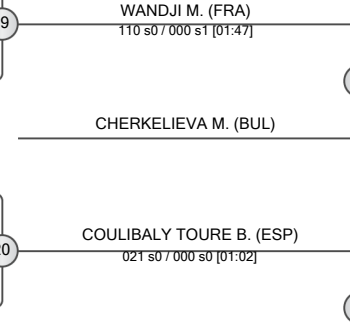
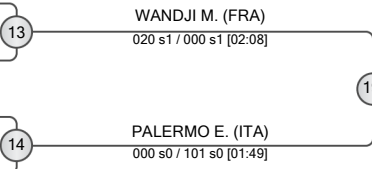

FINAL RESULTS		
1.	SASSA-TATUKILA Therese-Grace	FRA
2.	BALCI Hatice Tuana	TUR
3.	WANDJI Maelyne	FRA
3.	COULIBALY TOURE Ballalo	ESP
5.	CHERKELIEVA Maria	BUL
5.	MAGASSA FOFANA Sogona	ESP
7.	PALERMO Elisa	ITA
7.	ALIYEVA Zemfira	AZE

