



Bielsko Biala Millennium Team Cadet European Cup 2026

Poland, Bielsko Biala, 16-17 May 2026

-50 kg

Men (42)

POOL A

KUDAIBERGEN Bekarys KAZ	1	KUDAIBERGEN B. (KAZ)		
MARKOVICS Adam SVK	2	MARKOVICS A. (SVK)	33	MARKOVICS A. (SVK) 000 s0 / 001 s2 [06:01]
GUMNY Jędrzej POL	3	POELSTRA F. (NED)		
POELSTRA Ferron NED			34	POELSTRA F. (NED) 000 s1 / 001 s1 [04:00]
KABLAR Vidak SRB	4	KABLAR V. (SRB)		
SEMENENKO Zoreslav UKR	5	SEMENENKO Z. (UKR)		
TUDOR Alin ROU	6	STOLAKIS M. (GER)	35	SEMENENKO Z. (UKR) 010 s2 / 001 s1 [04:00]
STOLAKIS Mariano GER				
PALMAERTS Jolan BEL	7	PALMAERTS J. (BEL)		
LAHRIFI Moulay-Mountasir FRA	8	LAHRIFI M. (FRA)	36	LAHRIFI M. (FRA) 000 s3 / 100 s0 [01:38]

POOL B

AGHAYEV Nihad AZE	9	AGHAYEV N. (AZE)		
GAFFARLI Ali GER	10	GAFFARLI A. (GER)	37	AGHAYEV N. (AZE) 110 s0 / 000 s0 [03:18]
CHIUUA Samir BEL				
DOBROVOLSIS Mantas LTU	11	DOBROVOLSIS M. (LTU)		
TANASI Sando LAT			38	DOBROVOLSIS M. (LTU) 100 s0 / 000 s0 [01:32]
SOUKUP Matyas CZE	12	SOUKUP M. (CZE)		
ARGİ Amit ISR	13	ARGİ A. (ISR)		
SERIKKALI Bakdaulet KAZ	14	SERIKKALI B. (KAZ)	39	SERIKKALI B. (KAZ) 000 s0 / 100 s0 [00:34]
YANKOWSKI Mark POL				
MELADZE Nika GEO	15	MELADZE N. (GEO)		
PIDKIPNYY Timur UKR	16	PIDKIPNYY T. (UKR)	40	MELADZE N. (GEO) 100 s1 / 000 s3 [03:56]

POOL C

RZAZADE Farid AZE	17	RZAZADE F. (AZE)		
SPYROPOULOS Vasileios GRE	18	BAROVIC M. (MNE)	41	RZAZADE F. (AZE) 020 s0 / 000 s0 [02:30]
BAROVIC Milan MNE				
MAMETJEV Roman GER	19	MAMETJEV R. (GER)		
KISIS Ricards LAT			42	TKACHENKO K. (UKR) 001 s0 / 020 s1 [03:26]
TKACHENKO Kiril UKR	20	TKACHENKO K. (UKR)		
HEIMANS Klaas NED	21	HEIMANS K. (NED)		
GEUNS Gust BEL	22	GEUNS G. (BEL)	43	HEIMANS K. (NED) 100 s0 / 000 s1 [03:50]
NOZADZE Saba GEO	23	NOZADZE S. (GEO)		
GAT MUALEM Hillel ISR			44	NOZADZE S. (GEO) 100 s0 / 000 s0 [00:32]
OSKA Daniel POL	24	OSKA D. (POL)		

POOL D

HOFFMANN Andrea FRA	25	HOFFMANN A. (FRA)		
KOZAK Matus SVK	26	KOZAK M. (SVK)	45	HOFFMANN A. (FRA) 002 s0 / 001 s0 [04:14]
PAK Albert POL	27	TOKHOSASHVILI M. (GEO)		
TOKHOSASHVILI Muslim GEO			46	TOKHOSASHVILI M. (GEO) 000 s1 / 100 s0 [01:38]
ANANKO Tymofii UKR	28	ANANKO T. (UKR)		
NURBEKEN Adilzhan KAZ	29	NURBEKEN A. (KAZ)		
ZHALINSKYI Samir POL			47	NURBEKEN A. (KAZ) 101 s0 / 000 s0 [00:27]
RADIVOJEVIC Pavle SRB	30	RADIVOJEVIC P. (SRB)		
NAGY Levente HUN	31	NAGY L. (HUN)		
DEWULF Lorn BEL	32	DEWULF L. (BEL)	48	NURBEKEN A. (KAZ) 100 s0 / 000 s0 [01:26]

REPECHAGE

PALMAERTS J. (BEL)	61	PALMAERTS J. (BEL)		
YANKOWSKI M. (POL)		SEMENENKO Z. (UKR)	65	SEMENENKO Z. (UKR) 001 s0 / 100 s0 [01:11]
ARGİ A. (ISR)	62	ARGİ A. (ISR)		
GAT MUALEM H. (ISR)		MELADZE N. (GEO)	66	MARKOVICS A. (SVK) 100 s0 / 000 s0 [01:38]
OSKA D. (POL)		OSKA D. (POL)		
OSKA D. (POL)	63	OSKA D. (POL)		
KOZAK M. (SVK)	64	HEIMANS K. (NED)	67	AGHAYEV N. (AZE) 000 s2 / 002 s1 [04:00]
		HEIMANS K. (NED)		
		KOZAK M. (SVK)	68	RZAZADE F. (AZE) 000 s3 / 100 s2 [09:56]
		TOKHOSASHVILI M. (GEO)		
		NURBEKEN A. (KAZ)	72	NURBEKEN A. (KAZ) 000 s3 / 100 s1 [11:49]
		NURBEKEN A. (KAZ)		

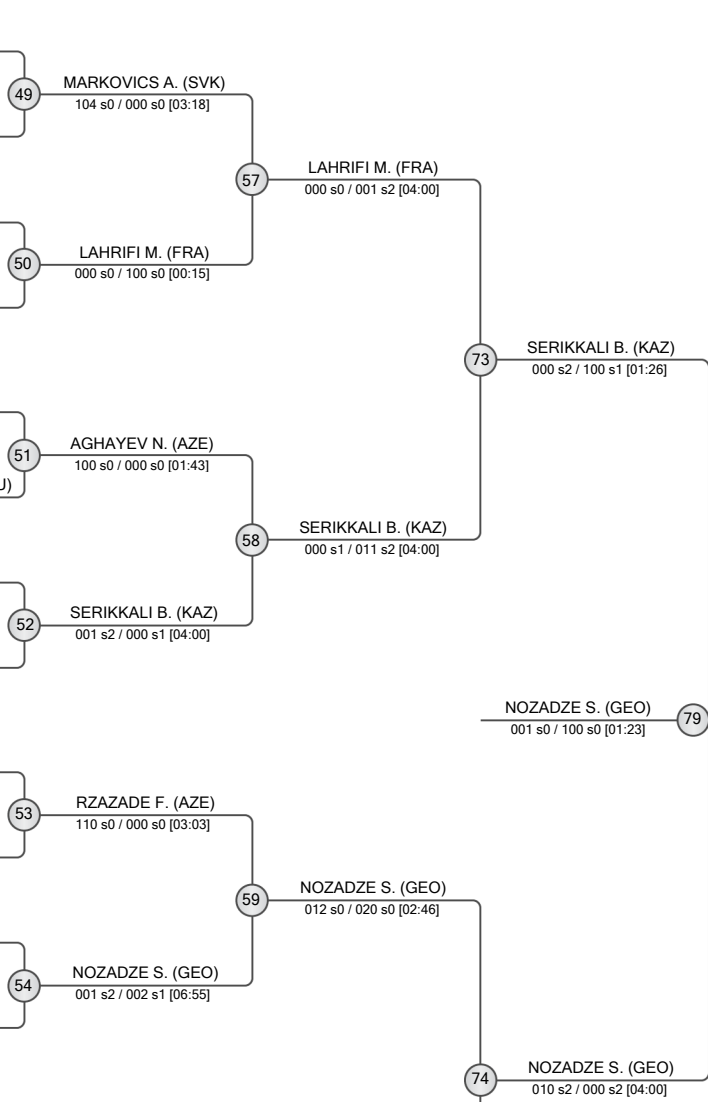

FINAL RESULTS		
1. NOZADZE Saba	GEO	
2. SERIKKALI Bakdaulet	KAZ	
3. AGHAYEV Nihad	AZE	
3. NURBEKEN Adilzhan	KAZ	
5. HOFFMANN Andrea	FRA	
7. LAHRIFI Moulay-Mountasir	FRA	
7. SEMENENKO Zoreslav	UKR	
7. RZAZADE Farid	AZE	





Bielsko Biala Millennium Team Cadet European Cup 2026

Poland, Bielsko Biala, 16-17 May 2026

-55 kg

Men (50)

POOL A

UYAR Celil (NED)	1	UYAR C. (NED)	33	UYAR C. (NED)	49
SORAJIC Matija (BIH)	2	BARAK D. (GER)	000 s1 / 112 s0 [02:23]	100 s0 / 000 s0 [00:37]	
BARAK Davor (GER)	3	SILEN T. (FIN)	101 s1 / 000 s2 [03:50]	GAZIZOV R. (KAZ)	57
SILEN Topi (FIN)	4	GAZIZOV R. (KAZ)	001 s1 / 020 s0 [01:48]	000 s0 / 020 s1 [03:36]	
KUJAWA Marco (POL)	5	AVRAMOVIC B. (SRB)		GAZIZOV R. (KAZ)	73
GAZIZOV Rauan (KAZ)	6	BACK J. (FRA)	010 s0 / 000 s1 [04:00]	111 s0 / 000 s1 [02:56]	
AVRAMOVIC Boban (SRB)	7	GAFFARLI A. (GER)	000 s0 / 100 s0 [00:41]	001 s2 / 000 s1 [06:22]	
BACK Jules (FRA)	8	ROVENSKY M. (SVK)	100 s0 / 000 s0 [02:56]	AVRAMOVIC B. (SRB)	50
MICIULEVICIUS Gustas (LTU)				001 s2 / 000 s1 [06:22]	
BAKOWICZ Dawid (POL)					
GAFFARLI Al-Hasan (GER)					
ROVENSKY Martin (SVK)					

POOL B

KHUDIYEV Farid (AZE)	9	KHUDIYEV F. (AZE)	37	KHUDIYEV F. (AZE)	51
VLAD Sorin (ROU)	10	VLAD S. (ROU)	020 s0 / 000 s0 [02:29]	100 s0 / 000 s0 [01:39]	
LYTVYENENKO Yehor (UKR)	11	BAUER E. (GER)	100 s0 / 000 s0 [00:00]	MICIULEVICIUS G. (LTU)	58
BAUER Eddie (GER)	12	MICIULEVICIUS G. (LTU)	000 s1 / 011 s2 [04:00]	100 s2 / 000 s3 [08:07]	
KRYSZOSIAK Juliusz (POL)	13	TALIBOV I. (AZE)		TALIBOV I. (AZE)	79
MICIULEVICIUS Gilius (LTU)	14	JAKL M. (CZE)	000 s0 / 100 s0 [00:00]	000 H / 100 s0 [03:14]	
TALIBOV Ibrahim (AZE)	15	PANDAY D. (NED)	000 s0 / 100 s0 [04:47]	TALIBOV I. (AZE)	52
KRNETA Branko (BIH)	16	SHVARTS A. (ISR)	100 s0 / 000 s1 [01:10]	100 s0 / 000 s3 [04:17]	
JAKL Marek (CZE)					
KOPIEC Piotr (POL)					
PANDAY Diego (NED)					
SHVARTS Amit (ISR)					
RUSU Andrei (MDA)					

POOL C

DOBROWOLSKI Bartlomiej (POL)	17	DOBROWOLSKI B. (POL)	41	DOBROWOLSKI B. (POL)	53
FILIP Artiom (MDA)	18	RATKOVIC U. (BIH)	000 s1 / 011 s1 [04:00]	100 s0 / 000 s0 [00:57]	
RATKOVIC Uros (BIH)	19	MANSUR X. (NED)	000 s0 / 020 s0 [02:54]	MANSUR X. (NED)	59
ANDJELOVIC Ilija (SRB)	20	NAGY N. (HUN)	100 s0 / 000 s3 [07:01]	000 s1 / 001 s1 [07:16]	
MANSUR Xavio (NED)	21	KHALILLI R. (AZE)		KHALILLI R. (AZE)	74
NAGY Nimrod (HUN)	22	KOKKONEN V. (FIN)	000 s0 / 001 s2 [04:00]	000 s0 / 011 s0 [04:00]	
KHALILLI Rza (AZE)	23	CHANSSEAUME L. (FRA)	010 s0 / 000 s1 [04:27]	KHALILLI R. (AZE)	54
KOWALSKI Milosz (POL)	24	CIBULSKAS E. (LTU)	101 s0 / 000 s0 [01:23]	001 s1 / 000 s0 [06:08]	
KOKKONEN Valtteri (FIN)					
CHANSSEAUME Lucas (FRA)					
TANSINGCO Gabryl (GER)					
CIBULSKAS Einoras (LTU)					
SEFSAF Hamza (BEL)					

POOL D

SHREBERK Guy (ISR)	25	SHREBERK G. (ISR)	45	SHREBERK G. (ISR)	55
POPA Igor (MDA)	26	MAKSIMOWICZ F. (POL)	000 s0 / 020 s0 [01:03]	111 s0 / 000 s0 [01:40]	
MAKSIMOWICZ Fabian (POL)	27	ASPROIU G. (ROU)	001 s0 / 002 s1 [04:00]	GARVE S. (GER)	60
KART Ahmet (TUR)	28	GARVE S. (GER)	000 s1 / 001 s1 [04:00]	000 s0 / 010 s1 [04:00]	
ASPROIU George (ROU)	29	MARKOVIC P. (SRB)		IZBASSAR B. (KAZ)	77
GARVE Sou (GER)	30	IZBASSAR B. (KAZ)	000 s0 / 001 s1 [06:25]	000 s1 / 001 s0 [04:00]	
MARKOVIC Petar (SRB)	31	KREMER A. (GER)	000 s0 / 100 s0 [01:19]	IZBASSAR B. (KAZ)	56
SVIMONISHVILI Goga (GEO)	32	BENKROUIDEM N. (FRA)	000 s1 / 100 s0 [02:27]	100 s0 / 000 s0 [00:53]	
IZBASSAR Bakdaulet (KAZ)					
ALWAQEDI Hashem (POL)					
KREMER Arthur (GER)					
BENKROUIDEM Noham (FRA)					

FINAL RESULTS

- TALIBOV Ibrahim (AZE)
- IZBASSAR Bakdaulet (KAZ)
- KHALILLI Rza (AZE)
- GAZIZOV Rauan (KAZ)
- UYAR Celil (NED)
- MANSUR Xavio (NED)
- PANDAY Diego (NED)
- BENKROUIDEM Noham (FRA)

REPECHAGE

SILEN T. (FIN)	61	SILEN T. (FIN)	65	UYAR C. (NED)	69	UYAR C. (NED)	75	UYAR C. (NED)	77
JAKL M. (CZE)	62	JAKL M. (CZE)	66	PANDAY D. (NED)	70	PANDAY D. (NED)	76	KHALILLI R. (AZE)	78
KOKKONEN V. (FIN)	63	KOKKONEN V. (FIN)	67	CHANSSEAUME L. (FRA)	71	MANSUR X. (NED)	77	GAZIZOV R. (KAZ)	
SVIMONISHVILI G. (GEO)	64	SVIMONISHVILI G. (GEO)	68	BENKROUIDEM N. (FRA)	72	BENKROUIDEM N. (FRA)	78		
MARKOVIC P. (SRB)									





Bielsko Biala Millennium Team Cadet European Cup 2026

Poland, Bielsko Biala, 16-17 May 2026

-60 kg

Men (63)

POOL A

1	KELLY Kaiian (AUS)	33	SMERAK J. (CZE)
2	SMERAK Jiri (CZE)	101 s0 / 000 s0 [02:01]	001 s2 / 020 s1 [03:47]
3	SAMARTZIDIS Sergios (AUT)	34	SAMARTZIDIS S. (AUT)
4	BOULEMTAFES Shain (FRA)	010 s2 / 001 s2 [04:00]	010 s1 / 000 s2 [04:00]
5	NIKOLOV Antonio (BUL)	35	HUSIYEV M. (AZE)
6	HORBA Mykhailo (GER)	100 s0 / 000 s0 [00:29]	021 s0 / 000 s2 [03:51]
7	HUSIYEV Mahammadali (AZE)	36	KUROWSKI K. (POL)
8	WASIL David (IRL)	020 s0 / 000 s0 [01:23]	100 s0 / 100 s0 [00:15]
9	PAIS Maros (SVK)	002 s0 / 000 s0 [04:00]	100 s0 / 002 s1 [02:13]
10	CZINEGE David (HUN)	000 s0 / 100 s0 [00:15]	
11	TRUDOV David (MDA)		
12	KUROWSKI Krystian (POL)		
13	DABIC Pavle (BIH)		
14	BOLISAS Danielius (LTU)		

POOL B

9	BAUBEK Akhmet (KAZ)	37	BAUBEK A. (KAZ)	
10	LESKYS Juozas (LTU)	001 s0 / 000 s0 [04:00]	001 s0 / 000 s2 [04:31]	
11	SFARLEA Andrei (ROU)	000 s1 / 001 s1 [04:00]	51	BAUBEK A. (KAZ)
12	PARIPOVIC Andrija (CRO)	000 s1 / 001 s1 [04:00]	003 s0 / 000 s2 [04:00]	
13	CERVINSKIS Bogdanas (LAT)	38	CERVINSKIS B. (LAT)	
14	KUCHNA Dominik (POL)	020 s1 / 000 s2 [02:51]	101 s2 / 000 s0 [04:00]	
15	CAVALJI Serzhei (CZE)	001 s0 / 100 s0 [00:55]	52	DUBROVSKY T. (ISR)
16	KIS Botond (HUN)	000 s0 / 101 s0 [01:55]	101 s0 / 000 s0 [00:50]	
17	DUBROVSKY Tom (ISR)	020 s1 / 000 s1 [02:06]	39	DUBROVSKY T. (ISR)
18	LACIKA Silvio (SVK)	000 s0 / 101 s0 [01:55]	40	CABECANA P. (GER)
19	POTRATZ Konrad (POL)	000 s0 / 101 s0 [02:48]	40	CABECANA P. (GER)
20	ESENAM Leonidas (SUI)	000 s0 / 100 s1 [01:44]		
21	TALLEDO Gabriel (AUS)			
22	ASIRLI Bilal Efe (TUR)			
23	SETROREDJO Levy (NED)			
24	CABECANA Phil (GER)			

POOL C

17	TERAN VELAZQUEZ Ricardo Manuel (MEX)	41	MEZHIEV R. (GER)	
18	MEZHIEV Rasul (GER)	000 s0 / 101 s1 [03:45]	100 s0 / 000 s0 [00:17]	
19	FRANKLIN Chayse (GBR)	100 s0 / 000 s0 [01:35]	53	MEZHIEV R. (GER)
20	NIKOLIC Teodor Luka (SRB)	010 s1 / 000 s0 [04:00]	42	KISS C. (HUN)
21	KISS Csongor (HUN)	100 s1 / 000 s1 [02:58]	100 s1 / 000 s0 [02:41]	
22	JURAS Filip (POL)	000 s2 / 001 s1 [04:00]	54	AMANGELDY B. (KAZ)
23	GOLUBOVSKIJ Liutauras (LTU)	000 s2 / 001 s1 [04:00]	43	AMANGELDY B. (KAZ)
24	TURCAN Cristian (MDA)	000 s2 / 010 s1 [04:00]	44	ANDREEV N. (AUT)
25	GUR Ramazan Aykut (TUR)	001 s0 / 011 s1 [04:29]	44	ANDREEV N. (AUT)
26	GLENSKI Jakub (POL)	100 s0 / 000 s0 [02:06]		
27	LAZAR Matus (SVK)	012 s0 / 002 s1 [04:14]		
28	AMANGELDY Beknur (KAZ)			
29	GONZALEZ Loris (FRA)			
30	ANDREEV Nikita (AUT)			
31	SMIT Olivier (NED)			
32	SPYCHALA Michal (POL)			

POOL D

25	CHOI Isaac (AUS)	45	ASGAROV M. (AZE)	
26	SARNOWSKI Mikolaj (POL)	000 s2 / 010 s1 [05:19]	000 s3 / 100 s1 [04:19]	
27	LAZAREVIC Lazar (BIH)	000 s0 / 100 s0 [00:16]	55	ASGAROV M. (AZE)
28	ASGAROV Mehman (AZE)	000 s0 / 100 s0 [00:16]	011 s2 / 000 s1 [04:00]	
29	PETSCHALLIES Noah (GER)	46	EBNETER R. (SUI)	
30	EBNETER Ramon (SUI)	000 s3 / 100 s1 [05:05]	001 s1 / 000 s2 [06:59]	
31	TOROK Zoltan (HUN)	47	GABIT R. (KAZ)	
32	RACKAUSKAS Ignas (LTU)	100 s1 / 000 s3 [02:53]	101 s0 / 000 s0 [01:01]	
33	GABIT Rassulkhan (KAZ)	48	RUCINSKI-ZAJAC A. (POL)	
34	TURCHYN Matviei (UKR)	020 s0 / 000 s1 [02:25]	000 s0 / 001 s1 [04:00]	
35	SCHUMANN Janek Paul (GER)	000 s1 / 001 s0 [04:00]		
36	HRNIC Marin (CRO)			
37	NOGUEIRA DA SILVA Tomas (AND)			
38	FOSER Nik (LIE)			
39	KATS Matvii (CZE)			
40	RUCINSKI-ZAJAC Antoni (POL)			

REPECHAGE

61	WASIL D. (IRL)	65	KUROWSKI K. (POL)
62	PAIS M. (SVK)	001 s0 / 020 s0 [02:11]	000 s1 / 020 s1 [03:30]
63	LACIKA S. (SVK)	66	CABECANA P. (GER)
64	ESENAM L. (SUI)	000 s0 / 020 s1 [02:15]	000 s0 / 001 s2 [04:00]
65	LAZAR M. (SVK)	67	GUR R. (TUR)
66	GUR R. (TUR)	020 s0 / 000 s0 [00:21]	021 s0 / 000 s0 [02:48]
67	TURCHYN M. (UKR)	68	ASGAROV M. (AZE)
68	SCHUMANN J. (GER)	000 s2 / 110 s0 [03:12]	001 s1 / 020 s0 [02:08]
69	ASGAROV M. (AZE)		
70	HUSIYEV M. (AZE)		
71	BAUBEK A. (KAZ)		
72	AMANGELDY B. (KAZ)		
73	DUBROVSKY T. (ISR)		
74	GABIT R. (KAZ)		
75	MEZHIEV R. (GER)		
76	ASGAROV M. (AZE)		
77	BAUBEK A. (KAZ)		
78	ASGAROV M. (AZE)		
79	GABIT R. (KAZ)		

FINAL RESULTS

- GABIT Rassulkhan (KAZ)
- DUBROVSKY Tom (ISR)
- BAUBEK Akhmet (KAZ)
- ASGAROV Mehman (AZE)
- AMANGELDY Beknur (KAZ)
- HUSIYEV Mahammadali (AZE)
- SAMARTZIDIS Sergios (AUT)
- GUR Ramazan Aykut (TUR)



Bielsko Biala Millennium Team Cadet European Cup 2026

Poland, Bielsko Biala, 16-17 May 2026

-66 kg

Men (81)

POOL A

ISR	SIMKHAEV Tom	1	SIMKHAEV T. (ISR)
POL	STRASZAK Mateusz	2	SHYKULA D. (UKR)
UKR	SHYKULA Daniel	3	ANTIC A. (SRB)
AZE	ALAKBAROV Elgun	4	PANCZEL C. (HUN)
SRB	ANTIC Aleksa	5	DOBRAUZ L. (SUI)
HUN	PANCZEL Csanad	6	GABAYEV Y. (BEL)
SUI	DOBRAUZ Leonard	7	FRATILA P. (ROU)
BEL	GABAYEV Yacine	8	FRICK Lennox
ROU	FRATILA Paul Dumitru	9	WITCZAK Cyprian
GER	FRICK Lennox	10	LAFORGE Yann
POL	WITCZAK Cyprian	11	STASIEWICZ Blazej
FRA	LAFORGE Yann	12	SVEC Hynek
POL	STASIEWICZ Blazej	13	CRISTIAN P. (AND)
CZE	SVEC Hynek	14	SEFFER M. (SVK)
AND	CRISTIAN P. (AND)	15	VEJINIS A. (LTU)
SVK	SEFFER Matus	16	VEJINIS Arminas
POL	SLYCHAN Mateusz	17	CRETU D. (MDA)
LTU	VEJINIS Arminas	18	CRETU D. (MDA)
MDA	CRETU Dorin	19	HORODIUK M. (UKR)
UKR	HORODIUK Matvii	20	NGUEN K. (BUL)
BUL	NGUEN Kristiyan	21	WISNIEWSKI D. (POL)
POL	WISNIEWSKI Dawid	22	SAKALAUSKAS A. (LTU)
LTU	SAKALAUSKAS Adas	23	DZHABELOV I. (BEL)
ROU	KOKA Krisztian	24	DZHABELOV I. (BEL)
BEL	DZHABELOV Imran	25	RADANOV N. (SRB)
SRB	RADANOV Nikola	26	HACKSTEINER M. (AUT)
AUT	HACKSTEINER Michael	27	UHREKHELIDZE D. (UKR)
UKR	UHREKHELIDZE Davyd	28	UHREKHELIDZE D. (UKR)
UKR	UHREKHELIDZE Davyd	29	USSENOV Y. (KAZ)
KAZ	USSENOV Y. (KAZ)	30	USSENOV Y. (KAZ)
SVK	BRISUDA Filip	31	WILKOMIRSKI F. (POL)
POL	WILKOMIRSKI Filip	32	STOLBUN V. (UKR)
UKR	STOLBUN Viacheslav	33	SLAK L. (SLO)
SLO	SLAK Luka Dan	34	DRASKOVIC M. (BIH)
BIH	DRASKOVIC Milos	35	NEDELKOVICS Jr. David
HUN	NEDELKOVICS Jr. David	36	KULSHA A. (GER)
GER	KULSHA Artur	37	KULSHA A. (GER)
GER	KULSHA Artur	38	MALOTA M. (POL)
LTU	ZUBAVICIUS Tadas	39	MALOTA Michal
POL	MALOTA Michal	40	BALUNOVIC P. (CRO)
CRO	BALUNOVIC Petar	41	BALUNOVIC P. (CRO)
CRO	BALUNOVIC Petar	42	MANSOURI M. (FRA)
FRA	MANSOURI Malek	43	MANSOURI M. (FRA)
FRA	MANSOURI Malek	44	MANSOURI M. (FRA)
MDA	GORCEAC Oleg	45	GORCEAC O. (MDA)
MDA	GORCEAC Oleg	46	GORCEAC O. (MDA)

POOL B

POL	WISNIEWSKI Dawid	17	WISNIEWSKI D. (POL)
LTU	SAKALAUSKAS Adas	18	SAKALAUSKAS A. (LTU)
ROU	KOKA Krisztian	19	DZHABELOV I. (BEL)
BEL	DZHABELOV Imran	20	RADANOV N. (SRB)
SRB	RADANOV Nikola	21	HACKSTEINER M. (AUT)
AUT	HACKSTEINER Michael	22	UHREKHELIDZE D. (UKR)
UKR	UHREKHELIDZE Davyd	23	USSENOV Y. (KAZ)
KAZ	USSENOV Y. (KAZ)	24	USSENOV Y. (KAZ)
SVK	BRISUDA Filip	25	WILKOMIRSKI F. (POL)
POL	WILKOMIRSKI Filip	26	STOLBUN V. (UKR)
UKR	STOLBUN Viacheslav	27	SLAK L. (SLO)
SLO	SLAK Luka Dan	28	DRASKOVIC M. (BIH)
BIH	DRASKOVIC Milos	29	NEDELKOVICS Jr. David
HUN	NEDELKOVICS Jr. David	30	KULSHA A. (GER)
GER	KULSHA Artur	31	MALOTA M. (POL)
LTU	ZUBAVICIUS Tadas	32	MALOTA Michal
POL	MALOTA Michal	33	BALUNOVIC P. (CRO)
CRO	BALUNOVIC Petar	34	BALUNOVIC P. (CRO)
CRO	BALUNOVIC Petar	35	MANSOURI M. (FRA)
FRA	MANSOURI Malek	36	MANSOURI M. (FRA)
FRA	MANSOURI Malek	37	MANSOURI M. (FRA)
MDA	GORCEAC Oleg	38	GORCEAC O. (MDA)
MDA	GORCEAC Oleg	39	GORCEAC O. (MDA)

REPECHAGE

125	SHYKULA D. (UKR)	129	SHYKULA D. (UKR)	133	DOBRAUZ L. (SUI)	137	CRETU D. (MDA)
126	HACKSTEINER M. (AUT)	130	USSENOV Y. (KAZ)	134	USSENOV Y. (KAZ)	138	USSENOV Y. (KAZ)
127	WIENS D. (GER)	131	WIENS D. (GER)	135	WIENS D. (GER)	139	KAPANADZE G. (GEO)
128	MULYK D. (UKR)	132	MAKULAVICIUS R. (LTU)	136	BOLATBEK B. (KAZ)	140	RADOSEVIC O. (MNE)
129	PANCZEL C. (HUN)	133	DOBRAUZ L. (SUI)	137	CRETU D. (MDA)	141	SIMKHAEV T. (ISR)
130	USSENOV Y. (KAZ)	134	USSENOV Y. (KAZ)	138	USSENOV Y. (KAZ)	142	GARAYEV I. (AZE)
131	WIENS D. (GER)	132	MAKULAVICIUS R. (LTU)	136	BOLATBEK B. (KAZ)	143	TATARYN N. (UKR)
132	MULYK D. (UKR)	133	DOBRAUZ L. (SUI)	137	CRETU D. (MDA)	144	KAPANADZE G. (GEO)
133	DOBRAUZ L. (SUI)	134	USSENOV Y. (KAZ)	138	USSENOV Y. (KAZ)	145	TATARYN N. (UKR)
134	USSENOV Y. (KAZ)	135	WIENS D. (GER)	139	KAPANADZE G. (GEO)	146	KAPANADZE G. (GEO)
135	WIENS D. (GER)	136	BOLATBEK B. (KAZ)	140	RADOSEVIC O. (MNE)	147	SIMKHAEV T. (ISR)
136	BOLATBEK B. (KAZ)	137	CRETU D. (MDA)	141	SIMKHAEV T. (ISR)	148	GARAYEV I. (AZE)
137	CRETU D. (MDA)	138	USSENOV Y. (KAZ)	142	GARAYEV I. (AZE)	149	UHREKHELIDZE D. (UKR)
138	USSENOV Y. (KAZ)	139	KAPANADZE G. (GEO)	143	TATARYN N. (UKR)	150	UHREKHELIDZE D. (UKR)
139	KAPANADZE G. (GEO)	140	RADOSEVIC O. (MNE)	144	KAPANADZE G. (GEO)	151	UHREKHELIDZE D. (UKR)
140	RADOSEVIC O. (MNE)	141	SIMKHAEV T. (ISR)	145	TATARYN N. (UKR)	152	UHREKHELIDZE D. (UKR)
141	SIMKHAEV T. (ISR)	142	GARAYEV I. (AZE)	146	KAPANADZE G. (GEO)	153	UHREKHELIDZE D. (UKR)
142	GARAYEV I. (AZE)	143	TATARYN N. (UKR)	147	SIMKHAEV T. (ISR)	154	UHREKHELIDZE D. (UKR)
143	TATARYN N. (UKR)	144	KAPANADZE G. (GEO)	148	GARAYEV I. (AZE)	155	UHREKHELIDZE D. (UKR)
144	KAPANADZE G. (GEO)	145	TATARYN N. (UKR)	149	UHREKHELIDZE D. (UKR)	156	UHREKHELIDZE D. (UKR)
145	TATARYN N. (UKR)	146	KAPANADZE G. (GEO)	150	UHREKHELIDZE D. (UKR)	157	UHREKHELIDZE D. (UKR)
146	KAPANADZE G. (GEO)	147	SIMKHAEV T. (ISR)	151	UHREKHELIDZE D. (UKR)	158	UHREKHELIDZE D. (UKR)
147	SIMKHAEV T. (ISR)	148	GARAYEV I. (AZE)	152	UHREKHELIDZE D. (UKR)	159	UHREKHELIDZE D. (UKR)
148	GARAYEV I. (AZE)	149	UHREKHELIDZE D. (UKR)	153	UHREKHELIDZE D. (UKR)	160	UHREKHELIDZE D. (UKR)
149	UHREKHELIDZE D. (UKR)	150	UHREKHELIDZE D. (UKR)	154	UHREKHELIDZE D. (UKR)	161	UHREKHELIDZE D. (UKR)
150	UHREKHELIDZE D. (UKR)	151	UHREKHELIDZE D. (UKR)	155	UHREKHELIDZE D. (UKR)	162	UHREKHELIDZE D. (UKR)
151	UHREKHELIDZE D. (UKR)	152	UHREKHELIDZE D. (UKR)	156	UHREKHELIDZE D. (UKR)	163	UHREKHELIDZE D. (UKR)
152	UHREKHELIDZE D. (UKR)	153	UHREKHELIDZE D. (UKR)	157	UHREKHELIDZE D. (UKR)	164	UHREKHELIDZE D. (UKR)
153	UHREKHELIDZE D. (UKR)	154	UHREKHELIDZE D. (UKR)	158	UHREKHELIDZE D. (UKR)	165	UHREKHELIDZE D. (UKR)
154	UHREKHELIDZE D. (UKR)	155	UHREKHELIDZE D. (UKR)	159	UHREKHELIDZE D. (UKR)	166	UHREKHELIDZE D. (UKR)
155	UHREKHELIDZE D. (UKR)	156	UHREKHELIDZE D. (UKR)	160	UHREKHELIDZE D. (UKR)	167	UHREKHELIDZE D. (UKR)
156	UHREKHELIDZE D. (UKR)	157	UHREKHELIDZE D. (UKR)	161	UHREKHELIDZE D. (UKR)	168	UHREKHELIDZE D. (UKR)
157	UHREKHELIDZE D. (UKR)	158	UHREKHELIDZE D. (UKR)	162	UHREKHELIDZE D. (UKR)	169	UHREKHELIDZE D. (UKR)
158	UHREKHELIDZE D. (UKR)	159	UHREKHELIDZE D. (UKR)	163	UHREKHELIDZE D. (UKR)	170	UHREKHELIDZE D. (UKR)
159	UHREKHELIDZE D. (UKR)	160	UHREKHELIDZE D. (UKR)	164	UHREKHELIDZE D. (UKR)	171	UHREKHELIDZE D. (UKR)
160	UHREKHELIDZE D. (UKR)	161	UHREKHELIDZE D. (UKR)	165	UHREKHELIDZE D. (UKR)	172	UHREKHELIDZE D. (UKR)
161	UHREKHELIDZE D. (UKR)	162	UHREKHELIDZE D. (UKR)	166	UHREKHELIDZE D. (UKR)	173	UHREKHELIDZE D. (UKR)
162	UHREKHELIDZE D. (UKR)	163	UHREKHELIDZE D. (UKR)	167	UHREKHELIDZE D. (UKR)	174	UHREKHELIDZE D. (UKR)
163	UHREKHELIDZE D. (UKR)	164	UHREKHELIDZE D. (UKR)	168	UHREKHELIDZE D. (UKR)	175	UHREKHELIDZE D. (UKR)
164	UHREKHELIDZE D. (UKR)	165	UHREKHELIDZE D. (UKR)	169	UHREKHELIDZE D. (UKR)	176	UHREKHELIDZE D. (UKR)
165	UHREKHELIDZE D. (UKR)	166	UHREKHELIDZE D. (UKR)	170	UHREKHELIDZE D. (UKR)	177	UHREKHELIDZE D. (UKR)
166	UHREKHELIDZE D. (UKR)	167	UHREKHELIDZE D. (UKR)	171	UHREKHELIDZE D. (UKR)	178	UHREKHELIDZE D. (UKR)
167	UHREKHELIDZE D. (UKR)	168	UHREKHELIDZE D. (UKR)	172	UHREKHELIDZE D. (UKR)	179	UHREKHELIDZE D. (UKR)
168	UHREKHELIDZE D. (UKR)	169	UHREKHELIDZE D. (UKR)	173	UHREKHELIDZE D. (UKR)	180	UHREKHELIDZE D. (UKR)
169	UHREKHELIDZE D. (UKR)	170	UHREKHELIDZE D. (UKR)	174	UHREKHELIDZE D. (UKR)	181	UHREKHELIDZE D. (UKR)
170	UHREKHELIDZE D. (UKR)	171	UHREKHELIDZE D. (UKR)	175	UHREKHELIDZE D. (UKR)	182	UHREKHELIDZE D. (UKR)
171	UHREKHELIDZE D. (UKR)	172	UHREKHELIDZE D. (UKR)	176	UHREKHELIDZE D. (UKR)	183	UHREKHELIDZE D. (UKR)
172	UHREKHELIDZE D. (UKR)	173	UHREKHELIDZE D. (UKR)	177	UHREKHELIDZE D. (UKR)	184	UHREKHELIDZE D. (UKR)
173	UHREKHELIDZE D. (UKR)	174	UHREKHELIDZE D. (UKR)	178	UHREKHELIDZE D. (UKR)	185	UHREKHELIDZE D. (UKR)
174	UHREKHELIDZE D. (UKR)	175	UHREKHELIDZE D. (UKR)	179	UHREKHELIDZE D. (UKR)	186	UHREKHELIDZE D. (UKR)
175	UHREKHELIDZE D. (UKR)	176	UHREKHELIDZE D. (UKR)	180	UHREKHELIDZE D. (UKR)	187	UHREKHELIDZE D. (UKR)
176	UHREKHELIDZE D. (UKR)	177	UHREKHELIDZE D. (UKR)	181	UHREKHELIDZE D. (UKR)	188	UHREKHELIDZE D. (UKR)
177	UHREKHELIDZE D. (UKR)	178	UHREKHELIDZE D. (UKR)	182	UHREKHELIDZE D. (UKR)	189	UHREKHELIDZE D. (UKR)
178	UHREKHELIDZE D. (UKR)	179	UHREKHELIDZE D. (UKR)	183	UHREKHELIDZE D. (UKR)	190	UHREKHELIDZE D. (UKR)
179	UHREKHELIDZE D. (UKR)	180	UHREKHELIDZE D. (UKR)	184	UHREKHELIDZE D. (UKR)	191	UHREKHELIDZE D. (UKR)
180	UHREKHELIDZE D. (UKR)	181	UHREKHELIDZE D. (UKR)	185	UHREKHELIDZE D. (UKR)	192	UHREKHELIDZE D. (UKR)
181	UHREKHELIDZE D. (UKR)	182	UHREKHELIDZE D. (UKR)	186	UHREKHELIDZE D. (UKR)	193	UHREKHELIDZE D. (UKR)
182	UHREKHELIDZE D. (UKR)	183	UHREKHELIDZE D. (UKR)	187	UHREKHELIDZE D. (UKR)	194	UHREKHELIDZE D. (UKR)
183	UHREKHELIDZE D. (UKR)	184	UHREKHELIDZE D. (UKR)	188	UHREKHELIDZE D. (UKR)	195	UHREKHELIDZE D. (UKR)
184	UHREKHELIDZE D. (UKR)	185	UHREKHELIDZE D. (UKR)	189	UHREKHELIDZE D. (UKR)	196	UHREKHELIDZE D. (UKR)
185	UHREKHELIDZE D. (UKR)	186	UHREKHELIDZE D. (UKR)	190	UHREKHELIDZE D. (UKR)	197	UHREKHELIDZE D. (UKR)
186	UHREKHELIDZE D. (UKR)	187	UHREKHELIDZE D. (UKR)	191	UHREKHELIDZE D. (UKR)	198	UHREKHELIDZE D. (UKR)
187	UHREKHELIDZE D. (UKR)	188	UHREKHELIDZE D. (UKR)	192	UHREKHELIDZE D. (UKR)	199	UHREKHELIDZE D. (UKR)
188	UHREKHELIDZE D. (UKR)	189	UHREKHELIDZE D. (UKR)	193	UHREKHELIDZE D. (UKR)	200	UHREKHELIDZE D. (UKR)
189	UHREKHELIDZE D. (UKR)	190	UHREKHELIDZE D. (UKR)	194	UHREKHELIDZE D. (UKR)	201	UHREKHELIDZE D. (UKR)
190	UHREKHELIDZE D. (UKR)	191	UHREKHELIDZE D. (UKR)	195	UHREKHELIDZE D. (UKR)	202	UHREKHELIDZE D. (UKR)
191	UHREKHELIDZE D. (UKR)	192	UHREKHELIDZE D. (UKR)	196	UHREKHELIDZE D. (UKR)	203	UHREKHELIDZE D. (UKR)
192	UHREKHELIDZE D. (UKR)	193	UHREKHELIDZE D. (UKR)	197	UHREKHELIDZE D. (UKR)	204	UHREKHELIDZE D. (UKR)
193	UHREKHELIDZE D. (UKR)	194	UHREKHELIDZE D. (UKR)	198	UHREKHELIDZE D. (UKR)	205	UHREKHELIDZE D. (UKR)
194	UHREKHELIDZE D. (UKR)	195	UHREKHELIDZE D. (UKR)	199	UHREKHELIDZE D. (UKR)	206	UHREKHELIDZE D. (UKR)
195	UHREKHELIDZE D. (UKR)	196	UHREKHELIDZE D. (UKR)	200	UHREKHELIDZE D. (UKR)	207	UHREKHELIDZE D. (UKR)
196	UHREKHELIDZE D. (UKR)	197	UHREKHELIDZE D. (UKR)	201	UHREKHELIDZE D. (UKR)	208	UHREKHELIDZE D. (UKR)
197	UHREKHELIDZE D. (UKR)	198	UHREKHELIDZE D. (UKR)	202	UHREKHELIDZE D. (UKR)	209	UHREKHELIDZE D. (UKR)
198	UHREKHELIDZE D. (UKR)	199	UHREKHELIDZE D. (UKR)	203	UHREKHELIDZE D. (UKR)	210	UHREKHELIDZE D. (UKR)
199	UHREKHELIDZE D. (UKR)	200	UHREKHELIDZE D. (UKR)	204	UHREKHELIDZE D. (UKR)	211	UHREKHELIDZE D. (UKR)
200	UHREKHELIDZE D. (UKR)	201	UHREKHELIDZE D. (UKR)	205	UHREKHELIDZE D. (UKR)	212	UHREKHELIDZE D. (UKR)
201	UHREKHELIDZE D. (UKR)	202	UHREKHELIDZE D. (UKR)	206	UHREKHELIDZE D. (UKR)	213	UHREKHELIDZE D. (UKR)
202	UHREKHELIDZE D. (UKR)	203	UHREKHELIDZE D. (UKR)	207	UHREKHELIDZE D. (UKR)	214	UHREKHELIDZE D. (UKR)
203	UHREKHELIDZE D. (UKR)	204	UHREKHELIDZE D. (UKR)	208	UHREKHELIDZE D. (UKR)	215	UHREKHELIDZE D. (UKR)
204	UHREKHELIDZE D. (UKR)	205	UHREKHELIDZE D. (UKR)	209	UHREKHELIDZE D. (UKR)	216	UHREKHELIDZE D. (UKR)
205	UHREKHELIDZE D. (UKR)	206	UHREKHELIDZE D. (UKR)	210	UHREKHELIDZE D. (UKR)	217	UHREKHELIDZE D. (UKR)
206	UHREKHELIDZE D. (UKR)	207	UHREKHELIDZE D. (UKR)	211	UHREKHELIDZE D. (UKR)	218	UHREKHELIDZE D. (UKR)
207	UHREKHELIDZE D. (UKR)	208	UHREKHELIDZE D. (UKR)	212	UHREKHELIDZE D. (UKR)	219	UHREKHELIDZE D. (UKR)
208	UHREKHELIDZE D. (UKR)	209	UHREKHELIDZE D. (UKR)	213	UHREKHELIDZE D. (UKR)	220	UHREKHELIDZE D. (UKR)
209	UHREKHELIDZE D. (UKR)	210	UHREKHELIDZE D. (UKR)	214	UHREKHELIDZE D. (UKR)	221	UHREKHELIDZE D. (UKR)
210	UHREKHELIDZE D. (UKR)	211	UHREKHELIDZE D. (UKR)	215	UHREKHELIDZE D. (UKR)	222	UHREKHELIDZE D. (UKR)
211	UHREKHELIDZE D. (UKR)	212	UHREKHELIDZE D. (UKR)	216	UHREKHELIDZE D. (UKR)	223	UHREKHELIDZE D. (UKR)
212	UHREKHELIDZE D. (UKR)	213	UHREKHELIDZE D. (UKR)	217	UHREKHELIDZE D. (UKR)	224	UHREKHELIDZE D. (UKR)
213	UHREKHELIDZE D. (UKR)	214	UHREKHELIDZE D. (UKR)	218	UHREKHELIDZE D. (UKR)	225	UHREKHELIDZE D. (UKR)
214	UHREKHELIDZE D. (UKR)	215	UHREKHELIDZE D. (UKR)	219	UHREKHELIDZE D. (UKR)	226	UHREKHELIDZE D. (UKR)
215	UHREKHELIDZE D. (UKR)	216	UHREKHELIDZE D. (UKR)	220	UHREKHELIDZE D. (UKR)	227	UHREKHELIDZE D. (UKR)
216	UHREKHELIDZE D. (UKR)	217	UHREKHELIDZE D. (UKR)	221	UHREKHELIDZE D. (UKR)	228	UHREKHELIDZE D. (UKR)



Bielsko Biala Millennium Team Cadet European Cup 2026

Poland, Bielsko Biala, 16-17 May 2026

-73 kg

Men (60)

POOL A

OTEVREL Tomas	CZE
MURESAN Erik	ROU
DZIEPAK Ignacy	POL
KYCHA Tymofii	UKR
MAJOR Gabor	HUN
CYGAN Filip	POL
TONOV Ilija	BUL
NAZAR Yusuf	AZE
KILADZE Lazare	GER
YILMAZ Tahsin Efe	TUR
OKSENENKO Rodion	UKR
GAL Kristof	HUN
MISZTAL Daniel	POL
ALIKHANOV Amir	EST
ALA Edward	IRL

1	OTEVREL T. (CZE)	33	OTEVREL T. (CZE)
2	DZIEPAK I. (POL)	34	CYGAN F. (POL)
3	KYCHA T. (UKR)	35	NAZAR Y. (AZE)
4	CYGAN F. (POL)	36	GAL K. (HUN)
5	NAZAR Y. (AZE)		
6	YILMAZ T. (TUR)		
7	GAL K. (HUN)		
8	ALIKHANOV A. (EST)		

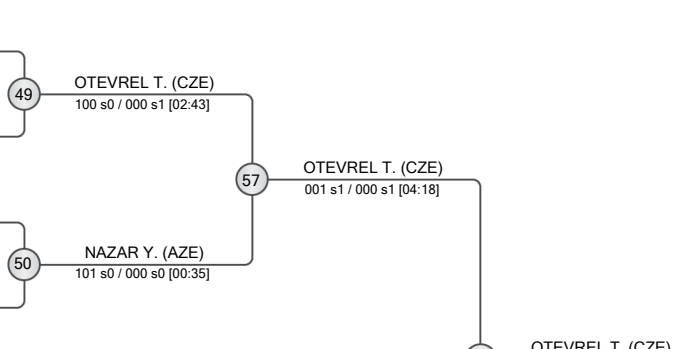

POOL B

YERKEN Bekali	KAZ
MARKSAITIS Matas	LTU
VASHCHENKO Oleksandr	POL
STINER Noam	ISR
NEMASIK Matej	SVK
ZEMLIANYI Kyrylo	POL
EXMELIN Elyes	FRA
BOJOVIC Ognjen	SRB
WOJTAN Damian	POL
STANJA Jonathan	GER
TERTYSHNYI Matvii	UKR
NAGY Aron	HUN
STEPINS Valters	LAT
LASCAU Tudor	ROU
WILKOSZ Szymon	POL

9	YERKEN B. (KAZ)	37	YERKEN B. (KAZ)
10	MARKSAITIS M. (LTU)	38	EXMELIN E. (FRA)
11	NEMASIK M. (SVK)	39	BOJOVIC O. (SRB)
12	ZEMLIANYI K. (POL)	40	WILKOSZ S. (POL)
13	BOJOVIC O. (SRB)		
14	TERTYSHNYI M. (UKR)		
15	NAGY A. (HUN)		
16	WILKOSZ S. (POL)		

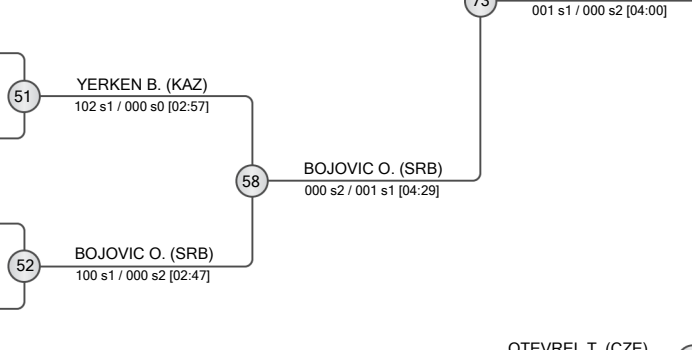

POOL C

ALEKSEJUNAS Natas	LTU
POHLMANN Willi-Balduin	GER
WOLNIAKOWSKI Karol	POL
HERCEG Oliver	SVK
LAPTIEV Daniil	UKR
WODZYNSKI Leon	POL
ROSU Liviu	MDA
FILONENKO Ruslan	UKR
IDZIKOWSKI Maciej	POL
LANTOS Levente	HUN
LE GUYADER Maxime	FRA
STANKOVIC Ilija	SRB
PETKOV Asen	BUL
AMANZHOL Baiadil	POL
STOEGMANN Stefan	AUT

17	ALEKSEJUNAS N. (LTU)	41	ALEKSEJUNAS N. (LTU)
18	POHLMANN W. (GER)	42	WODZYNSKI L. (POL)
19	LAPTIEV D. (UKR)	43	LE GUYADER M. (FRA)
20	WODZYNSKI L. (POL)	44	STANKOVIC I. (SRB)
21	FILONENKO R. (UKR)		
22	LE GUYADER M. (FRA)		
23	STANKOVIC I. (SRB)		
24	STOEGMANN S. (AUT)		

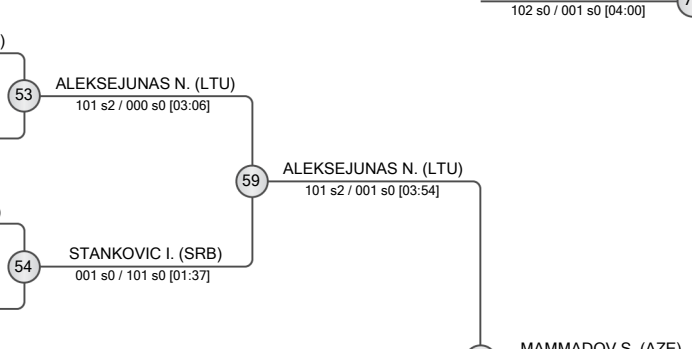

POOL D

MAMMADOV Sadig	AZE
PAVLOVIC Luka	SRB
MITOI Stefan	ROU
KNAP Tymoteusz	POL
DIVANOV Edi	BUL
BONA Zalan	HUN
MAULETKHAN Nuraly	KAZ
SCHUERER Hannes	GER
RODRIGUEZ LLORENS Biel	AND
WOZNIAK Marcel	POL
MARCHUK Yehor	UKR
ASANO Kento	AUS
MUSIAL Simon	CZE
KRAVETS Bohdan	POL
VAN LINGEN Tijn	NED

25	MAMMADOV S. (AZE)	45	MAMMADOV S. (AZE)
26	MITOI S. (ROU)	46	MAULETKHAN N. (KAZ)
27	KNAP T. (POL)	47	SCHUERER H. (GER)
28	MAULETKHAN N. (KAZ)	48	KRAVETS B. (POL)
29	SCHUERER H. (GER)		
30	MARCHUK Y. (UKR)		
31	MUSIAL S. (CZE)		
32	KRAVETS B. (POL)		

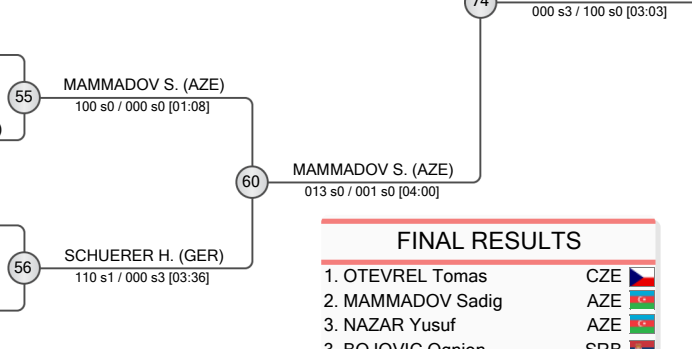

FINAL RESULTS

- OTEVREL Tomas (CZE)
- MAMMADOV Sadig (AZE)
- NAZAR Yusuf (AZE)
- BOJOVIC Ognjen (SRB)
- ALEKSEJUNAS Natas (LTU)
- MAULETKHAN Nuraly (KAZ)
- YERKEN Bekali (KAZ)
- POHLMANN Willi-Balduin (GER)

REPECHAGE

61	DZIEPAK I. (POL)	62	TERTYSHNYI M. (UKR)	63	POHLMANN W. (GER)	64	MITOI S. (ROU)
65	CYGAN F. (POL)	66	WILKOSZ S. (POL)	67	WODZYNSKI L. (POL)	68	MAULETKHAN N. (KAZ)
69	NAZAR Y. (AZE)	70	YERKEN B. (KAZ)	71	STANKOVIC I. (SRB)	72	SCHUERER H. (GER)

65	CYGAN F. (POL)	69	NAZAR Y. (AZE)	75	NAZAR Y. (AZE)	77	NAZAR Y. (AZE)
69	NAZAR Y. (AZE)	70	YERKEN B. (KAZ)	75	NAZAR Y. (AZE)	77	NAZAR Y. (AZE)
70	YERKEN B. (KAZ)	71	STANKOVIC I. (SRB)	76	MAULETKHAN N. (KAZ)	78	BOJOVIC O. (SRB)
71	STANKOVIC I. (SRB)	72	SCHUERER H. (GER)	76	MAULETKHAN N. (KAZ)	78	BOJOVIC O. (SRB)

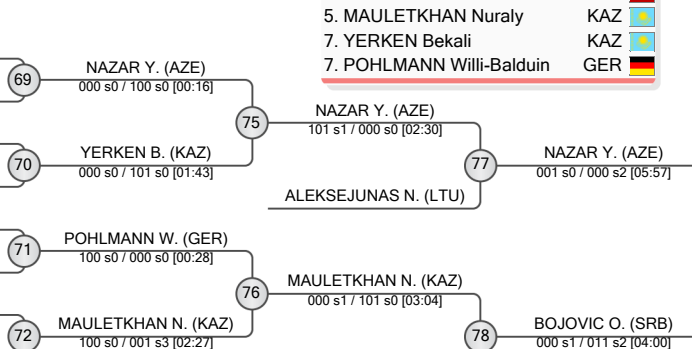



Bielsko Biala Millennium Team Cadet European Cup 2026

Poland, Bielsko Biala, 16-17 May 2026

-81 kg

Men (58)

POOL A

1	TOPP Kai (AUS)	33	TOPP K. (AUS)
2	NUX Alexandre (FRA)	34	HARCAVI A. (ISR)
3	TULIK Oliver (HUN)	35	HASANLI A. (AZE)
4	HARCAVI Adam (ISR)	36	FENSKI O. (GER)
5	TOLU Hasgul Efe (TUR)	37	MANDIC V. (SRB)
6	WIESENBERGER Till Louis (GER)	38	SAILAUBEKOV A. (KAZ)
7	PALA Michal (POL)	39	SHVETS I. (UKR)
8	HASANLI Aykhan (AZE)	40	BECK F. (GER)
9	HOLOVANOV Kyrylo (POL)	41	WIDECKI J. (POL)
10	STANKEVICIUS Ignas (LTU)	42	FACHIRIDIS S. (GER)
11	SUKHANOV Kostiantyn (UKR)	43	GENGASHVILI V. (GEO)
12	PETRE David (ROU)	44	CHARENKA K. (LTU)
13	CAMILOVIC Luka (SRB)	45	IURCOVSCHI D. (FRA)
14	FENSKI Ole (GER)	46	KILADZE G. (GER)
15	LUTAJ Igor (POL)	47	MATHUES S. (BEL)

POOL B

9	VALA Lukas (CZE)	37	MANDIC V. (SRB)
10	MANDIC Veljko (SRB)	38	SAILAUBEKOV A. (KAZ)
11	MINICH Michail (GER)	39	SHVETS I. (UKR)
12	TAMAZASHVILI Mate (GEO)	40	BECK F. (GER)
13	SAILAUBEKOV Alizhan (KAZ)	41	WIDECKI J. (POL)
14	STODOLNIK Szymon (POL)	42	FACHIRIDIS S. (GER)
15	PLACHKOV Stilyan (BUL)	43	GENGASHVILI V. (GEO)
16	SHVETS Illia (UKR)	44	CHARENKA K. (LTU)
17	DOBRZANSKIS Renats (LAT)	45	IURCOVSCHI D. (FRA)
18	KOZLOWSKI Mikolaj (POL)	46	KILADZE G. (GER)
19	SOLAN Maksymilian (POL)	47	MATHUES S. (BEL)
20	BECK Flynt (GER)	48	ERLICH R. (GER)
21	SUPAKHUNOV David (LTU)	49	HARCAVI A. (ISR)
22	VANCAK Milan (SVK)	50	HASANLI A. (AZE)

POOL C

17	SAKHAROV Nikita (UKR)	41	WIDECKI J. (POL)
18	WIDECKI Jakub (POL)	42	FACHIRIDIS S. (GER)
19	ADAMEC Maxmilian-Tomas (CZE)	43	GENGASHVILI V. (GEO)
20	VUCKOVIC Bogdan (SRB)	44	CHARENKA K. (LTU)
21	FACHIRIDIS Stavros (GER)	45	IURCOVSCHI D. (FRA)
22	ROSENBERG Yoav (ISR)	46	KILADZE G. (GER)
23	VAN WOENSEL Ties (NED)	47	MATHUES S. (BEL)
24	GENGASHVILI Vazha (GEO)	48	ERLICH R. (GER)
25	ANTUNOVIC Teo (CRO)	49	HARCAVI A. (ISR)
26	CIBUR Michal (SVK)	50	HASANLI A. (AZE)
27	WOLASEWICZ Wiktor (POL)	51	SAILAUBEKOV A. (KAZ)
28	MAZURKIEWICZ Tymon (POL)	52	BECK F. (GER)
29	PODKUJKO Igors (LAT)	53	SAKHAROV N. (UKR)
30	CHARENKA Kajus (LTU)	54	GENGASHVILI V. (GEO)
31	UNTERBERG Lev (GER)	55	MAMMADOV Y. (AZE)

POOL D

25	MAMMADOV Yagub (AZE)	45	IURCOVSCHI D. (FRA)
26	DIMITROV Plamen (BUL)	46	KILADZE G. (GER)
27	IURCOVSCHI Daniel (FRA)	47	MATHUES S. (BEL)
28	KILADZE Giga (GER)	48	ERLICH R. (GER)
29	MAJASKAS Aronas (LTU)	49	HARCAVI A. (ISR)
30	KOCHAN Marcel (POL)	50	HASANLI A. (AZE)
31	VELICKOVIC Vukasin (SRB)	51	SAILAUBEKOV A. (KAZ)
32	HERNADI Csanad (HUN)	52	BECK F. (GER)
33	KOBYLINSKI Wiktor (POL)	53	SAKHAROV N. (UKR)
34	MATHUES Sid (BEL)	54	GENGASHVILI V. (GEO)
35	MARTINEZ KOVAC Jan Estefano (SLO)	55	MAMMADOV Y. (AZE)
36	BOROJEVIC Veljko (SRB)	56	MATHUES S. (BEL)
37	ERLICH Roland (GER)	57	HASANLI A. (AZE)
38	CZUMACZENKO Jaroslaw (POL)	58	SAILAUBEKOV A. (KAZ)

REPECHAGE

61	HOLOVANOV K. (POL)	65	FENSKI O. (GER)
62	STANKEVICIUS I. (LTU)	66	TAMAZASHVILI M. (GEO)
63	TAMAZASHVILI M. (GEO)	67	FACHIRIDIS S. (GER)
64	PLACHKOV S. (BUL)	68	KILADZE G. (GER)
65	MANDIC V. (SRB)	69	HARCAVI A. (ISR)
66	WIDECKI J. (POL)	70	BECK F. (GER)
67	FACHIRIDIS S. (GER)	71	FACHIRIDIS S. (GER)
68	IURCOVSCHI D. (FRA)	72	KILADZE G. (GER)
69	FENSKI O. (GER)	73	HASANLI A. (AZE)
70	HARCAVI A. (ISR)	74	SAKHAROV N. (UKR)
71	FACHIRIDIS S. (GER)	75	BECK F. (GER)
72	KILADZE G. (GER)	76	FACHIRIDIS S. (GER)
73	HASANLI A. (AZE)	77	MAMMADOV Y. (AZE)
74	SAKHAROV N. (UKR)	78	SAILAUBEKOV A. (KAZ)

FINAL RESULTS

1. SAKHAROV Nikita (UKR)
2. HASANLI Aykhan (AZE)
3. MAMMADOV Yagub (AZE)
3. SAILAUBEKOV Alizhan (KAZ)
5. BECK Flynt (GER)
5. FACHIRIDIS Stavros (GER)
7. HARCAVI Adam (ISR)
7. KILADZE Giga (GER)





Bielsko Biala Millennium Team Cadet European Cup 2026

Poland, Bielsko Biala, 16-17 May 2026

-90 kg

Men (41)

POOL A

	KELLY Akos	AUS
	MRUCZEK Bartosz	POL
	ALIYEV Nuraddin	AZE
	AGERON Enzo	FRA
	TRUUVERK Huud-Keerit	EST
	GOLTZ Jerome	GER
	DARULIS Arturas	LTU
	ZIELONKA Jakub	POL
	VUKOVIC Ilija	SRB
	TANGIRBERGEN Shynggyskhan	KAZ
	BOOMKAMP Marinus	NED

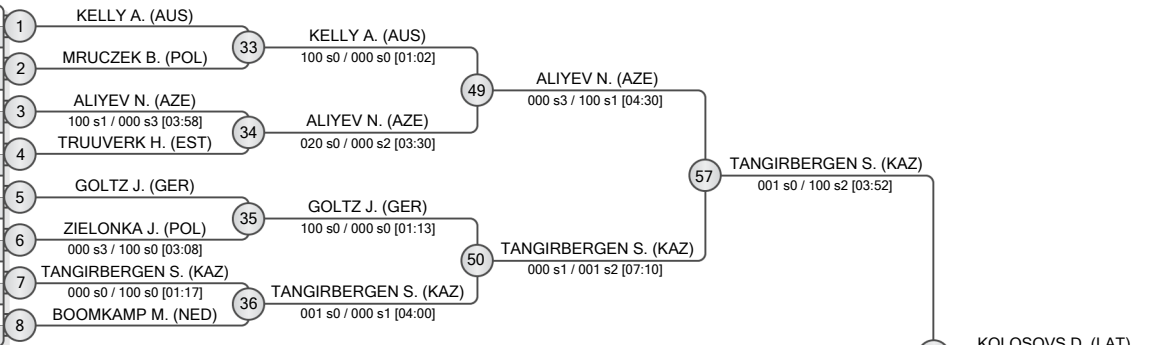

POOL B

	KOLOSOVS Dmitrijs	LAT
	FARAFONOV Matvii	UKR
	BRZEZINSKI Bartosz	POL
	SEBELKA Hugo	CZE
	AL-HASSANI Saged	GER
	MARKOVIC Arian	CRO
	CELIK Yusuf Taha	TUR
	PAWLAK Bartlomiej	POL
	SIDLAUSKAS Jokubas	LTU
	MOGILNI Kirill	ISR

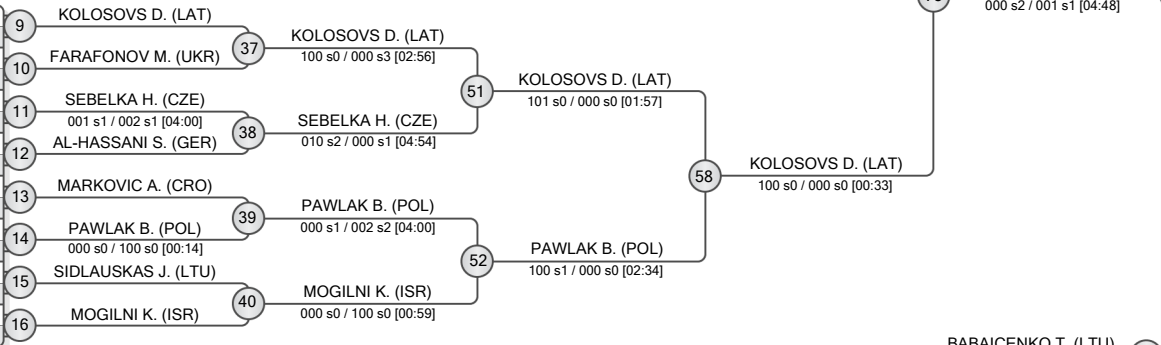

POOL C

	BABAICENKO Tajus	LTU
	NAUTA Jacob	NED
	SIKORSKI Antoni	POL
	KISSK Julian Henryk	GER
	SIPUSIC Jan	CRO
	AKHUNDOV Omar	AZE
	SHNIDER Omer	ISR
	ALIASKAROV Alikhan	KAZ
	GINGA Alexandru	IRL
	KALYNIAC Oleh	UKR

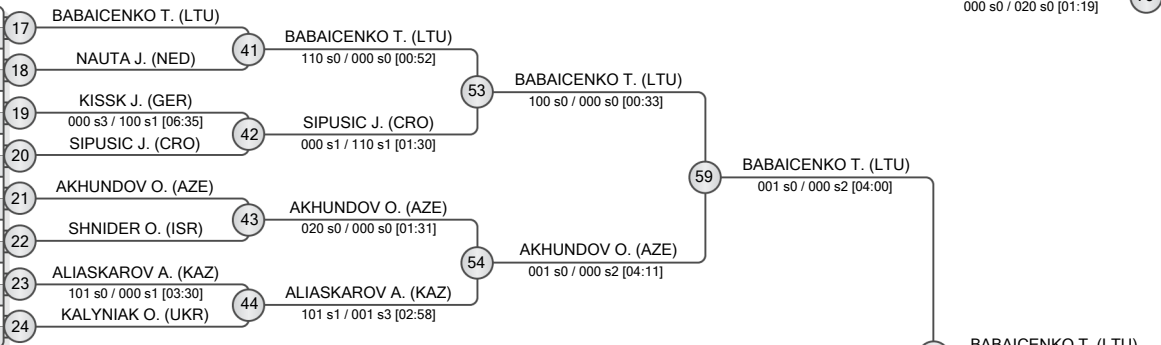

POOL D

	SCHEIBER Felix	AUT
	DENNEMONT Sam	FRA
	FIODOROVAS Joris	LTU
	LAJCAK Ondrej	CZE
	SZCZESNIAK Igor	POL
	KONYSBEK Shynggys	KAZ
	ZIELINSKI Szymon	POL
	MADDALOZZO Luis	AUS
	CEPERKO Jakub	SVK
	KONOPLYANYK Nikolai	BEL

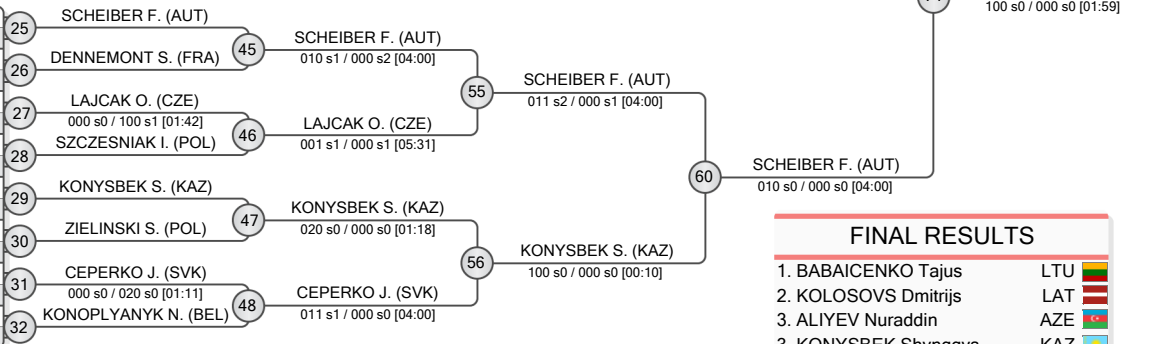

FINAL RESULTS		
1.	BABAICENKO Tajus	LTU
2.	KOLOSOVS Dmitrijs	LAT
3.	ALIYEV Nuraddin	AZE
3.	KONYSBEK Shynggys	KAZ
5.	SCHEIBER Felix	AUT
5.	TANGIRBERGEN Shynggyskhan	KAZ
7.	PAWLAK Bartlomiej	POL
7.	AKHUNDOV Omar	AZE

REPECHAGE

VUKOVIC I. (SRB)	61	VUKOVIC I. (SRB)	65	VUKOVIC I. (SRB)	69
BOOMKAMP M. (NED)	62	FARAFONOV M. (UKR)	66	FARAFONOV M. (UKR)	70
FARAFONOV M. (UKR)	63	SEBELKA H. (CZE)	67	PAWLAK B. (POL)	71
NAUTA J. (NED)	64	NAUTA J. (NED)	68	AKHUNDOV O. (AZE)	72
DENNEMONT S. (FRA)		SIPUSIC J. (CRO)		DENNEMONT S. (FRA)	
		DENNEMONT S. (FRA)		LAJCAK O. (CZE)	

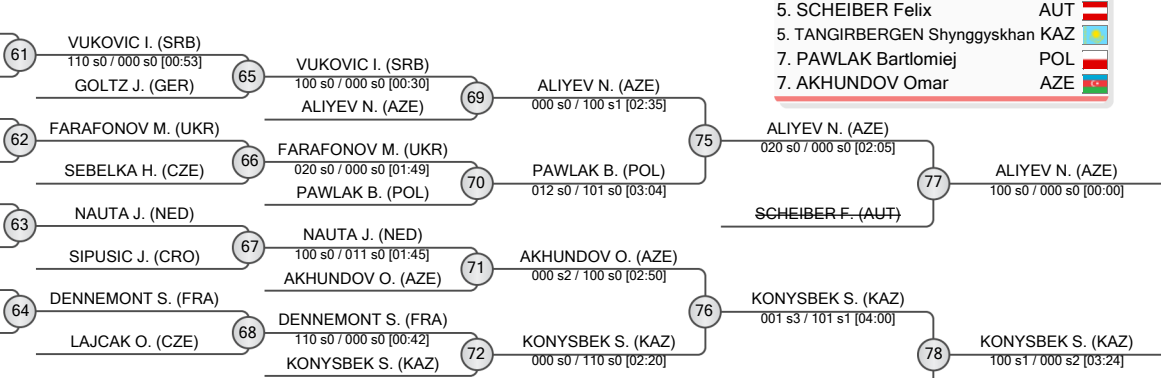



Bielsko Biala Millennium Team Cadet European Cup 2026

Poland, Bielsko Biala, 16-17 May 2026

+ 90 kg

Men (32)

POOL A

	ZHAUDINOV Adilzhan	KAZ
	CUROVIC Aleksa	BIH
	KASZA Kacper	POL
	MARIJAN Ognjen	SRB
	ROBAKIDZE Temuri	GEO
	KLEBEK Jan	POL
	BRUINING Joshua	NED
	TIUKH Yurii	UKR

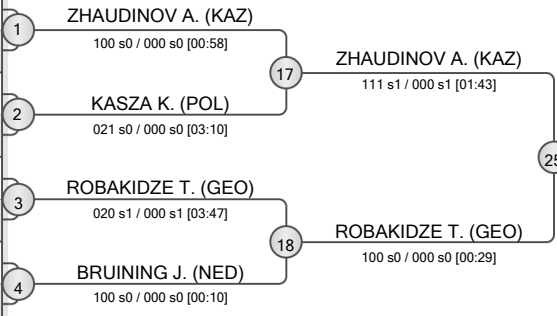

POOL B

	DEKENNE DIFFO Azriel	FRA
	BEGIC Ivan	GER
	ALIYEV Tamerlan	AZE
	JUSINSKI Aleksander	POL
	JUMABAY Yerdaulet	KAZ
	ATAMAN Omer Bartu	TUR
	BRUNNER Jan	CZE
	ZMIJEWSKI Jakub	POL

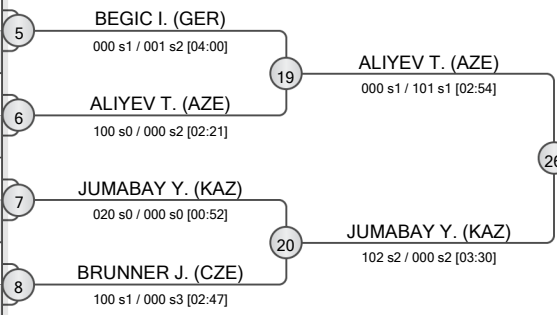

POOL C

	SKODA Melichar	CZE
	BUURAL Tamir	POL
	GURSKIJ Gabriel	LTU
	NURAKHMETOV Yermurat	KAZ
	VUJICA Marko	CRO
	KUZMENKO Platon	UKR
	DELEVIC Luka	SRB
	STETTINSKY Lucas	GER

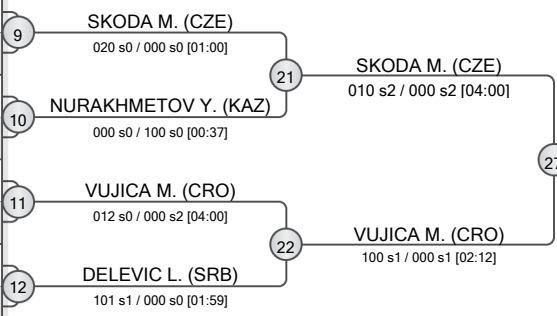

POOL D

	LUBURA Nikola	BIH
	KAZIMOV Ruslan	AZE
	NOVOTNY Jaroslav	CZE
	KIERSTEIN Marcel	POL
	APSALONS Aleksandrs	LAT
	BRAUSEWETTER Maarten	GER
	BADEA Petru	ROU
	KANTARIA Aleksandre	POL

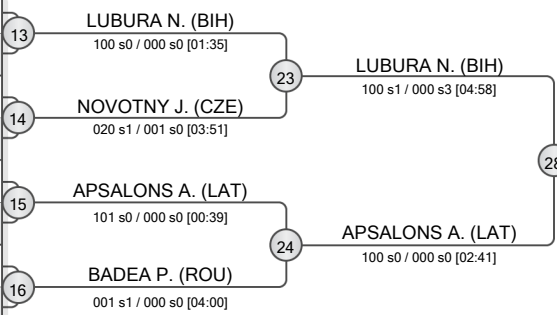

FINAL RESULTS	
1.	ZHAUDINOV Adilzhan KAZ
2.	LUBURA Nikola BIH
3.	VUJICA Marko CRO
3.	SKODA Melichar CZE
5.	ROBAKIDZE Temuri GEO
5.	JUMABAY Yerdaulet KAZ
7.	ALIYEV Tamerlan AZE
7.	APSALONS Aleksandrs LAT

REPECHAGE

CUROVIC A. (BIH)	29 CUROVIC A. (BIH)	33 ROBAKIDZE T. (GEO)
KASZA K. (POL)	020 s0 / 000 s0 [01:07]	012 s0 / 101 s0 [02:32]
ATAMAN O. (TUR)	ROBAKIDZE T. (GEO)	39 ROBAKIDZE T. (GEO)
BRUNNER J. (CZE)	30 BRUNNER J. (CZE)	001 s2 / 000 s1 [04:00]
BRUNNER J. (CZE)	000 s1 / 100 s0 [02:38]	41 VUJICA M. (CRO)
KUZMENKO P. (UKR)	31 DELEVIC L. (SRB)	000 s0 / 100 s1 [01:20]
DELEVIC L. (SRB)	000 s0 / 110 s0 [01:42]	40 SKODA M. (CZE)
KAZIMOV R. (AZE)	32 NOVOTNY J. (CZE)	100 s2 / 000 s2 [04:12]
NOVOTNY J. (CZE)	000 s0 / 101 s0 [01:37]	42 SKODA M. (CZE)
NOVOTNY J. (CZE)	36 APSALONS A. (LAT)	100 s1 / 001 s0 [02:53]
NOVOTNY J. (CZE)	000 s3 / 100 s0 [04:30]	JUMABAY Y. (KAZ)





Bielsko Biala Millennium Team Cadet European Cup 2026

Poland, Bielsko Biala, 16-17 May 2026

-40 kg

Women (17)

POOL A

	GRACOVA Dominika	CZE
	KROT Kateryna	UKR
	MARIAN Daria	ROU
	ZIELINSKA Aleksandra	POL

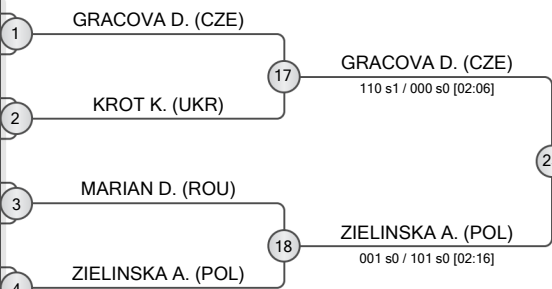

POOL B

	PIRBUS-GROF Nora	HUN
	PHAM Serra	NED
	SALAMOVA Sunay	AZE
	AITBAY Zhanel	KAZ

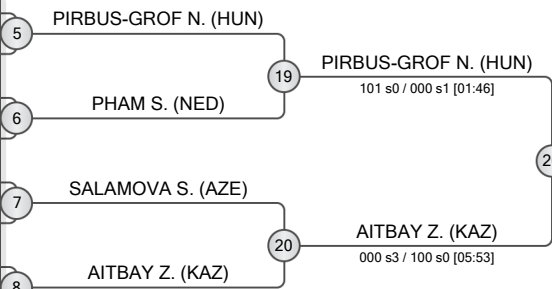

POOL C

	LAVERGNE Joanne	FRA
	ZHANDARBAY Kaussar	KAZ
	HRYHORENKO Anna	UKR
	LUDVIG Amalia	ROU
	BREM Nawaii	NED

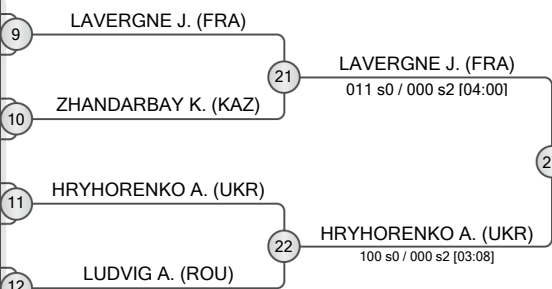

POOL D

	ZHANAKHMET Adiya	KAZ
	KLYS Karolina	POL
	GAT MUALEM Avigayil	ISR
	GULIYEVA Zahra	AZE

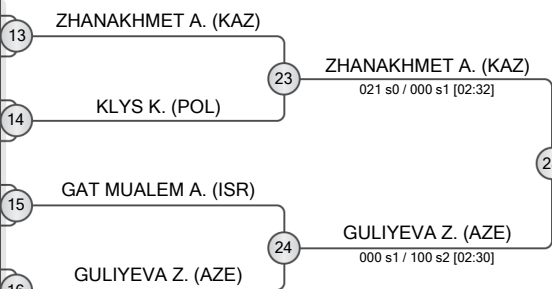

REPECHAGE

29	KROT K. (UKR)
30	PHAM S. (NED)
31	LUDVIG A. (ROU)
32	GAT MUALEM A. (ISR)

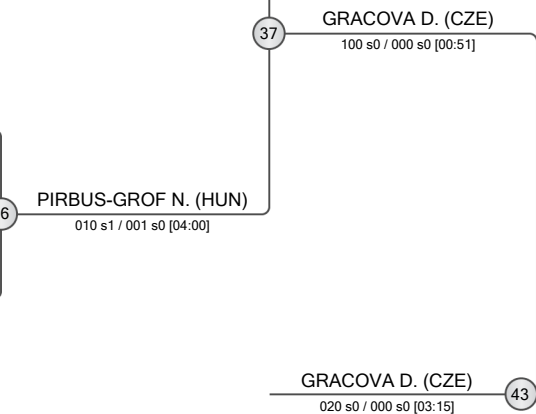
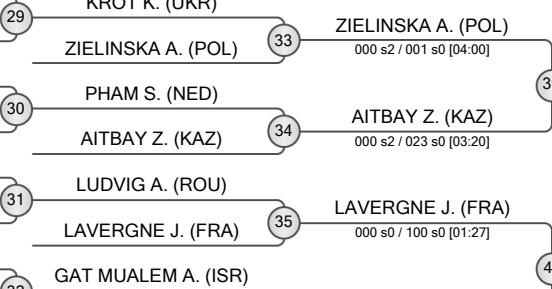

FINAL RESULTS		
1.	GRACOVA Dominika	CZE
2.	GULIYEVA Zahra	AZE
3.	AITBAY Zhanel	KAZ
3.	GAT MUALEM Avigayil	ISR
5.	HRYHORENKO Anna	UKR
5.	PIRBUS-GROF Nora	HUN
7.	ZIELINSKA Aleksandra	POL
7.	LAVERGNE Joanne	FRA





Bielsko Biala Millennium Team Cadet European Cup 2026

Poland, Bielsko Biala, 16-17 May 2026

-44 kg

Women (22)

POOL A

	BLASZCZYK Julia	POL
	KILACKOVA Silvia	SVK
	SOFFER Lihi	ISR
	ABDULLAYEVA Fatima	AZE
	NASKOVIC Nina	SRB

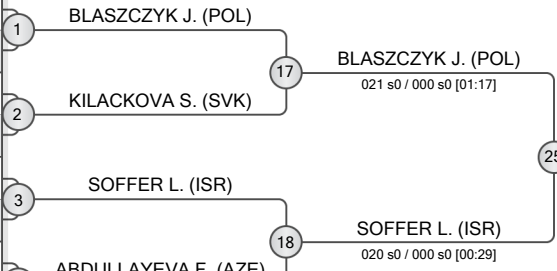

POOL B

	TAKACS Nora	HUN
	PAPATHEODOROU Io Eirini	GRE
	SOUBIELLE Maia	FRA
	VOROPAIEVA Viktoriia	UKR
	WISNIEWSKA Julia	POL
	MICHI Vivian Marie	GER

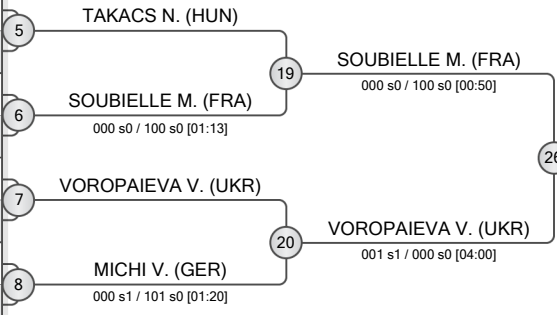

POOL C

	JOLY Ninon	FRA
	ANDRZEJUK Zuzanna	POL
	CIUMAS Bianca	ROU
	GRAVENSTIJN Tracey	NED
	SEVKHANLI Parvin	AZE

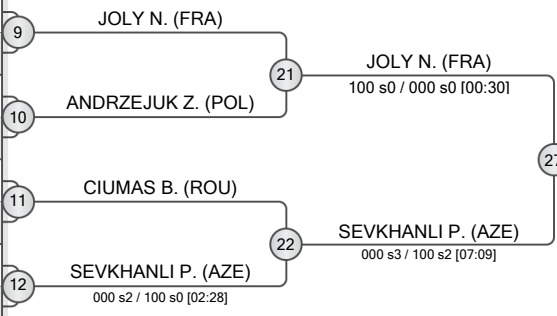

POOL D

	SAKHABADIN Inzhu	KAZ
	ZABAWCZUK Aleksandra	POL
	FEDORA Emma	HUN
	PEETERS Fenne	BEL
	LUKASHEVSKA Nadiia	LTU
	PUHACH Anna	UKR

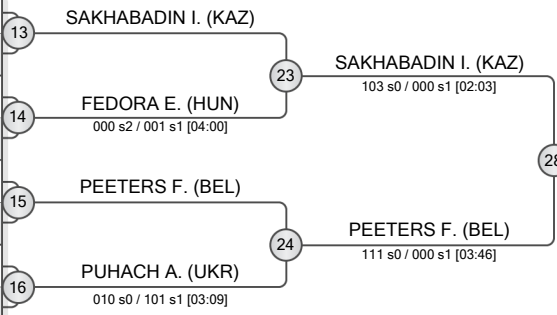

REPECHAGE

29	KILACKOVA S. (SVK)
30	MICHI V. (GER)
31	CIUMAS B. (ROU)
32	PUHACH A. (UKR)

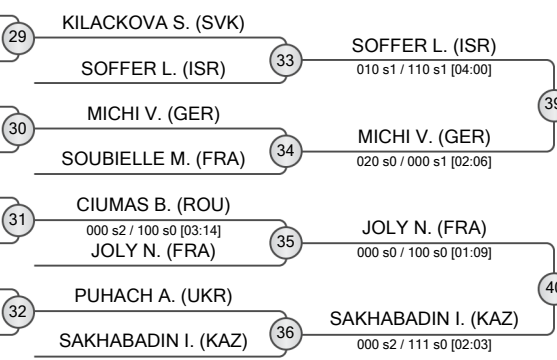

FINAL RESULTS	
1.	PEETERS Fenne (BEL)
2.	BLASZCZYK Julia (POL)
3.	SEVKHANLI Parvin (AZE)
3.	SAKHABADIN Inzhu (KAZ)
5.	MICHI Vivian Marie (GER)
5.	VOROPAIEVA Viktoriia (UKR)
7.	SOFFER Lihi (ISR)
7.	JOLY Ninon (FRA)





Bielsko Biala Millennium Team Cadet European Cup 2026

Poland, Bielsko Biala, 16-17 May 2026

-48 kg

Women (48)

POOL A

1	DAPA Maelys (BEL)	33	DAPA M. (BEL)
2	ZAECH Helena (SUI)	34	GUT L. (POL)
3	ARMANOWSKA Nina (POL)	35	HLUSHCHENKO T. (UKR)
4	SOARES Maria (POR)	36	ZHUBATKAN I. (KAZ)
5	PANTIC Teodora (SRB)	37	THUIJLS N. (NED)
6	GUT Lena (POL)	38	KUCEROVA Elena (SVK)
7	HLUSHCHENKO Tetiana (UKR)	39	ZHUBATKAN Iyanat (KAZ)
8	THUIJLS Nika (NED)	40	BRUNNETT Hanna (GER)
	KUCEROVA Elena (SVK)		CHMIELEWSKA Nela (POL)

POOL B

9	EYVAZLI Konul (AZE)	41	GORANOVIC K. (SRB)
10	KUNYIK Laura-Sophie (AUT)	42	RAKHIMZHANOVA S. (KAZ)
11	KARIMANOVA Polin (BUL)	43	FARMANZADE F. (AZE)
12	CZERWINSKA-KOWAR Karina (POL)	44	COOK A. (AUS)
13	CEDRONOVA Zuzana (CZE)	45	OMELCHENKO Kateryna (LTU)
14	BERTRANDO Inae (FRA)	46	CALINSKA Lena (POL)
15	BAR LEV Ella (ISR)	47	MARTINEZ Navia (BEL)
16	KRUZA Zuzanna (POL)	48	LNENICKOVA Julie (CZE)
	SHVAIGERT Zlata (KAZ)		PIETRASIK Iga (POL)
	FILIPOVIC Mia (SRB)		
	CIESLIK Anita (POL)		
	BEERMANN Mia Marie (GER)		

POOL C

17	PODYMSKA Nina (POL)	49	DAPA M. (BEL)
18	RADICS Maja (HUN)	50	ZHUBATKAN I. (KAZ)
19	GORANOVIC Katarina (SRB)	51	EYVAZLI K. (AZE)
20	RAKHIMZHANOVA Shakhshanam (KAZ)	52	BEERMANN M. (GER)
21	CARVALHO Mariana (POR)	53	PODYMSKA N. (POL)
22	FARMANZADE Fatima (AZE)	54	CALINSKA L. (POL)
23	COOK Abbey (AUS)	55	NOY A. (ISR)
24	OMELCHENKO Kateryna (LTU)	56	TALGATKYZY Z. (KAZ)
	CALINSKA Lena (POL)		KONOPA J. (POL)
	MARTINEZ Navia (BEL)		STEBLIEVA P. (UKR)
	LNENICKOVA Julie (CZE)		
	PIETRASIK Iga (POL)		

POOL D

25	NOY Agam Sol (ISR)	57	DAPA M. (BEL)
26	GRIGORYAN Viktoria (BEL)	58	EYVAZLI K. (AZE)
27	TRZPIL Lena (POL)	59	PODYMSKA N. (POL)
28	ROGOJINARU Adelina (ROU)	60	NOY A. (ISR)
29	HERMAN Jadwiga (POL)	61	ARMANOWSKA N. (POL)
30	STEFANIE Mamitantly Oceana (FRA)	62	KUNYIK L. (AUT)
31	TALGATKYZY Zere (KAZ)	63	GORANOVIC K. (SRB)
32	ROEDER Zoe (GER)	64	GRIGORYAN V. (BEL)
	MANTAIEVA Jasmina (AUT)		STEFANIE M. (FRA)
	KONOPA Julia (POL)		
	NIJHUIS Jelena (NED)		
	STEBLIEVA Polina (UKR)		

REPECHAGE

61	ARMANOWSKA N. (POL)	65	GUT L. (POL)
62	KUNYIK L. (AUT)	66	KUNYIK L. (AUT)
63	GORANOVIC K. (SRB)	67	RAKHIMZHANOVA S. (KAZ)
64	GRIGORYAN V. (BEL)	68	STEFANIE M. (FRA)
65	GUT L. (POL)	69	ZHUBATKAN I. (KAZ)
66	KUNYIK L. (AUT)	70	BEERMANN M. (GER)
67	RAKHIMZHANOVA S. (KAZ)	71	CALINSKA L. (POL)
68	STEFANIE M. (FRA)	72	TALGATKYZY Z. (KAZ)
69	ZHUBATKAN I. (KAZ)	73	EYVAZLI K. (AZE)
70	KUNYIK L. (AUT)	74	PODYMSKA N. (POL)
71	CALINSKA L. (POL)	75	ZHUBATKAN I. (KAZ)
72	TALGATKYZY Z. (KAZ)	76	TALGATKYZY Z. (KAZ)
73	EYVAZLI K. (AZE)	77	ZHUBATKAN I. (KAZ)
74	PODYMSKA N. (POL)	78	TALGATKYZY Z. (KAZ)
75	ZHUBATKAN I. (KAZ)		
76	TALGATKYZY Z. (KAZ)		
77	ZHUBATKAN I. (KAZ)		
78	TALGATKYZY Z. (KAZ)		

FINAL RESULTS	
1.	EYVAZLI Konul (AZE)
2.	PODYMSKA Nina (POL)
3.	ZHUBATKAN Iyanat (KAZ)
3.	TALGATKYZY Zere (KAZ)
5.	NOY Agam Sol (ISR)
5.	DAPA Maelys (BEL)
7.	KUNYIK Laura-Sophie (AUT)
7.	CALINSKA Lena (POL)





Bielsko Biala Millennium Team Cadet European Cup 2026

Poland, Bielsko Biala, 16-17 May 2026

-52 kg

Women (45)

POOL A

1	BRODALA Helena (POL)	1	BRODALA H. (POL)
2	TUERK Helin (AUT)	2	TUERK H. (AUT)
3	RUTKOWSKA Ludwika (POL)	3	RUTKOWSKA L. (POL)
4	PJATECKA Varvara (LAT)	4	PJATECKA V. (LAT)
5	PIELOCH Oliwia (POL)	5	PIELOCH O. (POL)
6	BUZINA Anastasia (EST)	6	WELLEKENS A. (BEL)
7	WELLEKENS Amelie (BEL)	7	KUKIC L. (GER)
8	RAFFAY Zsafia (HUN)	8	RASIC M. (SRB)
	KUKIC Lana (GER)		
	RASIC Mara (SRB)		

POOL B

9	VADOVICOVA Vivien (SVK)	9	VADOVICOVA V. (SVK)
10	MOVLAMVERDIYEVA Zahra (AZE)	10	GLIJER A. (POL)
11	GLIJER Amelia (POL)	11	HIROSE R. (AUS)
12	LABIAUX Lily-Rose (FRA)	12	WEGELER B. (GER)
13	HIROSE Rika (AUS)	13	VUKASOVIC Teodora (SRB)
14	WEGELER Babette (GER)	14	GERINGER X. (GER)
15	VUKASOVIC Teodora (SRB)	15	LARSEN R. (SUI)
16	GERINGER Xenia (GER)	16	SZCZEPANSKA J. (POL)
	PAPATHEODOROU Evangelia (GRE)		
	LARSEN Ria (SUI)		
	CHERKESOVA Maria (BUL)		
	SZCZEPANSKA Julia (POL)		

POOL C

17	KYRYLCHUK Kseniia (UKR)	17	KYRYLCHUK K. (UKR)
18	PURIC Nadja (SRB)	18	BURZYNSKA P. (POL)
19	BURZYNSKA Patrycja (POL)	19	REITMANN A. (GER)
20	JACKEVICIUTE Karolina (LTU)	20	FINDRIK P. (CRO)
21	REITMANN Anna (GER)	21	MERKVILADZE S. (GEO)
22	FINDRIK Paula (CRO)	22	SCHRODL E. (HUN)
23	MERKVILADZE Salome (GEO)	23	PAWLOWSKA S. (POL)
24	SCHRODL Emma (HUN)	24	WOERNER D. (GER)
	GOULART Vitoria (POR)		
	PAWLOWSKA Selenia (POL)		
	WOERNER Daphne (GER)		

POOL D

25	YAHAV Yali (ISR)	25	YAHAV Y. (ISR)
26	MANTYKENTTA Sara (FIN)	26	MANTYKENTTA S. (FIN)
27	BORUCINSKA Matylda (POL)	27	SOCHACKA N. (POL)
28	SOCHACKA Nela (POL)	28	AIDARKYZY D. (KAZ)
29	AIDARKYZY Damira (KAZ)	29	KOTOVA K. (UKR)
30	KOTOVA Kateryna (UKR)	30	DOUMBIA S. (FRA)
31	DOUMBIA Salma (FRA)	31	STOEGMANN I. (AUT)
32	BABAYEVA Tovsiyya (AZE)	32	TSIONARAS D. (GER)
	STOEGMANN Isabella (AUT)		
	KOMANDER Maja (POL)		
	TSIONARAS Dora Eleana (GER)		

REPECHAGE

61	TUERK H. (AUT)	61	TUERK H. (AUT)
62	LABIAUX L. (FRA)	62	WEGELER B. (GER)
63	WEGELER B. (GER)	63	BURZYNSKA P. (POL)
64	BURZYNSKA P. (POL)	64	TSIONARAS D. (GER)
	KOMANDER M. (POL)		
	TSIONARAS D. (GER)		

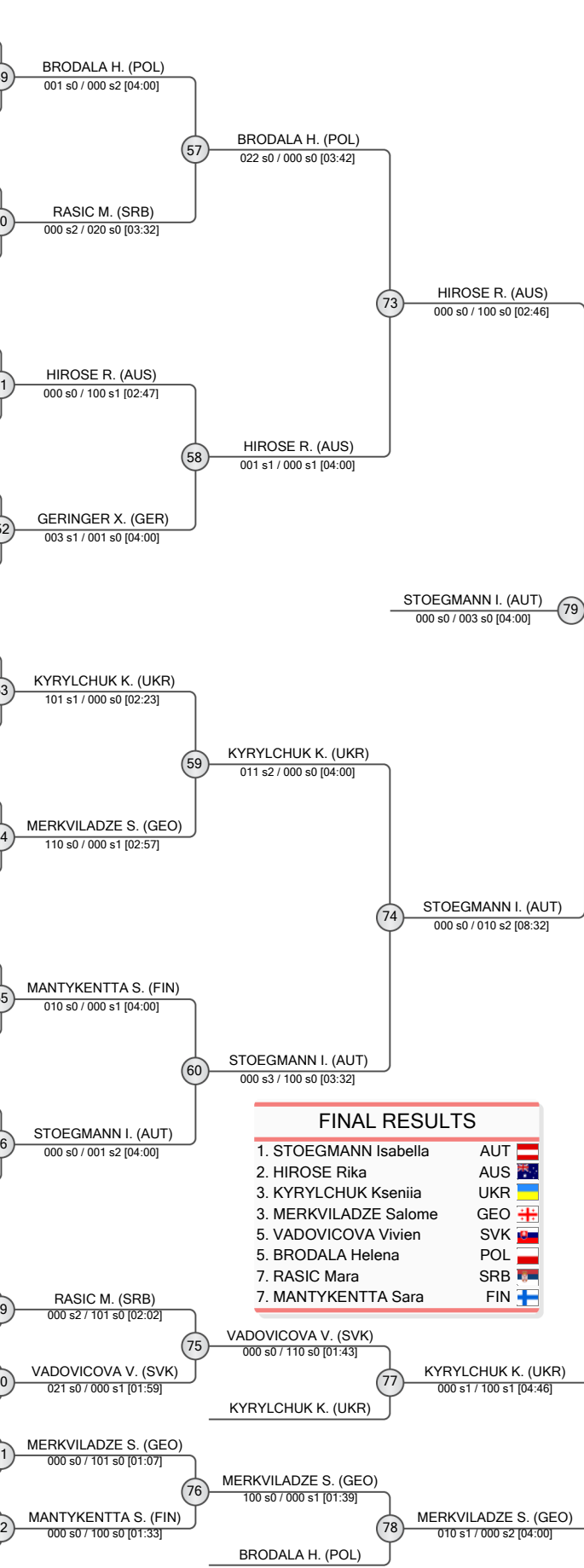

FINAL RESULTS		
1.	STOEGMANN Isabella	AUT
2.	HIROSE Rika	AUS
3.	KYRYLCHUK Kseniia	UKR
3.	MERKVILADZE Salome	GEO
5.	VADOVICOVA Vivien	SVK
5.	BRODALA Helena	POL
7.	RASIC Mara	SRB
7.	MANTYKENTTA Sara	FIN





Bielsko Biala Millennium Team Cadet European Cup 2026

Poland, Bielsko Biala, 16-17 May 2026

-57 kg

Women (64)

POOL A

ZHUMAZHAN Inzhu	KAZ	1	ZHUMAZHAN I. (KAZ)	111 s1 / 000 s0 [02:23]	33	ZHUMAZHAN I. (KAZ)	100 s1 / 000 s0 [02:22]
ZINK Maxima	GER		KIELBASA N. (POL)	000 s1 / 020 s0 [01:46]			
GRAJAUSKAITE Samanta	LTU	2	PAJERICH A. (HUN)	002 s0 / 003 s1 [04:00]			
KIELBASA Nadia	POL		YUSIFLI S. (AZE)	010 s2 / 011 s1 [04:00]	34	YUSIFLI S. (AZE)	010 s2 / 011 s1 [04:00]
VOJDOVA Zoe	SVK	3	YUSIFLI S. (AZE)	110 s0 / 000 s0 [03:52]			
PAJERICH Anna	HUN		BAILLEUL H. (FRA)	000 s2 / 100 s0 [04:00]	35	BAILLEUL H. (FRA)	100 s0 / 000 s1 [00:44]
YUSIFLI Samaya	AZE	4	VALSAMI I. (GRE)	000 s0 / 020 s0 [00:28]			
NICIFOROVIC Djurdja	SRB		RIEZNIK V. (UKR)	100 s1 / 001 s0 [02:04]	36	VYNSOVA A. (CZE)	000 s3 / 100 s2 [09:49]
SIEMKO Julia	POL	5	VYNSOVA A. (CZE)	102 s1 / 000 s0 [03:41]			
BAILLEUL Helea	FRA						
KULIKAUSKAITE Leja	LTU	6					
VALSAMI Iris	GRE						
RIEZNIK Vladyslava	UKR	7					
MOKRY Sandra	POL						
VYNSOVA Anna	CZE						
STROESSLIN Leonie	SUI	8					

POOL B

BARTYIK Iza Szofia	HUN	9	BARTYIK I. (HUN)	101 s0 / 000 s0 [00:51]	37	BARTYIK I. (HUN)	100 s0 / 000 s0 [01:41]
JANSEN Marie-Lise	BEL		SEMBEK Y. (KAZ)	020 s0 / 000 s0 [00:28]			
SEMBEK Yerkenaz	KAZ	10	NARRAIN K. (GER)	000 s3 / 100 s0 [04:27]	38	NARRAIN K. (GER)	010 s0 / 000 s1 [04:00]
RAIENKO Polina	UKR		HIETANEN-LIN C. (FIN)	021 s1 / 000 s1 [02:41]			
KMITA Lucja	POL	11	MEKAITON S. (ISR)	000 s0 / 100 s0 [00:00]	39	MEKAITON S. (ISR)	021 s0 / 001 s0 [01:37]
NARRAIN Katharina	GER		BORCZ B. (POL)	000 s0 / 001 s0 [04:00]			
HIETANEN-LIN Carolina	FIN	12	GUZINA V. (MNE)	001 s1 / 000 s1 [04:00]	40	GUZINA V. (MNE)	001 s0 / 000 s0 [04:00]
GAIGALAITÉ Monika	LTU		NEBHUTH S. (GER)	000 s1 / 002 s0 [04:00]			
GAIGALAITÉ Monika	LTU						
FATRISHVILI Sopie	GEO	13					
MEKAITON Shira	ISR						
PEREKOVIC Tena	CRO	14					
BORCZ Blanka	POL						
GUZINA Vanja	MNE	15					
JACHIMOWICZ Zuzanna	POL						
CIKARIC Dunja	SRB						
NEBHUTH Sophia	GER	16					

POOL C

CARAVELLO Lisa	AUS	17	CARAVELLO L. (AUS)	100 s0 / 000 s1 [01:17]	41	CARAVELLO L. (AUS)	100 s0 / 000 s0 [00:41]
CIBULKOVA Nela	SVK		HASID D. (ISR)	021 s0 / 000 s0 [03:51]			
HASID Daniella	ISR	18	GRUBER M. (GER)	000 s1 / 101 s0 [02:49]	42	BALABAN S. (UKR)	000 s0 / 100 s0 [03:28]
LUOTO Ella	FIN		SZERWINSKA Ewa	000 s0 / 100 s0 [01:08]			
RICHARDSON Sofia	IRL	19	CEPELAKOVA L. (CZE)	021 s0 / 000 s0 [00:53]	43	CEPELAKOVA L. (CZE)	100 s0 / 000 s0 [00:22]
GRUBER Michelle	GER		LOGONDER T. (SLO)	000 s0 / 020 s0 [01:08]			
SZERWINSKA Ewa	POL	20	HOLOVATIUK L. (UKR)	100 s2 / 000 s3 [07:49]	44	SIMONIA L. (GEO)	000 s1 / 110 s0 [01:26]
BALABAN Sofia	UKR		SIMONIA L. (GEO)	000 s1 / 100 s0 [01:57]			
CEPELAKOVA Lucie	CZE	21					
MALINOWSKA Martyna	POL						
STOJANOV Lenka	SRB	22					
LOGONDER Tjasa	SLO						
HOLOVATIUK Liubov	UKR	23					
BRAZINSKAITE Ieva	LTU						
SLADOWSKA Gabriela	POL	24					
SIMONIA Lizi	GEO						

POOL D

CIUPEK Jagoda	POL	25	CIUPEK J. (POL)	020 s0 / 000 s1 [01:45]	45	CIUPEK J. (POL)	100 s0 / 000 s1 [02:22]
MITRAN Antonia Maria	ROU		PALLAI D. (HUN)	100 s0 / 000 s2 [03:40]			
PALLAI Dora	HUN	26	BAECHLE S. (GER)	000 s2 / 100 s2 [02:40]	46	BAECHLE S. (GER)	100 s0 / 000 s0 [02:49]
MAMMADTAGHIYeva Gulnaz	AZE		BARANOWSKA L. (POL)	000 s0 / 020 s0 [01:26]			
LOZOVYUK Daria	UKR	27	KILDEEVA D. (FIN)	000 s0 / 010 s1 [04:00]	47	PULJIC L. (CRO)	000 s0 / 100 s0 [02:03]
BAECHLE Sophia	GER		PULJIC L. (CRO)	000 s3 / 110 s1 [02:04]			
STUMBREVICIUTE Daniela	LTU	28	VAN BAAL S. (NED)	000 s2 / 001 s1 [04:59]	48	KRONENTHAL C. (GER)	000 s2 / 101 s1 [04:00]
BARANOWSKA Lena	POL		KRONENTHAL C. (GER)	101 s0 / 000 s0 [03:54]			
LOURENCO Rita	POR	29					
KILDEEVA Daria	FIN						
REVEILLON Louanne	FRA	30					
PULJIC Lucija	CRO						
TOLEGEN Adina	KAZ	31					
VAN BAAL Sjimie	NED						
KRONENTHAL Charlotte	GER	32					
FREILICH Lena	POL						

REPECHAGE

ZINK M. (GER)		61	KIELBASA N. (POL)	000 s2 / 001 s2 [04:00]	65	YUSIFLI S. (AZE)	100 s0 / 000 s0 [01:12]	69	BAILLEUL H. (FRA)	000 s0 / 100 s0 [02:44]
KIELBASA N. (POL)			YUSIFLI S. (AZE)	001 s1 / 020 s1 [02:39]		HIETANEN-LIN C. (FIN)	000 s0 / 111 s0 [01:48]		BAILLEUL H. (FRA)	000 s0 / 100 s0 [00:47]
KMITA L. (POL)		62	HIETANEN-LIN C. (FIN)	000 s0 / 000 s0 [01:33]	66	BARTYIK I. (HUN)	000 s0 / 100 s0 [00:47]	70	MEKAITON S. (ISR)	001 s1 / 011 s0 [05:01]
HIETANEN-LIN C. (FIN)			BARTYIK I. (HUN)	000 s0 / 100 s0 [01:33]		LOGONDER T. (SLO)	000 s1 / 001 s2 [04:00]		MEKAITON S. (ISR)	001 s1 / 011 s0 [05:01]
MALINOWSKA M. (POL)		63	LOGONDER T. (SLO)	000 s1 / 001 s2 [04:00]	67	SIMONIA L. (GEO)	000 s1 / 001 s2 [04:00]	71	CARAVELLO L. (AUS)	000 s0 / 101 s0 [01:31]
LOGONDER T. (SLO)			SIMONIA L. (GEO)	000 s1 / 001 s2 [04:00]		MITRAN A. (ROU)	000 s0 / 021 s0 [01:26]		CARAVELLO L. (AUS)	000 s0 / 101 s0 [01:31]
MITRAN A. (ROU)		64	MITRAN A. (ROU)	000 s2 / 010 s1 [04:00]	68	BAECHLE S. (GER)	000 s2 / 010 s1 [04:00]	72	PULJIC L. (CRO)	000 s1 / 002 s1 [04:00]
PALLAI D. (HUN)			BAECHLE S. (GER)	000 s2 / 010 s1 [04:00]		PULJIC L. (CRO)	000 s1 / 002 s1 [04:00]		PULJIC L. (CRO)	000 s1 / 002 s1 [04:00]

FINAL RESULTS

- CIUPEK Jagoda
- ZHUMAZHAN Inzhu
- CEPELAKOVA Lucie
- NARRAIN Katharina
- BAILLEUL Helea
- PULJIC Lucija
- CARAVELLO Lisa





Bielsko Biala Millennium Team Cadet European Cup 2026

Poland, Bielsko Biala, 16-17 May 2026

-63 kg

Women (56)

POOL A

ANDRICH Nina	SRB
VON LUTZ Sophia	AUT
KUSMIERSKA Zofia	POL
MATUSZEKOVA Petra	SVK
CHIRILA Annalisa Nicole	ROU
KULIKAUSKAITE Meida	LTU
NAGY Greta	HUN
GULBANI Tinatin	GEO
VAN SON Frederique	NED
LEWICKA Oliwia	POL
SNIEGORSKA Dominika	POL
REINHOLD Jolina	GER
MATOUSKOVA Valentyna	CZE
ALEKSIENKO Mariia	UKR

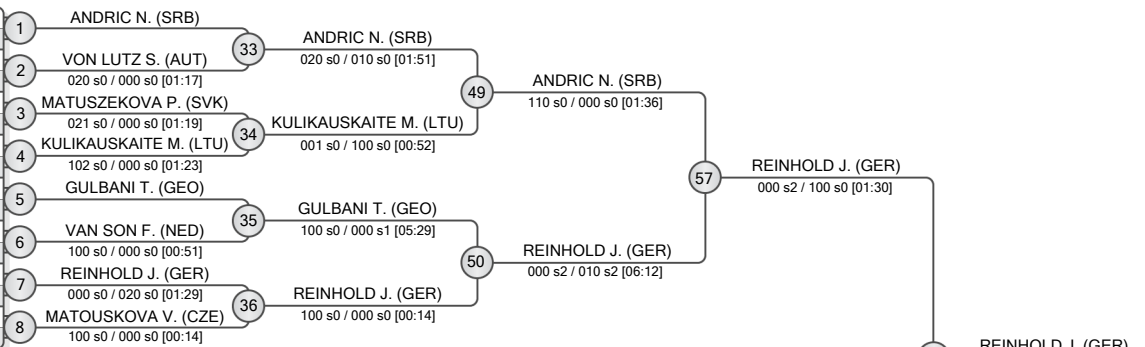

POOL B

SERIK Azima	KAZ
GRAFE Lene	GER
KRAWCZYK Lena	POL
HUSEYNLI Zilan	AZE
BESOLI PUJOL Jana	AND
KOPACZ Sarolta	ROU
JANISZEWSKI Maja	POL
KITUTELE Grace-Divine	FRA
STOCK Luisa	GER
SHADI Gaida	AUT
MALCZYNSKA Dominika	POL
SIMANIC Ana	BIH
JUSEVICIUTE Radvile	LTU
ZAREMBA Daria	UKR

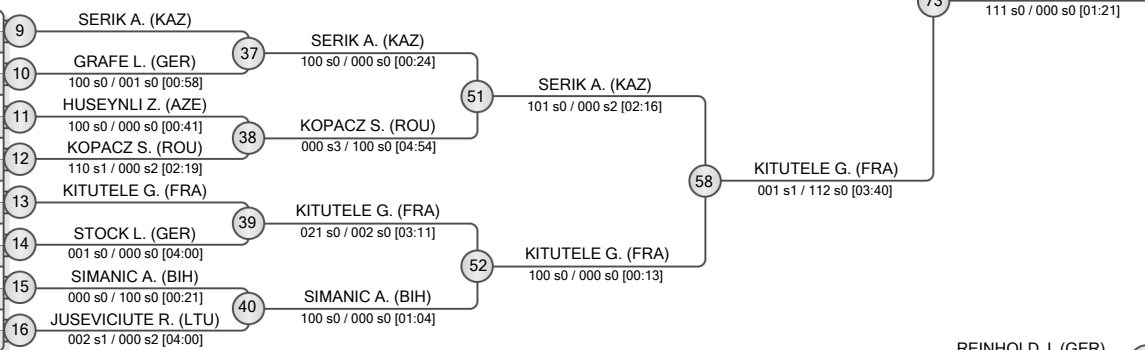

POOL C

MASHURENKO Arina	UKR
DZIOB Emilia	POL
AIDARKHAN Arailym	KAZ
DZIADKO Nadia	POL
STOJANOVIC Danica	SRB
BARONI Chiara	SUI
KAIN Kiara	AUT
FARKAS Zora	HUN
VALIYEVA Nazakat	AZE
ROEMMER Amelie	GER
KURICOVA Eva	CZE
SIMANSKAJA Viktorija	LTU
CIESZYNSKA Oliwia	POL
LE TOUZE Lou	FRA

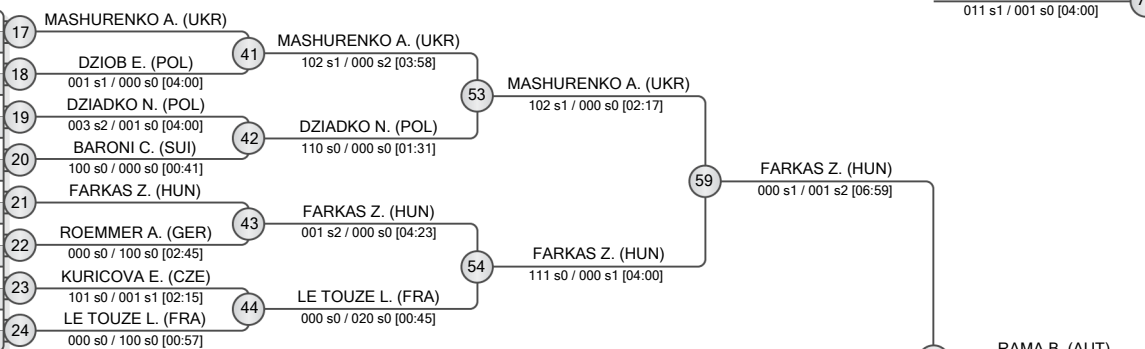

POOL D

RAMA Bleona	AUT
SPAHIC Seja	MNE
GRZECHNIK Hanna	POL
GLIGA Ana	ROU
LECHOWICZ Gabriela	POL
KOLOMIETS Valeriia	UKR
BUETTNER Antonia	GER
GALEWICZ Zoja	POL
SARIYEVA Assiya	KAZ
DANISOVA Ema	SVK
BANDI Synthia	HUN
OLESEK Nina	POL
ZAHHAROVA Anastasia	EST
JUSKAITE Eva	LTU

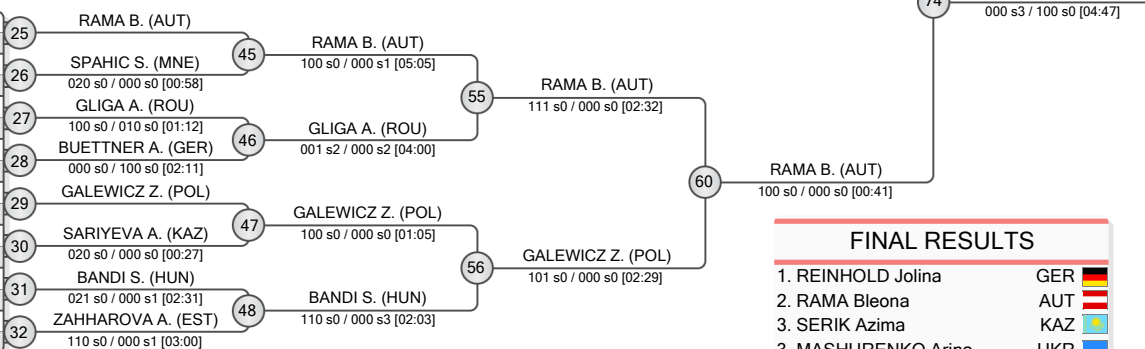

FINAL RESULTS		
1.	REINHOLD Jolina	GER
2.	RAMA Bleona	AUT
3.	SERIK Azima	KAZ
3.	MASHURENKO Arina	UKR
5.	FARKAS Zora	HUN
5.	KITUTELE Grace-Divine	FRA
7.	MATOUSKOVA Valentyna	CZE
7.	GALEWICZ Zoja	POL

REPECHAGE

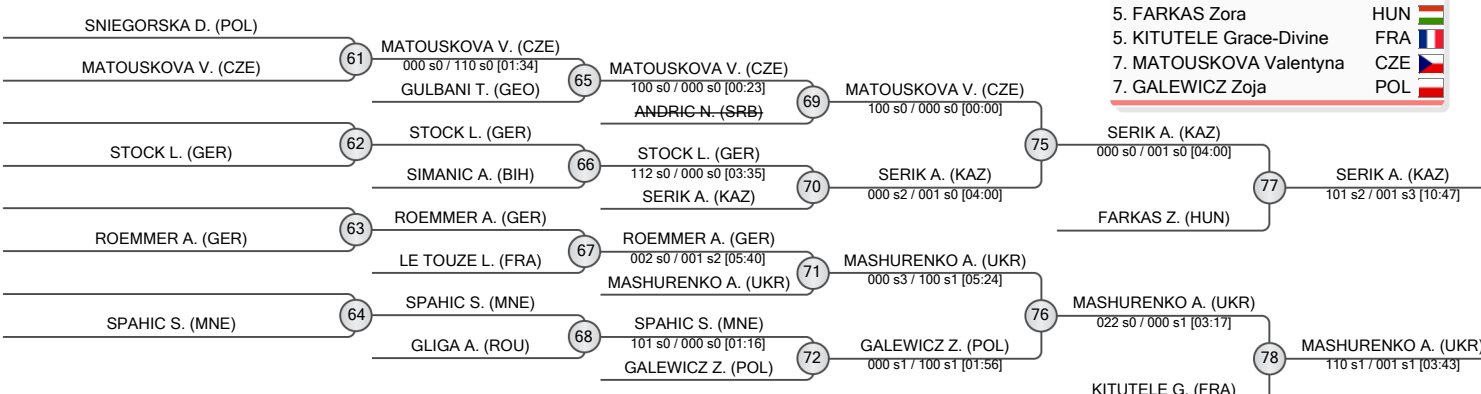



Bielsko Biala Millennium Team Cadet European Cup 2026

Poland, Bielsko Biala, 16-17 May 2026

-70 kg

Women (54)

POOL A

	WOEGERER Selina	AUT
	ANDRIUSKEVICIUTE Aukse	LTU
	MICHOR Milena	POL
	HVOLKOVA Hana	SVK
	MALCZAK Lara Katharina	GER
	BALLERING Fleur	NED
	WTULICH - PARGULSKA Antonina	POL
	ZIVANOVIC Tijana	SRB
	WATROBA Dominika	POL
	FUKSOVA Klara	CZE
	KUPRIKOVA Daryna	UKR
	KOVALENKO Karina	KAZ
	KOZIELEC Julia	POL
	ZELL Amit	ISR

1	WOEGERER S. (AUT)	33	WOEGERER S. (AUT)	
2	MICHOR M. (POL)	000 s0 / 100 s0 [00:59]	34	BALLERING F. (NED)
3	MALCZAK L. (GER)	000 s0 / 100 s0 [01:04]	35	ZIVANOVIC T. (SRB)
4	BALLERING F. (NED)	100 s0 / 000 s0 [00:20]	36	KOZIELEC J. (POL)
5	ZIVANOVIC T. (SRB)	020 s1 / 000 s0 [02:45]	37	TOMBOU V. (BEL)
6	WATROBA D. (POL)	021 s0 / 000 s0 [03:50]	38	ILIASOVA E. (SVK)
7	KUPRIKOVA D. (UKR)	010 s1 / 000 s1 [04:00]	39	GOSSET N. (FRA)
8	KOZIELEC J. (POL)	000 s0 / 101 s0 [01:57]	40	HANGYASI Z. (HUN)

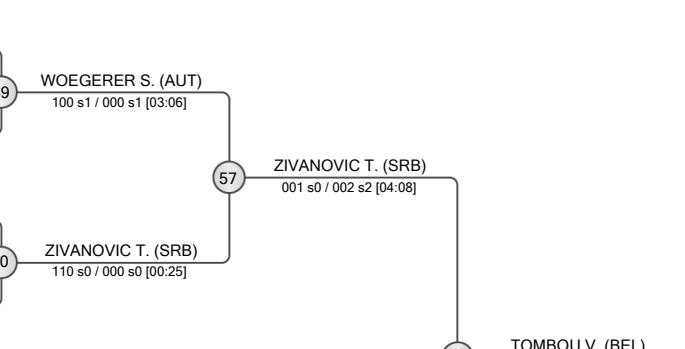

POOL B

	TOMBOU Valerie	BEL
	WEJER Ewa	POL
	SOPAITE Iruna	LTU
	ILIASOVA Emilia	SVK
	CIESLUK Zofia	POL
	LATKOWSKI Antonia	GER
	VENDRIG Esmee	NED
	HUDIKA Vita	CRO
	HEYKE Magda	POL
	GOSSET Norah	FRA
	TERLETSKA Anna	UKR
	HANGYASI Zengo	HUN
	OMACKOVA Amalie	CZE

9	TOMBOU V. (BEL)	37	TOMBOU V. (BEL)	
10	WEJER E. (POL)	100 s0 / 000 s0 [01:35]	38	ILIASOVA E. (SVK)
11	ILIASOVA E. (SVK)	100 s0 / 000 s0 [00:45]	39	GOSSET N. (FRA)
12	LATKOWSKI A. (GER)	011 s0 / 000 s0 [04:00]	40	HANGYASI Z. (HUN)
13	HUDIKA V. (CRO)	000 s0 / 100 s0 [00:41]	41	RAGAUSKAITE V. (LTU)
14	GOSSET N. (FRA)	000 s0 / 100 s0 [00:41]	42	KUCEROVA A. (CZE)
15	HANGYASI Z. (HUN)	000 s0 / 001 s1 [04:00]	43	FILZWIESER E. (AUT)
16	OMACKOVA A. (CZE)	001 s1 / 000 s2 [06:00]	44	GUIRAL E. (FRA)

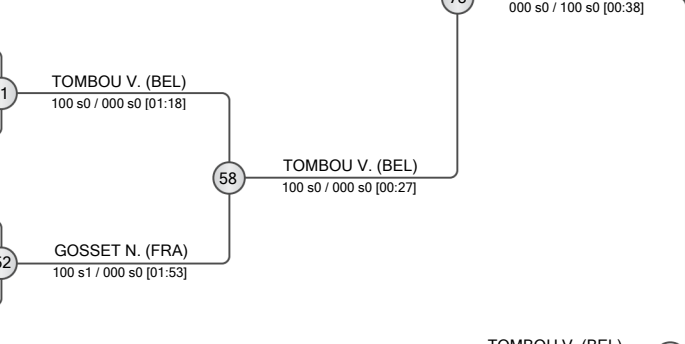

POOL C

	RAGAUSKAITE Viktorija	LTU
	ALBINOWSKA Patrycja	POL
	GABITOVA Sara	KAZ
	KUCEROVA Anna	CZE
	MAMMADLI Masuma	AZE
	KOCJAN Dagmara	POL
	SERBYN Viktorija	UKR
	FILZWIESER Emma	AUT
	POKLOPOVA Lucie	CZE
	DROBNJAK Mia	SRB
	WOJCIECH Zuzanna	POL
	PILZ Amelie Fabienne	GER
	LEHOTKAILOVA Zuzana	SVK
	GUIRAL Emma	FRA

17	RAGAUSKAITE V. (LTU)	41	RAGAUSKAITE V. (LTU)	
18	GABITOVA S. (KAZ)	000 s1 / 002 s2 [04:00]	42	KUCEROVA A. (CZE)
19	KUCEROVA A. (CZE)	100 s0 / 000 s3 [03:30]	43	FILZWIESER E. (AUT)
20	SERBYN V. (UKR)	000 s0 / 100 s0 [00:11]	44	GUIRAL E. (FRA)
21	FILZWIESER E. (AUT)	101 s0 / 000 s1 [03:45]	45	KARAFFOVA V. (CZE)
22	DROBNJAK M. (SRB)	000 s0 / 001 s2 [04:40]	46	GEOFFROY A. (FRA)
23	PILZ A. (GER)	002 s0 / 110 s0 [03:47]	47	SAMOILIU D. (UKR)
24	GUIRAL E. (FRA)	000 s0 / 100 s0 [01:11]	48	THIERY E. (GER)

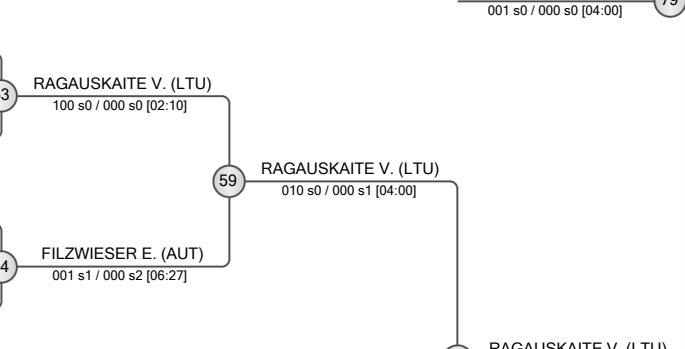

POOL D

	KARAFFOVA Vanessa	CZE
	KEDING Svenja	GER
	ALTAY Aisha	KAZ
	ZUIDWIJK Noel	NED
	PAWLAK Malgorzata	POL
	GEOFFROY Alexandra	FRA
	JONUSAITE Ieva	LTU
	SAMOILIU D. Diana	UKR
	RABL Nia	AUT
	GRUBBA Liwia	POL
	THIERY Emilie	GER
	JABLONSKA Maja	POL
	LEVADITI Pinelopi	GRE

25	KARAFFOVA V. (CZE)	45	KARAFFOVA V. (CZE)	
26	KEDING S. (GER)	001 s1 / 000 s1 [04:00]	46	GEOFFROY A. (FRA)
27	ZUIDWIJK N. (NED)	100 s1 / 000 s1 [03:35]	47	SAMOILIU D. (UKR)
28	GEOFFROY A. (FRA)	000 s2 / 101 s1 [03:03]	48	THIERY E. (GER)
29	SAMOILIU D. (UKR)	101 s0 / 000 s0 [02:16]	49	WATROBA D. (POL)
30	RABL N. (AUT)	100 s0 / 000 s0 [00:16]	50	ZIVANOVIC T. (SRB)
31	THIERY E. (GER)	102 s1 / 000 s1 [03:56]	51	TOMBOU V. (BEL)
32	LEVADITI P. (GRE)	110 s0 / 000 s0 [00:25]	52	GOSSET N. (FRA)

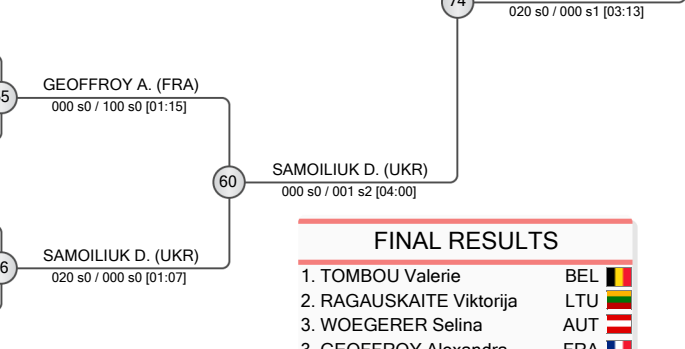

FINAL RESULTS		
1.	TOMBOU Valerie	BEL
2.	RAGAUSKAITE Viktorija	LTU
3.	WOEGERER Selina	AUT
3.	GEOFFROY Alexandra	FRA
5.	SAMOILIU Diana	UKR
5.	ZIVANOVIC Tijana	SRB
7.	GOSSET Norah	FRA
7.	FILZWIESER Emma	AUT

REPECHAGE

61	WATROBA D. (POL)	65	WATROBA D. (POL)
62	WEJER E. (POL)	66	ILIASOVA E. (SVK)
63	GABITOVA S. (KAZ)	67	GABITOVA S. (KAZ)
64	RABL N. (AUT)	68	THIERY E. (GER)

65	WATROBA D. (POL)	69	WOEGERER S. (AUT)
66	ILIASOVA E. (SVK)	70	GOSSET N. (FRA)
67	GABITOVA S. (KAZ)	71	FILZWIESER E. (AUT)
68	THIERY E. (GER)	72	GEOFFROY A. (FRA)

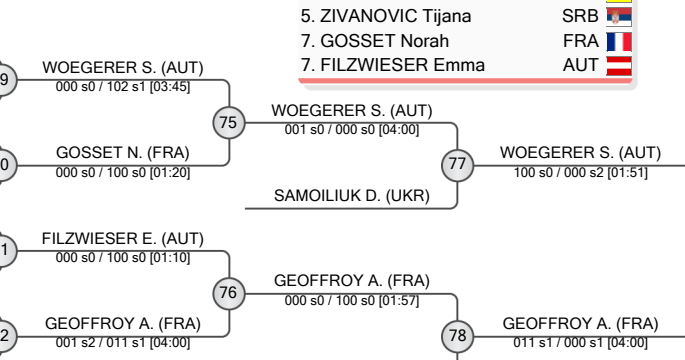



Bielsko Biala Millennium Team Cadet European Cup 2026

Poland, Bielsko Biala, 16-17 May 2026

+70 kg

Women (24)

POOL A

	TOLEBAY Togzhan	KAZ
	WANDJI Maelyne	FRA
	KOVALCHUK Anastasiia	UKR
	GABDULMANAP Nargiz	KAZ
	WOZNIAK Maria	POL
	VAN SUNDERT Fleur	NED

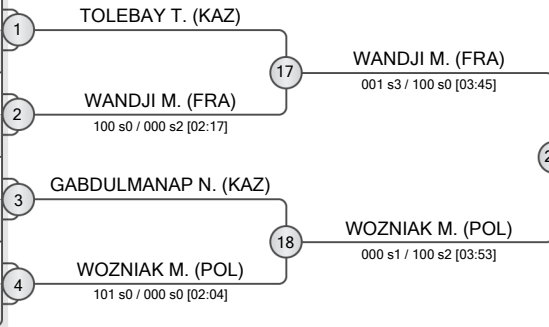

POOL B

	PAVIC Lucia	SRB
	MOROU Hidaya	GER
	NOWICKA Nikola	POL
	KAPIANIDZE Nia	GEO
	BLAWAT Jagoda	POL
	MARKET Stela	CRO

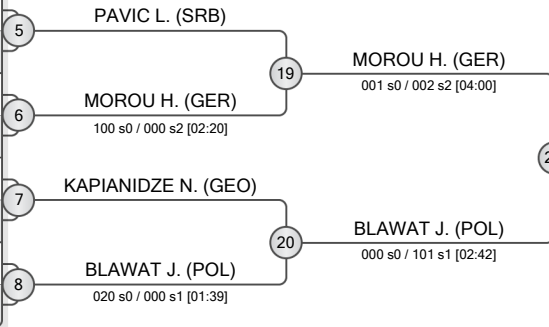

POOL C

	HOELLWART Michaela	AUT
	DOVHUN Yana	UKR
	JAROSZ Martyna	POL
	ALIYEVA Zemfira	AZE
	POZNANSKA Marta	POL
	VAN DRIEL Nova	NED

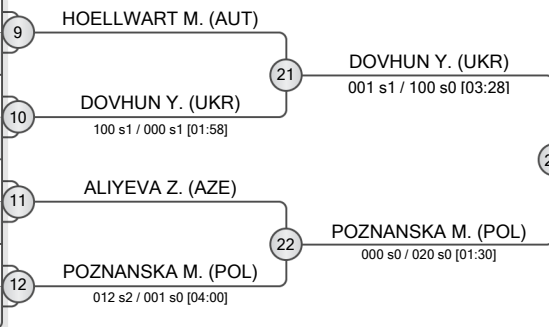

POOL D

	KHOLIIVKO Yana	UKR
	BERECKA Magdalena	CRO
	BAYANOVA Karlygash	KAZ
	GHVALADZE Maia	GEO
	KAYSER Zofia	POL
	CUBRILLO Tamara	SRB

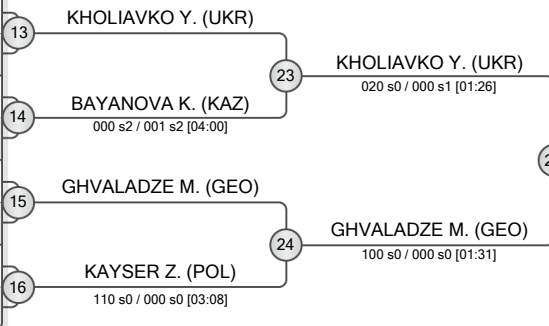

REPECHAGE

29	TOLEBAY T. (KAZ)	000 s3 / 100 s1 [02:47]
30	PAVIC L. (SRB)	000 s0 / 100 s1 [01:55]
31	HOELLWART M. (AUT)	001 s0 / 100 s0 [00:50]
32	BAYANOVA K. (KAZ)	

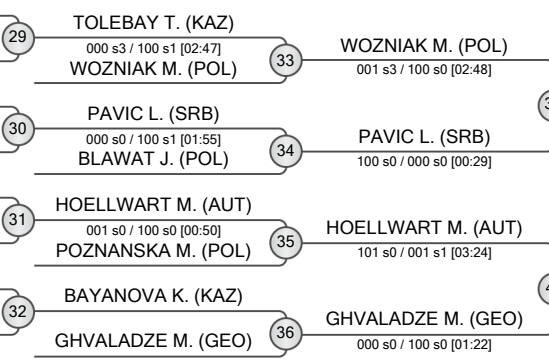

43 KHOLIIVKO Y. (UKR) 000 s2 / 020 s2 [03:12]

38 KHOLIIVKO Y. (UKR) 011 s2 / 110 s1 [03:42]

FINAL RESULTS	
1.	KHOLIIVKO Yana
2.	WANDJI Maelyne
3.	PAVIC Lucia
3.	HOELLWART Michaela
5.	DOVHUN Yana
5.	MOROU Hidaya
7.	WOZNIAK Maria
7.	GHVALADZE Maia

