



Quba Millennium Team Cadet European Cup 2025

Azerbaijan, Quba, 3-4 May 2025

-50 kg

Men (20)

POOL A

	GULIYEV Anar	AZE	1	GULIYEV A. (AZE)
	ALIYEV Ali	AZE	2	ALIYEV A. (AZE)
	RAUNAKH Duman	KAZ		101 s0 / 000 s0 [01:56]
	YUSIFZADA Yusif	AZE	3	YUSIFZADA Y. (AZE)
	IVANIUK Maksim	IJF	4	IVANIUK M. (IJF)

POOL B

	DAULETKAN Merey	KAZ	5	DAULETKAN M. (KAZ)
	HASANOV Ali	AZE	6	HASANOV A. (AZE)
	KHARIBEGASHVILI Daviti	GEO	7	KHARIBEGASHVILI D. (GEO)
	AYVAZLI Turan	AZE	8	AYVAZLI T. (AZE)
	MAHMUDOVS Devid	AZE		001 s2 / 000 s1 [07:48]

POOL C

	TALIBOV Ibrahim	AZE	9	TALIBOV I. (AZE)
	HOJADURDYEV Yunus	TKM	10	JAFAR I. (AZE)
	JAFAR Ismail	AZE		000 s1 / 100 s0 [02:24]
	HOFFMANN Andrea	FRA	11	HOFFMANN A. (FRA)
	IMANLI Ibrahim	AZE	12	IMANLI I. (AZE)

POOL D

	KHALILLI Rza	AZE	13	KHALILLI R. (AZE)
	TULENDIBAYEV Abay	KAZ	14	TULENDIBAYEV A. (KAZ)
	HUSEYNLI Huseyn	AZE		100 s0 / 000 s0 [00:00]
	STEKANOV Gleb	IJF	15	STEKANOV G. (IJF)
	ABUSHZADE Ravan	AZE	16	ABUSHZADE R. (AZE)

REPECHAGE

	ALIYEV A. (AZE)	29	ALIYEV A. (AZE)		33	ALIYEV A. (AZE)
			IVANIUK M. (IJF)			001 s2 / 000 s2 [09:03]
	HASANOV A. (AZE)	30	HASANOV A. (AZE)		34	HASANOV A. (AZE)
			KHARIBEGASHVILI D. (GEO)			100 s1 / 000 s1 [01:31]
	JAFAR I. (AZE)	31	JAFAR I. (AZE)		35	JAFAR I. (AZE)
			HOFFMANN A. (FRA)			100 s0 / 000 s1 [01:43]
	ABUSHZADE R. (AZE)	32	ABUSHZADE R. (AZE)		40	KHALILLI R. (AZE)
			KHALILLI R. (AZE)			000 s1 / 020 s1 [01:31]

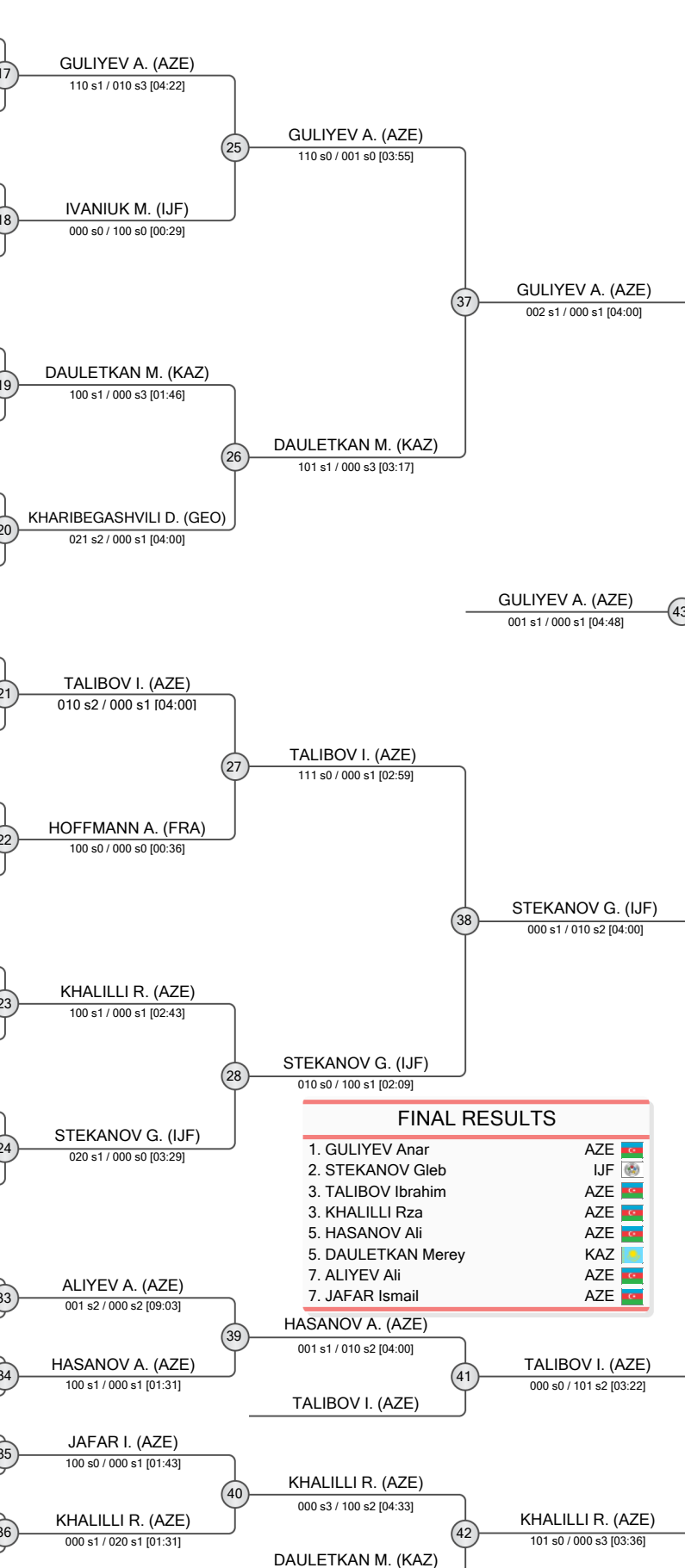

FINAL RESULTS

- GULIYEV Anar AZE
- STEKANOV Gleb IJF
- TALIBOV Ibrahim AZE
- KHALILLI Rza AZE
- HASANOV Ali AZE
- DAULETKAN Merey KAZ
- ALIYEV Ali AZE
- JAFAR Ismail AZE





Quba Millennium Team Cadet European Cup 2025

Azerbaijan, Quba, 3-4 May 2025

-55 kg

Men (35)

POOL A

1	MAMETOV Seitzhan	KAZ
2	HEYDAROV Heybat	AZE
3	SHIKHMAMMADOV Elgiz	AZE
4	MONTSIK Yauheni	IF1
5	ABDYLDAEV Sanzhar	KGZ
6	BAGHIROV Sabuhi	AZE
7	UNEZHEV Tamerlan	IJF
8	ASLANOV Alakbar	AZE

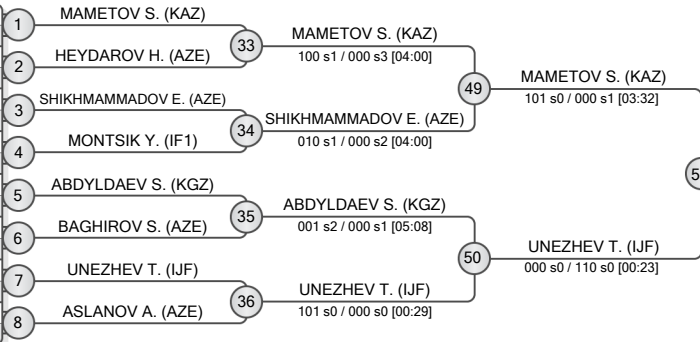

POOL B

9	TOPTYGIN Aleksei	IJF
10	GURBANALIYEV Rovshan	AZE
11	BAMAHFOUZ Eyad	KSA
12	CHITAIA Daviti	FRA
13	ATAKISHIYEV Aghahuseyn	AZE
14	GASIMZADE Rustam	AZE
15	BAHTIYAROV Ural	TKM
16	ISLAMLI Aykhan	AZE
17	GABIT Rassulkhan	KAZ

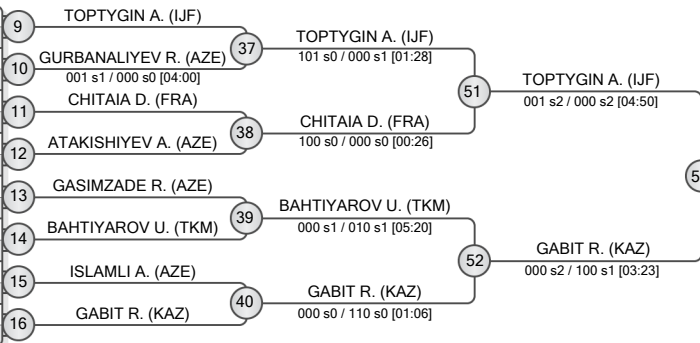

POOL C

17	ALIZADA Rasul	AZE
18	IUNUSOV Bahridin	KGZ
19	TEYMURLU Kanan	AZE
20	BABONETS Artem	IJF
21	MAINGOT Victor	FRA
22	AMANGELDY Beknur	KAZ
23	KHUDIYEV Farid	AZE
24	YAGSHYYEV Begench	TKM
25	KABIROV Murad	AZE

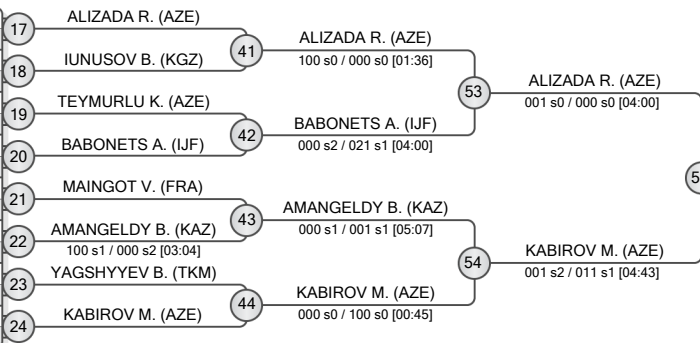

POOL D

25	HUSIYEV Mahammadali	AZE
26	KANDRATOVICH Hleb	IF1
27	TOPTYGIN Iliia	IJF
28	RUSTAMLI Mahammad	AZE
29	ALHARBI Moayad	KSA
30	MERKULOV Kirill	IJF
31	HUSEYNLI Jeyhun	AZE
32	ABDULLAYEV Ali	AZE
33	OMIRZHAN Zhalgas	KAZ

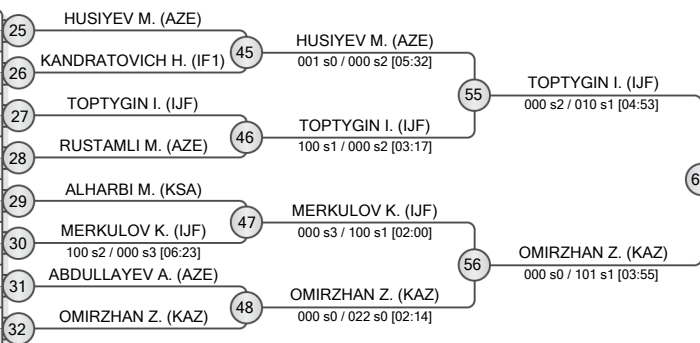

FINAL RESULTS		
1.	TOPTYGIN Aleksei	IJF
2.	ALIZADA Rasul	AZE
3.	TOPTYGIN Iliia	IJF
3.	UNEZHEV Tamerlan	IJF
5.	GABIT Rassulkhan	KAZ
5.	BABONETS Artem	IJF
7.	MAMETOV Seitzhan	KAZ
7.	RUSTAMLI Mahammad	AZE

REPECHAGE

61	ASLANOV A. (AZE)
62	GURBANALIYEV R. (AZE)
63	IUNUSOV B. (KGZ)
64	RUSTAMLI M. (AZE)

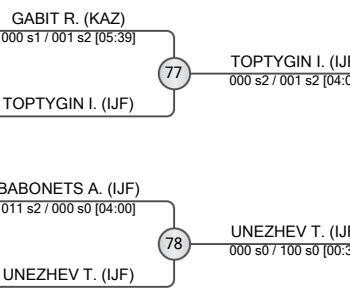
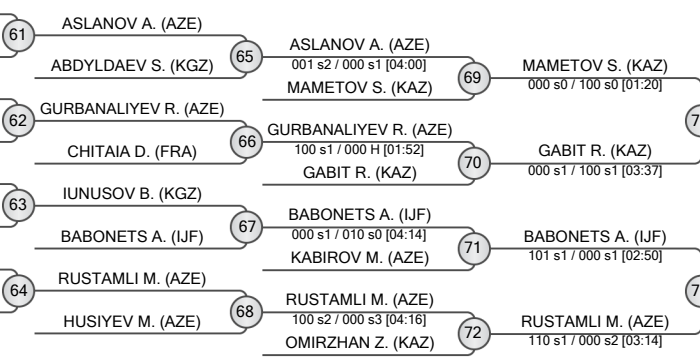



Quba Millennium Team Cadet European Cup 2025

Azerbaijan, Quba, 3-4 May 2025

-60 kg

Men (29)

POOL A

	ALASGAROV Zeyd	AZE
	BEKISHEV Bekdaulet	KAZ
	MAMMADOV Rza	AZE
	PIERROT Marius	FRA
	ASDANLI Dunyamali	AZE
	JAYTAKOV Jaytak	TKM
	ISAYEV Nemat	AZE

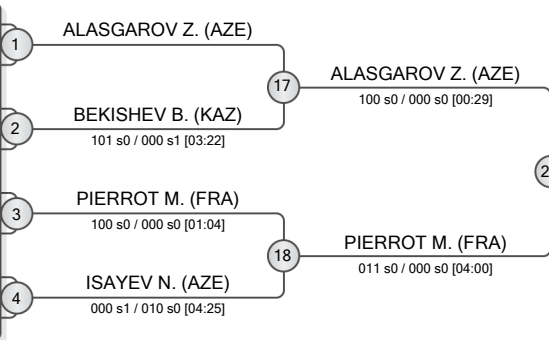

POOL B

	GARAYEV Ilkin	AZE
	RAMONOV David	IJF
	GANBARLI Sinan	AZE
	MOMYNTAY Tangzharyk	KAZ
	KAPANADZE Giorgi	GEO
	SHIKHIZADA Nijat	AZE
	BAGHIROV Zamaddin	AZE
	ABDYKASYMOV Baiel	KGZ

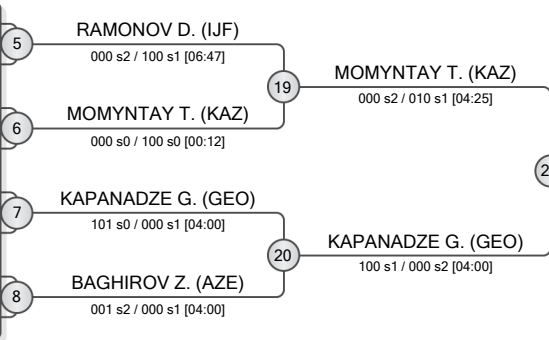

POOL C

	GAYIBOV Royal	AZE
	GIVISHVILI Nikolozi	GEO
	ZEYNALLI Ilham	AZE
	YELUBAYEV Yeran	KAZ
	HUSEYNLI Emil	AZE
	ALIZADA Tahir	AZE
	KUZNETSOV Roman	IF1

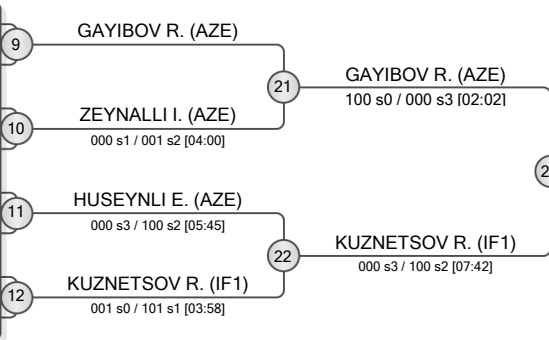

POOL D

	DARISPANASHVILI Luka	GEO
	SULTANOV Harun	AZE
	ABAY Zhanadil	KAZ
	TERENCEV Matvei	IJF
	ABADZADA Matin	AZE
	GULMAMMADOV Teymur	AZE
	GAYRADOV Muhammet	TKM

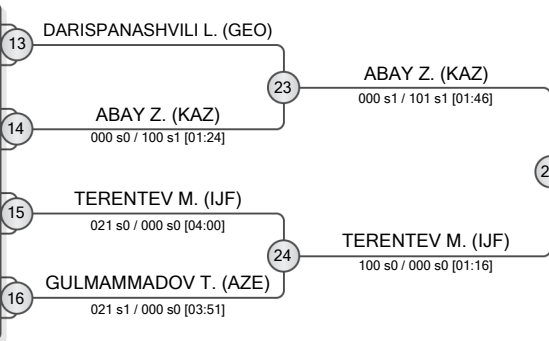

REPECHAGE

	BEKISHEV B. (KAZ)	29
	SHIKHIZADA N. (AZE)	30
	BAGHIROV Z. (AZE)	30
	ZEYNALLI I. (AZE)	31
	ABADZADA M. (AZE)	32
	GULMAMMADOV T. (AZE)	32

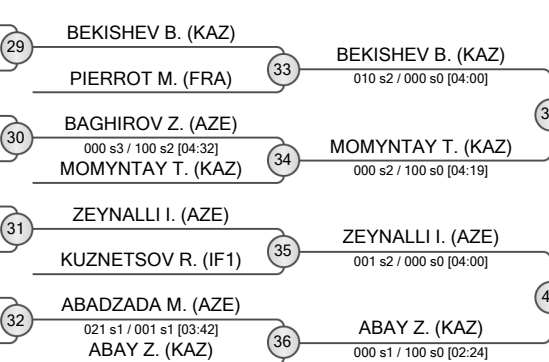

FINAL RESULTS		
1.	ALASGAROV Zeyd	AZE
2.	TERENCEV Matvei	IJF
3.	GAYIBOV Royal	AZE
3.	KAPANADZE Giorgi	GEO
5.	MOMYNTAY Tangzharyk	KAZ
5.	ZEYNALLI Ilham	AZE
7.	BEKISHEV Bekdaulet	KAZ
7.	ABAY Zhanadil	KAZ





Quba Millennium Team Cadet European Cup 2025

Azerbaijan, Quba, 3-4 May 2025

-66 kg

Men (38)

POOL A

	HUMBATOV Ali	AZE	1	HUMBATOV A. (AZE)	
	GBINGBEHI Nathan	FRA	2	GBINGBEHI N. (FRA)	33
	AKPAROV Rajab	AZE	3	BREGVADZE N. (GEO)	
	BREGVADZE Nika	GEO		000 s0 / 100 s0 [00:43]	
	ALAKBAROV Aykhan	AZE	4	ALAKBAROV A. (AZE)	34
	ABBASOV Yusif	AZE	5	ABBASOV Y. (AZE)	
	KEDELASHVILI Koba	GEO	6	KEDELASHVILI K. (GEO)	35
	JAFAROV Ali	AZE	7	AMANSAHEDOV U. (TKM)	
	AMANSAHEDOV Ulaman	TKM		000 s0 / 100 s0 [06:11]	
	KOTIEV Muslim	IJF	8	KOTIEV M. (IJF)	36
				000 s0 / 011 s0 [04:00]	

POOL B

	NIBO Tamerlan	IJF	9	NIBO T. (IJF)	
	MAMMADOV Kanan	AZE	10	MAMMADOV K. (AZE)	37
	ALMEHMADI Ahmed	KSA	11	ALMEHMADI A. (KSA)	
	ALIYEV Nijat	AZE	12	ALIYEV N. (AZE)	38
	KEKVIASHVILI Gigi	GEO	13	KEKVIASHVILI G. (GEO)	
	RZAYEV Ramazan	AZE	14	KUANYSHKALI I. (KAZ)	
	KUANYSHKALI Islam	KAZ		000 s2 / 010 s1 [04:43]	
	KHAMIYEV Sanan	AZE	15	KHAMIYEV S. (AZE)	
	HAJIYEV Alimohsun	AZE	16	HAJIYEV A. (AZE)	40
				000 s2 / 100 s2 [05:29]	

POOL C

	KHAMKHOEV Rakhim	IJF	17	KHAMKHOEV R. (IJF)	
	ABDULOV Umid	AZE	18	ABDULOV U. (AZE)	41
	HUSEYNOV Huseyn	AZE	19	HUSEYNOV H. (AZE)	
	SARKAROV Khayal	AZE	20	SARKAROV K. (AZE)	42
	TABET Ishak	FRA	21	TABET I. (FRA)	
	JOGERDISHVILI Nikoloz	GEO	22	JOGERDISHVILI N. (GEO)	43
	ABDULLAYEV Sadig	AZE		011 s1 / 000 s2 [04:00]	
	YERKEN Bekali	KAZ	23	YERKEN B. (KAZ)	
	PIRIYEV Sanan	AZE	24	PIRIYEV S. (AZE)	44
				001 s3 / 100 s0 [03:46]	

POOL D

	SAHIBZADE Fakhri	AZE	25	SAHIBZADE F. (AZE)	
	ABDRAIMOV Narmatbek	KGZ	26	CHOKGAYEV R. (TKM)	45
	CHOKGAYEV Rahman	TKM		000 s0 / 002 s0 [04:00]	
	TOTOSHVILI Giorgi	GEO	27	TOTOSHVILI G. (GEO)	
	HASANLI Farid	AZE	28	HASANLI F. (AZE)	46
	GULIYEV Ozgan	AZE	29	GULIYEV O. (AZE)	
	MAMMADOV Sadig	AZE	30	MAMMADOV S. (AZE)	47
	DUISSENBAY Nurdaulet	KAZ	31	DUISSENBAY N. (KAZ)	
	NASRULLAYEV Najaf	AZE		100 s1 / 001 s0 [02:04]	
	IDARMACHEV Daniial	IJF	32	IDARMACHEV D. (IJF)	48
				000 s0 / 020 s1 [03:10]	

REPECHAGE

	AMANSAHEDOV U. (TKM)	61	AMANSAHEDOV U. (TKM)	65	AMANSAHEDOV U. (TKM)	69	AMANSAHEDOV U. (TKM)	75	AMANSAHEDOV U. (TKM)	77	HUSEYNOV H. (AZE)
			ABBASOV Y. (AZE)		ALAKBAROV A. (AZE)		010 s2 / 000 s1 [04:00]		011 s1 / 000 s1 [04:00]		000 s1 / 100 s0 [01:57]
	MAMMADOV K. (AZE)	62	MAMMADOV K. (AZE)	66	MAMMADOV K. (AZE)	70	MAMMADOV K. (AZE)	76	MAMMADOV K. (AZE)	78	NIBO T. (IJF)
			ALIYEV N. (AZE)		KEKVIASHVILI G. (GEO)		110 s0 / 000 s0 [01:21]		100 s1 / 010 s3 [03:57]		000 s0 / 100 s0 [00:45]
	SARKAROV K. (AZE)	63	SARKAROV K. (AZE)	67	KHAMKHOEV R. (IJF)	71	KHAMKHOEV R. (IJF)	77	KHAMKHOEV R. (IJF)	78	NIBO T. (IJF)
					TABET I. (FRA)		000 s2 / 011 s0 [04:00]		010 s0 / 000 s1 [04:00]		
	CHOKGAYEV R. (TKM)	64	CHOKGAYEV R. (TKM)	68	TOTOSHVILI G. (GEO)	72	GULIYEV O. (AZE)	78	GULIYEV O. (AZE)	78	NIBO T. (IJF)
					TOTOSHVILI G. (GEO)		001 s0 / 021 s0 [01:01]		000 s0 / 020 s0 [01:06]		

FINAL RESULTS		
1.	KOTIEV Muslim	IJF
2.	SAHIBZADE Fakhri	AZE
3.	HUSEYNOV Huseyn	AZE
3.	NIBO Tamerlan	IJF
5.	AMANSAHEDOV Ulaman	TKM
5.	KHAMKHOEV Rakhim	IJF
7.	MAMMADOV Kanan	AZE
7.	GULIYEV Ozgan	AZE





Quba Millennium Team Cadet European Cup 2025

Azerbaijan, Quba, 3-4 May 2025

-73 kg

Men (27)

POOL A

	HASANLI Aykhan	AZE
	TAGANOV Bayram	TKM
	GERAULT Pierick	FRA
	SAMSIANI Ieso	GEO
	KANBAROV Hikmet	AZE
	BIIBOLATOV Daniial	IJF
	NAZAR Yusuf	AZE

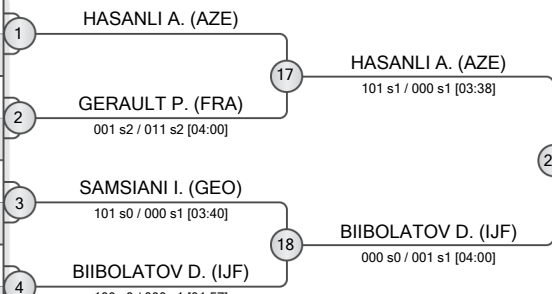

POOL B

	BORZECKI Jakub	POL
	ATAYEV Omar	AZE
	ASADLI Imran	AZE
	BICHOEV Atkhan	IJF
	ZULFUGAROV Nihat	AZE
	ZHUMABAY Adil	KAZ

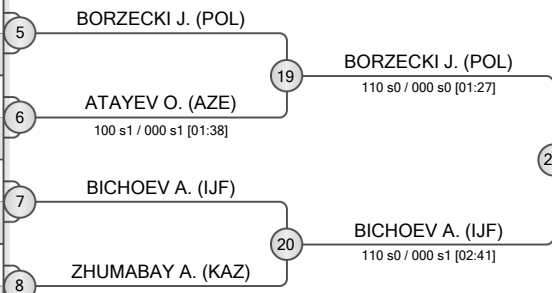

POOL C

	SHARIFOV Said	AZE
	IBRAHIMZADA Yunis	AZE
	KVITSIANI Nikoloz	GEO
	HAMDAOUI Ahmed-Adam	FRA
	ABDULLAYEV Natig	AZE
	MAMMADOV Yagub	AZE
	SHAMDAULET Alinur	KAZ

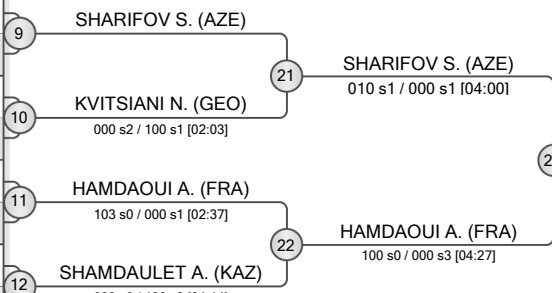

POOL D

	AGHAKISHIYEV Mahammad	AZE
	ALEINIKOV Alexandr	IF1
	IMERLISHVILI Luka	GEO
	BASHKAEV Al-Malik	IJF
	MUSAYEV Aydin	AZE
	MAMMADLI Akif	AZE
	ZHUMABAY Margulan	KAZ

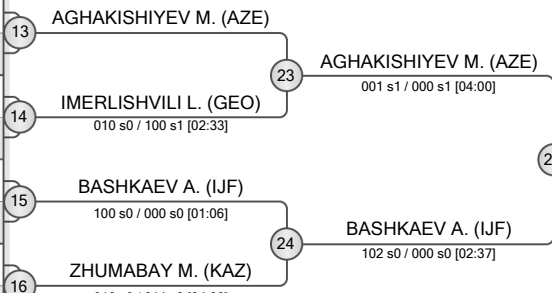

REPECHAGE

NAZAR Y. (AZE)	29	SAMSIANI I. (GEO)	30	ZHUMABAY A. (KAZ)	31	KVITSIANI N. (GEO)	32	ZHUMABAY M. (KAZ)
SAMSIANI I. (GEO)	33	HASANLI A. (AZE)	34	BORZECKI J. (POL)	35	HAMDAOUI A. (FRA)	36	AGHAKISHIYEV M. (AZE)
ZHUMABAY A. (KAZ)	39	SAMSIANI I. (GEO)	40	AGHAKISHIYEV M. (AZE)	41	SAMSIANI I. (GEO)	42	AGHAKISHIYEV M. (AZE)
BORZECKI J. (POL)	41	SAMSIANI I. (GEO)	42	AGHAKISHIYEV M. (AZE)	43	BICHOEV A. (IJF)	43	BICHOEV A. (IJF)
KVITSIANI N. (GEO)	43	BICHOEV A. (IJF)	44	BICHOEV A. (IJF)	45	BICHOEV A. (IJF)	46	BICHOEV A. (IJF)
MUSAYEV A. (AZE)	45	BICHOEV A. (IJF)	46	BICHOEV A. (IJF)	47	BICHOEV A. (IJF)	48	BICHOEV A. (IJF)
ZHUMABAY M. (KAZ)	47	BICHOEV A. (IJF)	48	BICHOEV A. (IJF)	49	BICHOEV A. (IJF)	50	BICHOEV A. (IJF)
AGHAKISHIYEV M. (AZE)	49	BICHOEV A. (IJF)	50	BICHOEV A. (IJF)	51	BICHOEV A. (IJF)	52	BICHOEV A. (IJF)
AGHAKISHIYEV M. (AZE)	51	BICHOEV A. (IJF)	52	BICHOEV A. (IJF)	53	BICHOEV A. (IJF)	54	BICHOEV A. (IJF)
AGHAKISHIYEV M. (AZE)	53	BICHOEV A. (IJF)	54	BICHOEV A. (IJF)	55	BICHOEV A. (IJF)	56	BICHOEV A. (IJF)
AGHAKISHIYEV M. (AZE)	55	BICHOEV A. (IJF)	56	BICHOEV A. (IJF)	57	BICHOEV A. (IJF)	58	BICHOEV A. (IJF)
AGHAKISHIYEV M. (AZE)	57	BICHOEV A. (IJF)	58	BICHOEV A. (IJF)	59	BICHOEV A. (IJF)	60	BICHOEV A. (IJF)
AGHAKISHIYEV M. (AZE)	59	BICHOEV A. (IJF)	60	BICHOEV A. (IJF)	61	BICHOEV A. (IJF)	62	BICHOEV A. (IJF)
AGHAKISHIYEV M. (AZE)	61	BICHOEV A. (IJF)	62	BICHOEV A. (IJF)	63	BICHOEV A. (IJF)	64	BICHOEV A. (IJF)
AGHAKISHIYEV M. (AZE)	63	BICHOEV A. (IJF)	64	BICHOEV A. (IJF)	65	BICHOEV A. (IJF)	66	BICHOEV A. (IJF)
AGHAKISHIYEV M. (AZE)	65	BICHOEV A. (IJF)	66	BICHOEV A. (IJF)	67	BICHOEV A. (IJF)	68	BICHOEV A. (IJF)
AGHAKISHIYEV M. (AZE)	67	BICHOEV A. (IJF)	68	BICHOEV A. (IJF)	69	BICHOEV A. (IJF)	70	BICHOEV A. (IJF)
AGHAKISHIYEV M. (AZE)	69	BICHOEV A. (IJF)	70	BICHOEV A. (IJF)	71	BICHOEV A. (IJF)	72	BICHOEV A. (IJF)
AGHAKISHIYEV M. (AZE)	71	BICHOEV A. (IJF)	72	BICHOEV A. (IJF)	73	BICHOEV A. (IJF)	74	BICHOEV A. (IJF)
AGHAKISHIYEV M. (AZE)	73	BICHOEV A. (IJF)	74	BICHOEV A. (IJF)	75	BICHOEV A. (IJF)	76	BICHOEV A. (IJF)
AGHAKISHIYEV M. (AZE)	75	BICHOEV A. (IJF)	76	BICHOEV A. (IJF)	77	BICHOEV A. (IJF)	78	BICHOEV A. (IJF)
AGHAKISHIYEV M. (AZE)	77	BICHOEV A. (IJF)	78	BICHOEV A. (IJF)	79	BICHOEV A. (IJF)	80	BICHOEV A. (IJF)
AGHAKISHIYEV M. (AZE)	79	BICHOEV A. (IJF)	80	BICHOEV A. (IJF)	81	BICHOEV A. (IJF)	82	BICHOEV A. (IJF)
AGHAKISHIYEV M. (AZE)	81	BICHOEV A. (IJF)	82	BICHOEV A. (IJF)	83	BICHOEV A. (IJF)	84	BICHOEV A. (IJF)
AGHAKISHIYEV M. (AZE)	83	BICHOEV A. (IJF)	84	BICHOEV A. (IJF)	85	BICHOEV A. (IJF)	86	BICHOEV A. (IJF)
AGHAKISHIYEV M. (AZE)	85	BICHOEV A. (IJF)	86	BICHOEV A. (IJF)	87	BICHOEV A. (IJF)	88	BICHOEV A. (IJF)
AGHAKISHIYEV M. (AZE)	87	BICHOEV A. (IJF)	88	BICHOEV A. (IJF)	89	BICHOEV A. (IJF)	90	BICHOEV A. (IJF)
AGHAKISHIYEV M. (AZE)	89	BICHOEV A. (IJF)	90	BICHOEV A. (IJF)	91	BICHOEV A. (IJF)	92	BICHOEV A. (IJF)
AGHAKISHIYEV M. (AZE)	91	BICHOEV A. (IJF)	92	BICHOEV A. (IJF)	93	BICHOEV A. (IJF)	94	BICHOEV A. (IJF)
AGHAKISHIYEV M. (AZE)	93	BICHOEV A. (IJF)	94	BICHOEV A. (IJF)	95	BICHOEV A. (IJF)	96	BICHOEV A. (IJF)
AGHAKISHIYEV M. (AZE)	95	BICHOEV A. (IJF)	96	BICHOEV A. (IJF)	97	BICHOEV A. (IJF)	98	BICHOEV A. (IJF)
AGHAKISHIYEV M. (AZE)	97	BICHOEV A. (IJF)	98	BICHOEV A. (IJF)	99	BICHOEV A. (IJF)	100	BICHOEV A. (IJF)
AGHAKISHIYEV M. (AZE)	99	BICHOEV A. (IJF)	100	BICHOEV A. (IJF)	101	BICHOEV A. (IJF)	102	BICHOEV A. (IJF)
AGHAKISHIYEV M. (AZE)	101	BICHOEV A. (IJF)	102	BICHOEV A. (IJF)	103	BICHOEV A. (IJF)	104	BICHOEV A. (IJF)
AGHAKISHIYEV M. (AZE)	103	BICHOEV A. (IJF)	104	BICHOEV A. (IJF)	105	BICHOEV A. (IJF)	106	BICHOEV A. (IJF)
AGHAKISHIYEV M. (AZE)	105	BICHOEV A. (IJF)	106	BICHOEV A. (IJF)	107	BICHOEV A. (IJF)	108	BICHOEV A. (IJF)
AGHAKISHIYEV M. (AZE)	107	BICHOEV A. (IJF)	108	BICHOEV A. (IJF)	109	BICHOEV A. (IJF)	110	BICHOEV A. (IJF)
AGHAKISHIYEV M. (AZE)	109	BICHOEV A. (IJF)	110	BICHOEV A. (IJF)	111	BICHOEV A. (IJF)	112	BICHOEV A. (IJF)
AGHAKISHIYEV M. (AZE)	111	BICHOEV A. (IJF)	112	BICHOEV A. (IJF)	113	BICHOEV A. (IJF)	114	BICHOEV A. (IJF)
AGHAKISHIYEV M. (AZE)	113	BICHOEV A. (IJF)	114	BICHOEV A. (IJF)	115	BICHOEV A. (IJF)	116	BICHOEV A. (IJF)
AGHAKISHIYEV M. (AZE)	115	BICHOEV A. (IJF)	116	BICHOEV A. (IJF)	117	BICHOEV A. (IJF)	118	BICHOEV A. (IJF)
AGHAKISHIYEV M. (AZE)	117	BICHOEV A. (IJF)	118	BICHOEV A. (IJF)	119	BICHOEV A. (IJF)	120	BICHOEV A. (IJF)
AGHAKISHIYEV M. (AZE)	119	BICHOEV A. (IJF)	120	BICHOEV A. (IJF)	121	BICHOEV A. (IJF)	122	BICHOEV A. (IJF)
AGHAKISHIYEV M. (AZE)	121	BICHOEV A. (IJF)	122	BICHOEV A. (IJF)	123	BICHOEV A. (IJF)	124	BICHOEV A. (IJF)
AGHAKISHIYEV M. (AZE)	123	BICHOEV A. (IJF)	124	BICHOEV A. (IJF)	125	BICHOEV A. (IJF)	126	BICHOEV A. (IJF)
AGHAKISHIYEV M. (AZE)	125	BICHOEV A. (IJF)	126	BICHOEV A. (IJF)	127	BICHOEV A. (IJF)	128	BICHOEV A. (IJF)
AGHAKISHIYEV M. (AZE)	127	BICHOEV A. (IJF)	128	BICHOEV A. (IJF)	129	BICHOEV A. (IJF)	130	BICHOEV A. (IJF)
AGHAKISHIYEV M. (AZE)	129	BICHOEV A. (IJF)	130	BICHOEV A. (IJF)	131	BICHOEV A. (IJF)	132	BICHOEV A. (IJF)
AGHAKISHIYEV M. (AZE)	131	BICHOEV A. (IJF)	132	BICHOEV A. (IJF)	133	BICHOEV A. (IJF)	134	BICHOEV A. (IJF)
AGHAKISHIYEV M. (AZE)	133	BICHOEV A. (IJF)	134	BICHOEV A. (IJF)	135	BICHOEV A. (IJF)	136	BICHOEV A. (IJF)
AGHAKISHIYEV M. (AZE)	135	BICHOEV A. (IJF)	136	BICHOEV A. (IJF)	137	BICHOEV A. (IJF)	138	BICHOEV A. (IJF)
AGHAKISHIYEV M. (AZE)	137	BICHOEV A. (IJF)	138	BICHOEV A. (IJF)	139	BICHOEV A. (IJF)	140	BICHOEV A. (IJF)
AGHAKISHIYEV M. (AZE)	139	BICHOEV A. (IJF)	140	BICHOEV A. (IJF)	141	BICHOEV A. (IJF)	142	BICHOEV A. (IJF)
AGHAKISHIYEV M. (AZE)	141	BICHOEV A. (IJF)	142	BICHOEV A. (IJF)	143	BICHOEV A. (IJF)	144	BICHOEV A. (IJF)
AGHAKISHIYEV M. (AZE)	143	BICHOEV A. (IJF)	144	BICHOEV A. (IJF)	145	BICHOEV A. (IJF)	146	BICHOEV A. (IJF)
AGHAKISHIYEV M. (AZE)	145	BICHOEV A. (IJF)	146	BICHOEV A. (IJF)	147	BICHOEV A. (IJF)	148	BICHOEV A. (IJF)
AGHAKISHIYEV M. (AZE)	147	BICHOEV A. (IJF)	148	BICHOEV A. (IJF)	149	BICHOEV A. (IJF)	150	BICHOEV A. (IJF)
AGHAKISHIYEV M. (AZE)	149	BICHOEV A. (IJF)	150	BICHOEV A. (IJF)	151	BICHOEV A. (IJF)	152	BICHOEV A. (IJF)
AGHAKISHIYEV M. (AZE)	151	BICHOEV A. (IJF)	152	BICHOEV A. (IJF)	153	BICHOEV A. (IJF)	154	BICHOEV A. (IJF)
AGHAKISHIYEV M. (AZE)	153	BICHOEV A. (IJF)	154	BICHOEV A. (IJF)	155	BICHOEV A. (IJF)	156	BICHOEV A. (IJF)
AGHAKISHIYEV M. (AZE)	155	BICHOEV A. (IJF)	156	BICHOEV A. (IJF)	157	BICHOEV A. (IJF)	158	BICHOEV A. (IJF)
AGHAKISHIYEV M. (AZE)	157	BICHOEV A. (IJF)	158	BICHOEV A. (IJF)	159	BICHOEV A. (IJF)	160	BICHOEV A. (IJF)
AGHAKISHIYEV M. (AZE)	159	BICHOEV A. (IJF)	160	BICHOEV A. (IJF)	161	BICHOEV A. (IJF)	162	BICHOEV A. (IJF)
AGHAKISHIYEV M. (AZE)	161	BICHOEV A. (IJF)	162	BICHOEV A. (IJF)	163	BICHOEV A. (IJF)	164	BICHOEV A. (IJF)
AGHAKISHIYEV M. (AZE)	163	BICHOEV A. (IJF)	164	BICHOEV A. (IJF)	165	BICHOEV A. (IJF)	166	BICHOEV A. (IJF)
AGHAKISHIYEV M. (AZE)	165	BICHOEV A. (IJF)	166	BICHOEV A. (IJF)	167	BICHOEV A. (IJF)	168	BICHOEV A. (IJF)
AGHAKISHIYEV M. (AZE)	167	BICHOEV A. (IJF)	168	BICHOEV A. (IJF)	169	BICHOEV A. (IJF)	170	BICHOEV A. (IJF)
AGHAKISHIYEV M. (AZE)	169	BICHOEV A. (IJF)	170	BICHOEV A. (IJF)	171	BICHOEV A. (IJF)	172	BICHOEV A. (IJF)
AGHAKISHIYEV M. (AZE)	171	BICHOEV A. (IJF)	172	BICHOEV A. (IJF)	173	BICHOEV A. (IJF)	174	BICHOEV A. (IJF)
AGHAKISHIYEV M. (AZE)	173	BICHOEV A. (IJF)	174	BICHOEV A. (IJF)	175	BICHOEV A. (IJF)	176	BICHOEV A. (IJF)
AGHAKISHIYEV M. (AZE)	175	BICHOEV A. (IJF)	176	BICHOEV A. (IJF)	177	BICHOEV A. (IJF)	178	BICHOEV A. (IJF)
AGHAKISHIYEV M. (AZE)	177	BICHOEV A. (IJF)	178	BICHOEV A. (IJF)	179	BICHOEV A. (IJF)	180	BICHOEV A. (IJF)
AGHAKISHIYEV M. (AZE)	179	BICHOEV A. (IJF)	180	BICHOEV A. (IJF)	181	BICHOEV A. (IJF)	182	BICHOEV A. (IJF)
AGHAKISHIYEV M. (AZE)	181	BICHOEV A. (IJF)	182	BICHOEV A. (IJF)	183	BICHOEV A. (IJF)	184	BICHOEV A. (IJF)
AGHAKISHIYEV M. (AZE)	183	BICHOEV A. (IJF)	184	BICHOEV A. (IJF)	185	BICHOEV A. (IJF)	186	BICHOEV A. (IJF)
AGHAKISHIYEV M. (AZE)	185	BICHOEV A. (IJF)	186	BICHOEV A. (IJF)	187	BICHOEV A. (IJF)	188	BICHOEV A. (IJF)
AGHAKISHIYEV M. (AZE)	187	BICHOEV A. (IJF)	188	BICHOEV A. (IJF)	189	BICHOEV A. (IJF)	190	BICHOEV A. (IJF)
AGHAKISHIYEV M. (AZE)	189	BICHOEV A. (IJF)	190	BICHOEV A. (IJF)	191	BICHOEV A. (IJF)	192	BICHOEV A. (IJF)
AGHAKISHIYEV M. (AZE)	191	BICHOEV A. (IJF)	192	BICHOEV A. (IJF)	193	BICHOEV A. (IJF)	194	BICHOEV A. (IJF)
AGHAKISHIYEV M. (AZE)	193	BICHOEV A. (IJF)	194	BICHOEV A. (IJF)	195	BICHOEV A. (IJF)	196	BICHOEV A. (IJF)
AGHAKISHIYEV M. (AZE)	195	BICHOEV A. (IJF)	196	BICHOEV A. (IJF)	197	BICHOEV A. (IJF)	198	BICHOEV A. (IJF)
AGHAKISHIYEV M. (AZE)	197	BICHOEV A. (IJF)	198	BICHOEV A. (IJF)	199	BICHOEV A. (IJF)	200	BICHOEV A. (IJF)
AGHAKISHIYEV M. (AZE)	199	BICHOEV A. (IJF)	200	BICHOEV A. (IJF)	201	BICHOEV A. (IJF)	202	BICHOEV A. (IJF)
AGHAKISHIYEV M. (AZE)	201	BICHOEV A. (IJF)	202	BICHOEV A. (IJF)	203	BICHOEV A. (IJF)	204	BICHOEV A. (IJF)
AGHAKISHIYEV M. (AZE)	203	BICHOEV A. (IJF)	204	BICHOEV A. (IJF)	205	BICHOEV A. (IJF)	206	BICHOEV A. (IJF)
AGHAKISHIYEV M. (AZE)	205	BICHOEV A. (IJF)	206	BICHOEV A. (IJF)	207	BICHOEV A. (IJF)	208	BICHOEV A. (IJF)
AGHAKISHIYEV M. (AZE)	207	BICHOEV A. (IJF)	208	BICHOEV A. (IJF)	209	BICHOEV A. (IJF)	210	BICHOEV A. (IJF)
AGHAKISHIYEV M. (AZE)	209	BICHOEV A. (IJF)	210	BICHOEV A. (IJF)	211	BICHOEV A. (IJF)	212	BICHOEV A. (IJF)
AGHAKISHIYEV M. (AZE)	211	BICHOEV A. (IJF)	212	BICHOEV A. (IJF)	213	BICHOEV A. (IJF)	214	BICHOEV A. (IJF)
AGHAKISHIYEV M. (AZE)	213	BICHOEV A. (IJF)	214	BICHOEV A. (IJF)	215	BICHOEV A. (IJF)	216	BICHOEV A. (IJF)
AGHAKISHIYEV M. (AZE)	215	BICHOEV A. (IJF)	216	BICHOEV A. (IJF)	217	BICHOEV A. (IJF)	218	BICHOEV A. (IJF)
AGHAKISHIYEV M. (AZE)	217	BICHOEV A. (IJF)	218	BICHOEV A. (IJF)	219	BICHOEV A. (IJF)	220	BICHOEV A. (IJF)
AGHAKISHIYEV M. (AZE)	219	BICHOEV A. (IJF)	220	BICHOEV A. (IJF)	221	BICHOEV A. (IJF)	222	BICHOEV A. (IJF)
AGHAKISHIYEV M. (AZE)	221	BICHOEV A. (IJF)	222	BICHOEV A. (IJF)	223	BICHOEV A. (IJF)	224	BICHOEV A. (IJF)
AGHAKISHIYEV M. (AZE)	223	BICHOEV A. (IJF)	224	BICHOEV A. (IJF)	225	BICHOEV A. (IJF)	226	BICHOEV A. (IJF)
AGHAKISHIYEV M. (AZE)	225	BICHOEV A. (IJF)	226	BICHOEV A. (IJF)	227	BICHOEV A. (IJF)	228	BICHOEV A. (IJF)
AGHAKISHIYEV M. (AZE)	227	BICHOEV A. (IJF)	228	BICHOEV A. (IJF)	229	BICHOEV A. (IJF)	230	BICHOEV A. (IJF)
AGHAKISHIYEV M. (AZE)	229	BICHOEV A. (IJF)	230	BICHOEV A. (IJF)	231	BICHOEV A. (IJF)	232	BICHOEV A. (IJF)



Quba Millennium Team Cadet European Cup 2025

Azerbaijan, Quba, 3-4 May 2025

-81 kg

Men (22)

POOL A

	KHIDIROV Ramazan	IJF	1	KHIDIROV R. (IJF)
	HAGVERDIYEV Jahandar	AZE	2	HAGVERDIYEV J. (AZE)
	SAHEDOV Aydyn	TKM	3	KURBANOV D. (KAZ)
	KURBANOV Dastan	KAZ	3	HUSEYNZADE S. (AZE)
	HUSEYNZADE Said	AZE	4	HUSEYNZADE S. (AZE)

POOL B

	SAMSIANI Saba	GEO	5	SAMSIANI S. (GEO)
	ABBASALI Mahammad	AZE	6	TCHENDJE KENMEUE A. (FRA)
	TCHENDJE KENMEUE Arthur	FRA	6	TCHENDJE KENMEUE A. (FRA)
	ALIEV Timur	IJF	7	ALIEV T. (IJF)
	SAFAROV Huseyn	AZE	8	MAMMADOV K. (AZE)
	MAMMADOV Kanan	AZE	8	MAMMADOV K. (AZE)

POOL C

	MEHDIYEV Amin	AZE	9	MEHDIYEV A. (AZE)
	ABBASOV Isgandar	AZE	10	NOVOSELOV A. (IJF)
	NOVOSELOV Artur	IJF	10	NOVOSELOV A. (IJF)
	AKHUNDOV Omar	AZE	11	AKHUNDOV O. (AZE)
	STREICHER Kellian	FRA	12	BAIZAK K. (KAZ)
	BAIZAK Kazhymukan	KAZ	12	BAIZAK K. (KAZ)

POOL D

	RAHMATOV Abdullah	AZE	13	RAHMATOV A. (AZE)
	PALTAYEV Ylham	TKM	14	PALTAYEV Y. (TKM)
	TORADZE Sandro	GEO	14	PALTAYEV Y. (TKM)
	ABDULLAYEV Tunar	AZE	15	ABDULLAYEV T. (AZE)
	BAKHTYBAIULY Beibarys	KAZ	16	BAKHTYBAIULY B. (KAZ)

REPECHAGE

HAGVERDIYEV J. (AZE)	29	HAGVERDIYEV J. (AZE)	33	HUSEYNZADE S. (AZE)
MAMMADOV K. (AZE)	30	MAMMADOV K. (AZE)	34	TCHENDJE KENMEUE A. (FRA)
NOVOSELOV A. (IJF)	31	NOVOSELOV A. (IJF)	35	NOVOSELOV A. (IJF)
BAKHTYBAIULY B. (KAZ)	32	BAKHTYBAIULY B. (KAZ)	36	RAHMATOV A. (AZE)

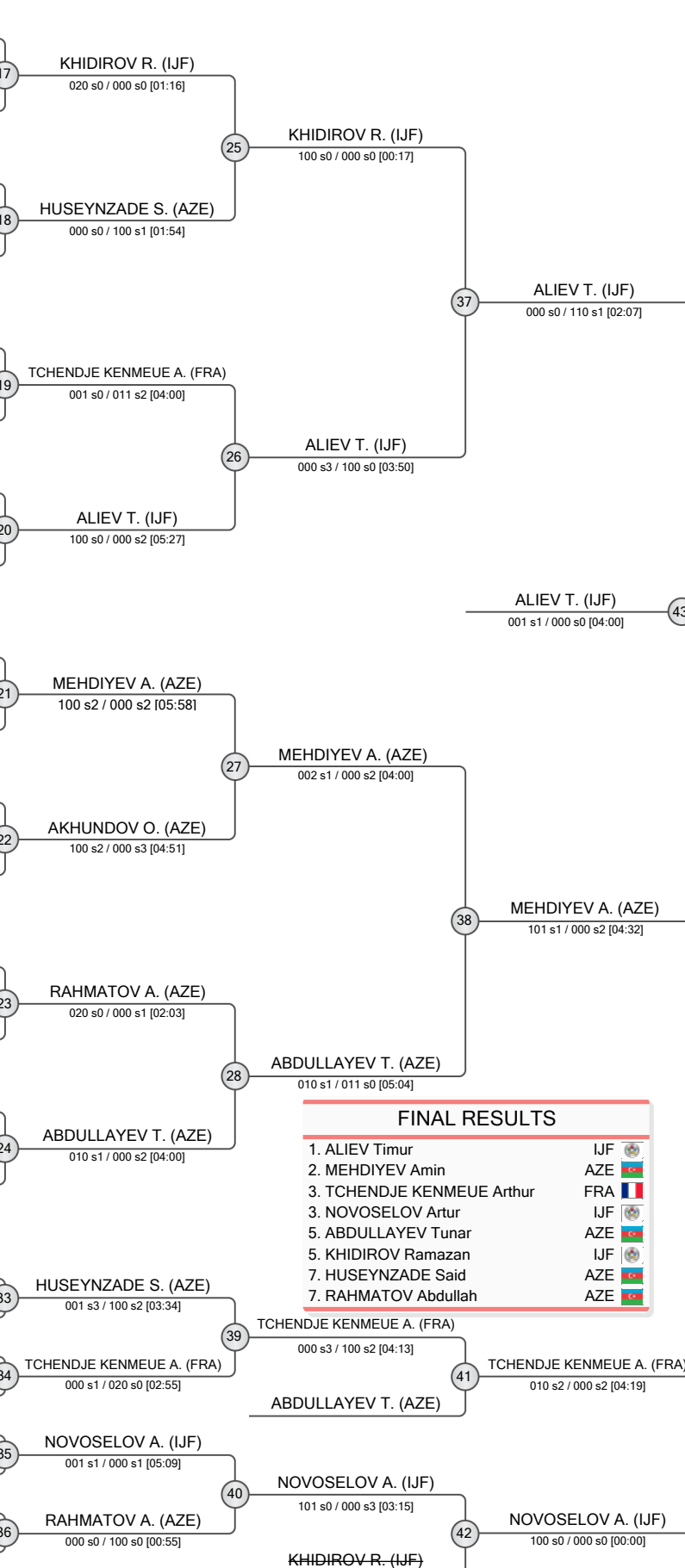

FINAL RESULTS

1.	ALIEV Timur	IJF	
2.	MEHDIYEV Amin	AZE	
3.	TCHENDJE KENMEUE Arthur	FRA	
3.	NOVOSELOV Artur	IJF	
5.	ABDULLAYEV Tunar	AZE	
7.	KHIDIROV Ramazan	IJF	
7.	HUSEYNZADE Said	AZE	
7.	RAHMATOV Abdullah	AZE	





Quba Millennium Team Cadet European Cup 2025

Azerbaijan, Quba, 3-4 May 2025

-90 kg

Men (21)

POOL A

	SULEIMANOV Abdula	IJF	1
	SHIRINOV Emin	AZE	2
	MULTON KANDU MPALA Cedric	FRA	3
	AMANGALI Alinur	KAZ	4
	ALIYEV Tamerlan	AZE	4

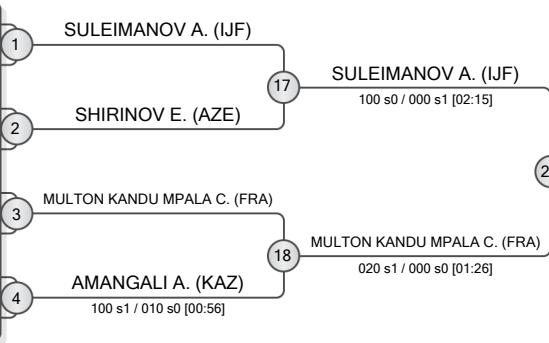

POOL B

	GADRANI Nikoloz	GEO	5
	RAHIMBERDIYEV Myratdurdy	TKM	6
	KHAZRIYEV Amir	AZE	6
	KIRYLAU Arseni	IF1	7
	ILIYASOV Khalid	AZE	8

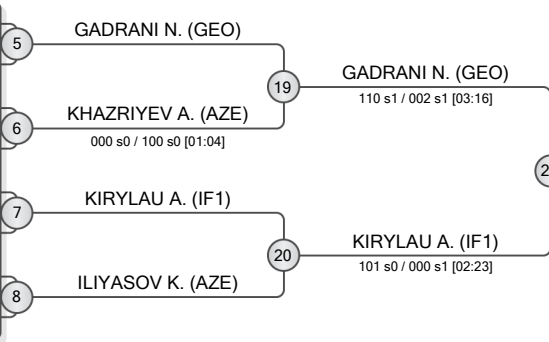

POOL C

	ABGAIDZE Luka	GEO	9
	MAMIEV Atmir	IJF	10
	HUSEYNOV Huseyn	AZE	10
	RIZABEK Aldiyar	KAZ	11
	SIUKASHVILI Sandro	GEO	12
	IMANOV Raul	AZE	12

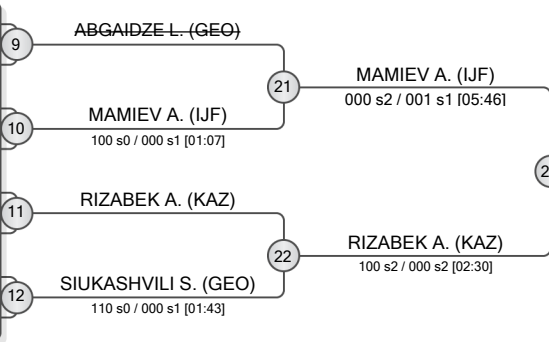

POOL D

	HUSEYNOV Said	AZE	13
	UTSIEV Apti	IJF	14
	RIKHARD Damir	KAZ	14
	SALIEV Alikhan	KGZ	15
	ALIYEV Nuraddin	AZE	16

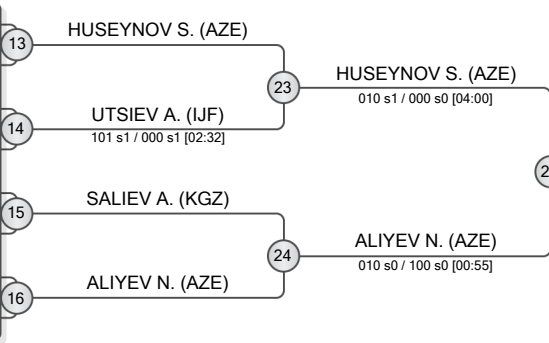

REPECHAGE

SHIRINOV E. (AZE)	29	SHIRINOV E. (AZE)	33
ILIYASOV K. (AZE)	30	GADRANI N. (GEO)	34
HUSEYNOV H. (AZE)		ABGAIDZE L. (GEO)	35
ABGAIDZE L. (GEO)	31	RIZABEK A. (KAZ)	
UTSIEV A. (IJF)	32	UTSIEV A. (IJF)	40
		ALIYEV N. (AZE)	36

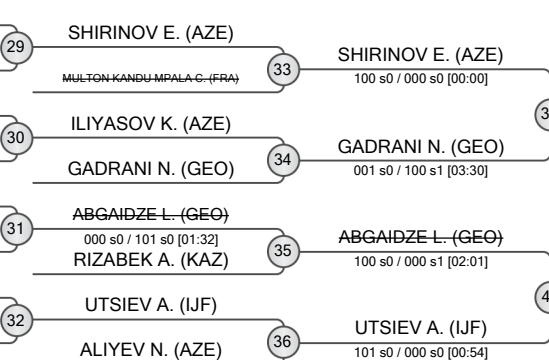

FINAL RESULTS	
1. SULEIMANOV Abdula	IJF
2. HUSEYNOV Said	AZE
3. MAMIEV Atmir	IJF
3. UTSIEV Apti	IJF
5. SHIRINOV Emin	AZE
7. KIRYLAU Arseni	IF1
7. GADRANI Nikoloz	GEO





Quba Millennium Team Cadet European Cup 2025

Azerbaijan, Quba, 3-4 May 2025

+ 90 kg

Men (21)

POOL A

	AKHUNDOV Subhan	AZE	1	AKHUNDOV S. (AZE)
	YESSENGELDI Yerkanat	KAZ	2	YESSENGELDI Y. (KAZ)
	RUSTAMOV Arslan	TKM		100 s2 / 000 s3 [03:05]
	BAZARKATOV Yeraly	KAZ	3	BAZARKATOV Y. (KAZ)
	JAPARIDZE Otari	GEO	4	JAPARIDZE O. (GEO)
	AFANDIYEV Tahir	AZE		100 s0 / 000 s0 [00:12]

POOL B

	KULIGIN Denis	IJF	5	KULIGIN D. (IJF)
	FARZALIYEV Elshan	AZE	6	LUKASHEVICH D. (IF1)
	LUKASHEVICH Daniil	IF1		000 s0 / 100 s0 [00:19]
	KASHIBADZE Giorgi	GEO	7	KASHIBADZE G. (GEO)
	RUSLANULY Arslan	KAZ	8	RUSLANULY A. (KAZ)

POOL C

	ZAKUTASHVILI Ilia	GEO	9	ZAKUTASHVILI I. (GEO)
	SATINBEK Yerassyl	KAZ	10	SATINBEK Y. (KAZ)
	MASIMOV Javidan	AZE	11	MASIMOV J. (AZE)
	ZUBKOV Viacheslav	IJF	12	ZUBKOV V. (IJF)
	SHAIKH MUBARK Mohammed	KSA		102 s0 / 000 s0 [00:57]

POOL D

	DEKENNE DIFFO Azriel	FRA	13	DEKENNE DIFFO A. (FRA)
	HAJILI Omar	AZE	14	MAKSOTULY A. (KAZ)
	MAKSOTULY Ali	KAZ		000 s0 / 110 s0 [01:17]
	FARZALIYEV Tunar	AZE	15	FARZALIYEV T. (AZE)
	KHARLOV Pavel	IJF	16	KHARLOV P. (IJF)

REPECHAGE

29	YESSENGELDI Y. (KAZ)	33	JAPARIDZE O. (GEO)
30	LUKASHEVICH D. (IF1)	34	LUKASHEVICH D. (IF1)
31	SATINBEK Y. (KAZ)	35	MASIMOV J. (AZE)
32	KHARLOV P. (IJF)	36	KHARLOV P. (IJF)

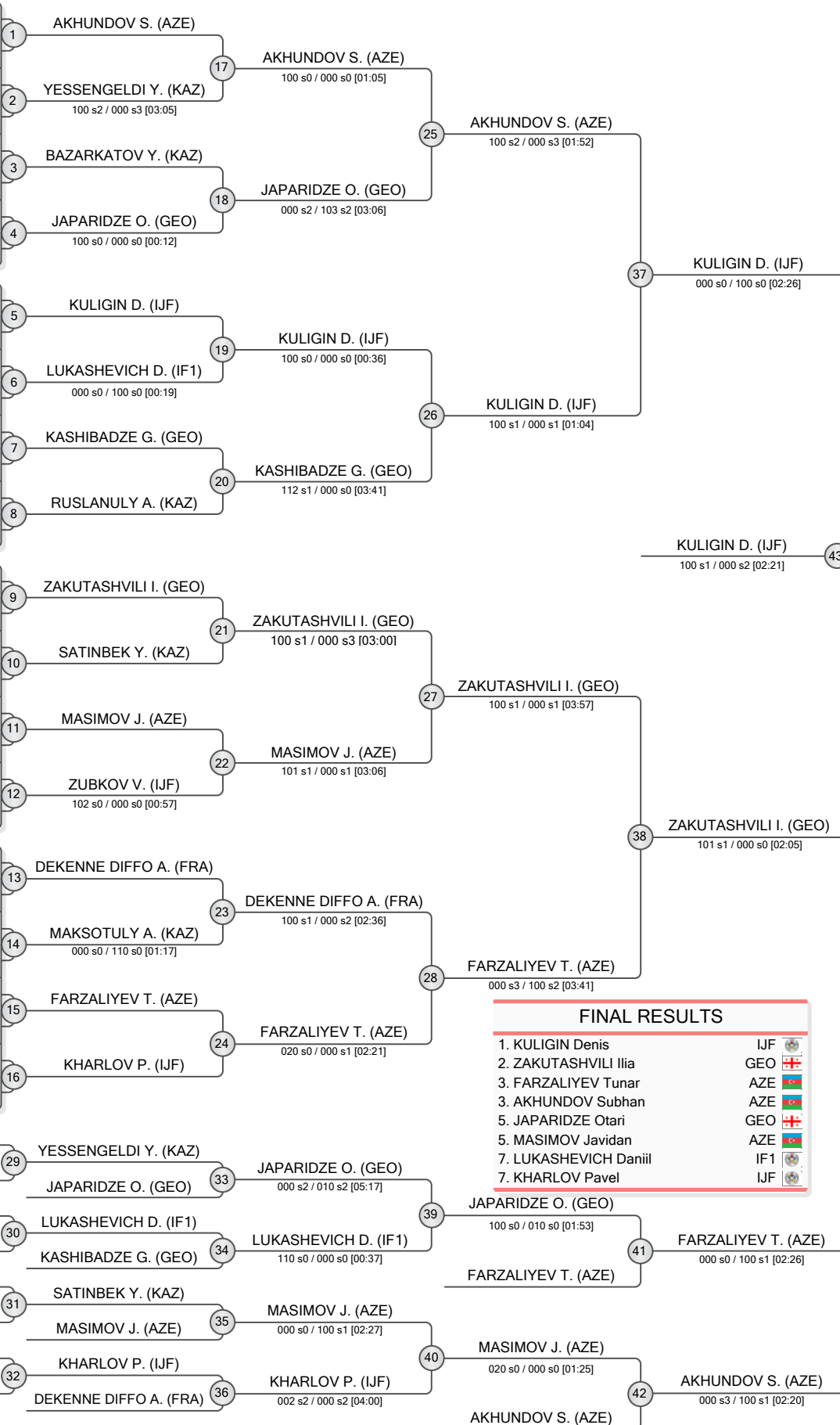

FINAL RESULTS

1.	KULIGIN Denis	IJF	
2.	ZAKUTASHVILI Ilia	GEO	
3.	FARZALIYEV Tunar	AZE	
3.	AKHUNDOV Subhan	AZE	
5.	JAPARIDZE Otari	GEO	
5.	MASIMOV Javidan	AZE	
7.	LUKASHEVICH Daniil	IF1	
7.	KHARLOV Pavel	IJF	





Quba Millennium Team Cadet European Cup 2025

Azerbaijan, Quba, 3-4 May 2025

-40 kg

Women (9)

POOL A

	COSKUN Busra Ceylin	TUR
	RZAZADE Zahra	AZE

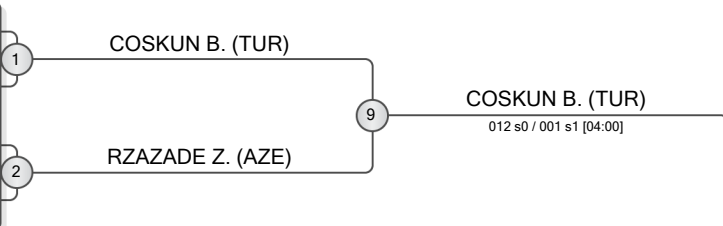

POOL B

	SAIFUTDINOVA Emiliia	IJF
	SHEVCHUK Anastasiia	IJF

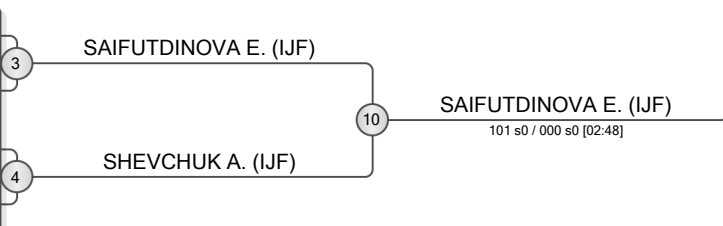

POOL C

	YILMAZTURK Yagmur	TUR
	SALMANOVA Sunay	AZE
	MIRZAZADA Leyla	AZE

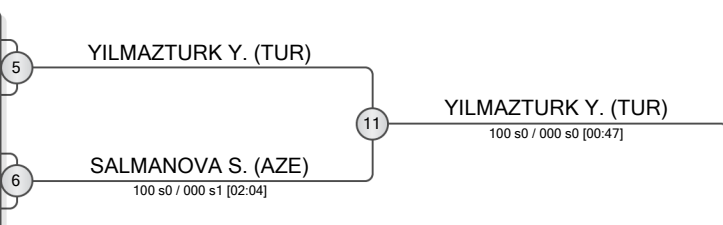

POOL D

	YUKSEL Sema Nur	TUR
	DZEBOEVA Amina	IJF

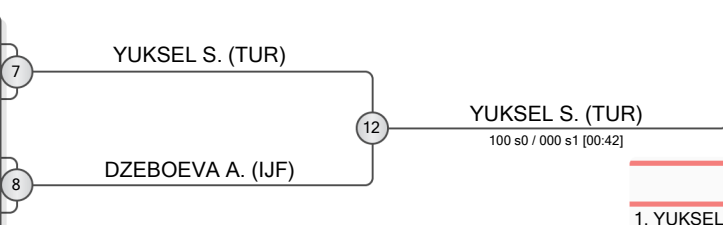

REPECHAGE

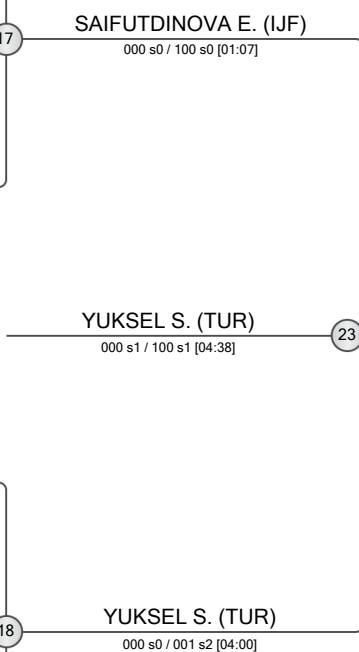
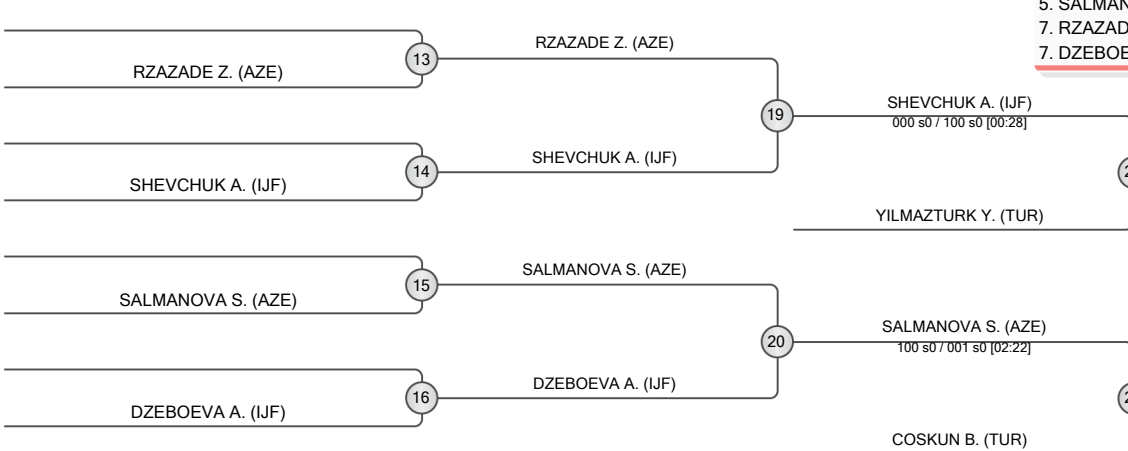

FINAL RESULTS		
1.	YUKSEL Sema Nur	TUR
2.	SAIFUTDINOVA Emiliia	IJF
3.	YILMAZTURK Yagmur	TUR
3.	COSKUN Busra Ceylin	TUR
5.	SHEVCHUK Anastasiia	IJF
5.	SALMANOVA Sunay	AZE
7.	RZAZADE Zahra	AZE
7.	DZEBOEVA Amina	IJF





Quba Millennium Team Cadet European Cup 2025

Azerbaijan, Quba, 3-4 May 2025

-44 kg

Women (19)

POOL A

	MEKI Fatma Zehra	TUR
	URBAN Noemie	FRA
	GELDIYEVA Ejegyz	TKM
	BYKOVA Anastasiia	IJF
	ABDULLAYEVA Fatima	AZE

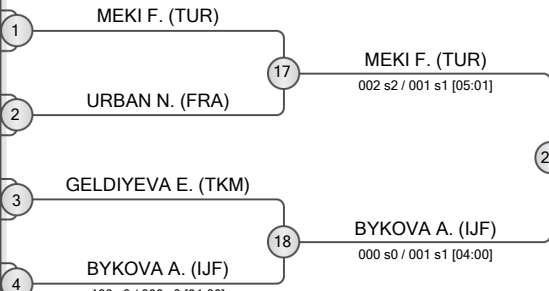

POOL B

	GADANOVA Alina	IJF
	ABDUKADYROVA Sevinch	KAZ
	ABDULLAYEVA Khadija	AZE
	ULIUMDZHEVA Valeriia	IJF
	MANASBEKOVA Munira	KGZ

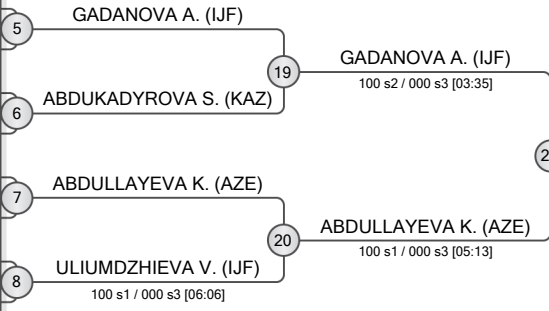

POOL C

	MISHENKINA Nadezhda	IJF
	HUSEYNOVA Govhar	AZE
	ORISHCHENKO Anna-Mariia	IJF
	BARATOVA Nasiba	TKM
	SEYIDZADE Zeynab	AZE

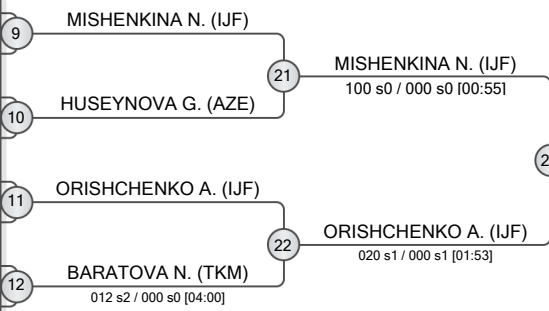

POOL D

	KAYIR Livanur	TUR
	TALGAT Nazym	KAZ
	HUSEYNOVA Gulshan	AZE
	AKHTIAMOVA Regina	IJF

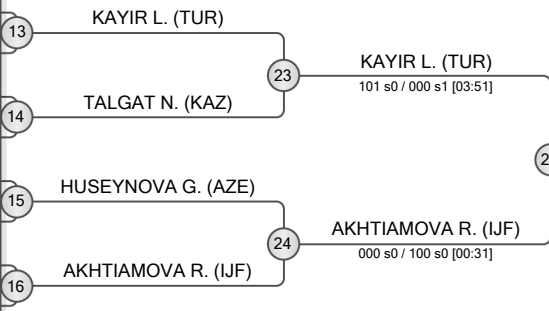

REPECHAGE

ABDULLAYEVA F. (AZE)	29	ABDULLAYEVA F. (AZE)	33
GELDIYEVA E. (TKM)		MEKI F. (TUR)	
ULIUMDZHEVA V. (IJF)	30	ULIUMDZHEVA V. (IJF)	34
HUSEYNOVA G. (AZE)	31	ORISHCHENKO A. (IJF)	35
TALGAT N. (KAZ)	32	AKHTIAMOVA R. (IJF)	36

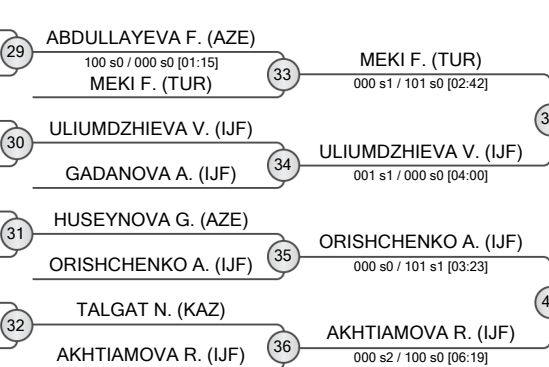

FINAL RESULTS		
1.	MISHENKINA Nadezhda	IJF
2.	BYKOVA Anastasiia	IJF
3.	KAYIR Livanur	TUR
3.	ABDULLAYEVA Khadija	AZE
5.	MEKI Fatma Zehra	TUR
7.	ULIUMDZHEVA Valeriia	IJF
7.	AKHTIAMOVA Regina	IJF





Quba Millennium Team Cadet European Cup 2025

Azerbaijan, Quba, 3-4 May 2025

-48 kg

Women (19)

POOL A

	ALAKBAROVA Leyla	AZE	1	ALAKBAROVA L. (AZE)
	MOLDAGALI Sandugash	KAZ	2	AIMUKHAMEDOVA S. (IJF)
	AIMUKHAMEDOVA Sabina	IJF		000 s0 / 100 s0 [01:38]
	MUSAYEVA Gulgaz	AZE	3	MUSAYEVA G. (AZE)
	PULJIC Lucija	CRO	4	PULJIC L. (CRO)

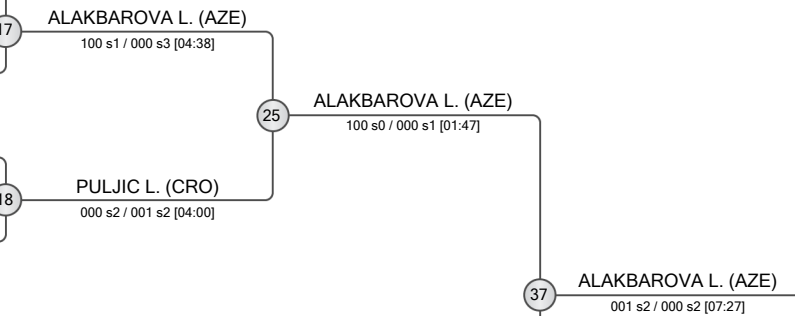

POOL B

	MILHAVET Agathe	FRA	5	MILHAVET A. (FRA)
	MESHCHERIAKOVA Varvara	IJF	6	MESHCHERIAKOVA V. (IJF)
	AHMADOVA Nargiz	AZE	7	AHMADOVA N. (AZE)
	BOSKUP Aysenur	TUR	8	BOSKUP A. (TUR)

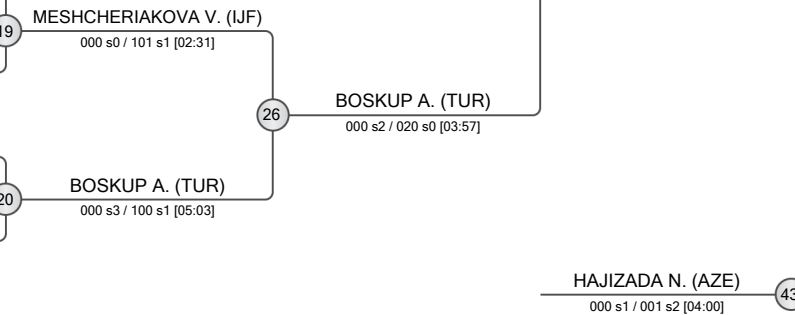

POOL C

	HAJIZADA Nurana	AZE	9	HAJIZADA N. (AZE)
	TSURTSUMIA Mariam	GEO	10	RINATKYZY A. (KAZ)
	RINATKYZY Ayazhan	KAZ		000 s0 / 100 s0 [00:43]
	BOGUS Alina	IJF	11	BOGUS A. (IJF)
	MAMISHOVA Nigar	AZE	12	MAMISHOVA N. (AZE)

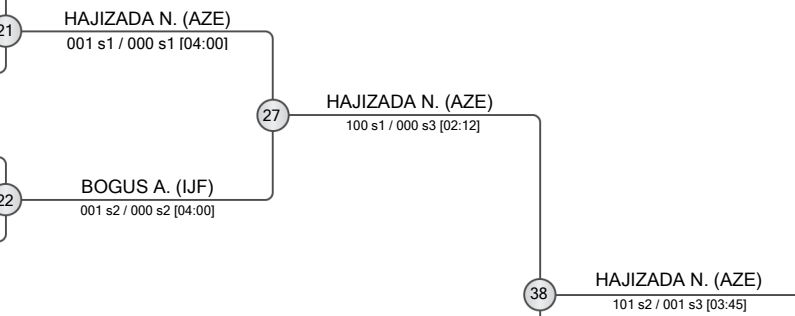

POOL D

	EYVAZLI Konul	AZE	13	EYVAZLI K. (AZE)
	PARDAYEVA Nuriya	TKM	14	PARDAYEVA N. (TKM)
	DARE Zayi	FRA	15	DARE Z. (FRA)
	GASIMOVA Gulnara	AZE	16	KHURANOVA K. (IJF)
	KHURANOVA Karina	IJF		000 s3 / 100 s1 [04:29]

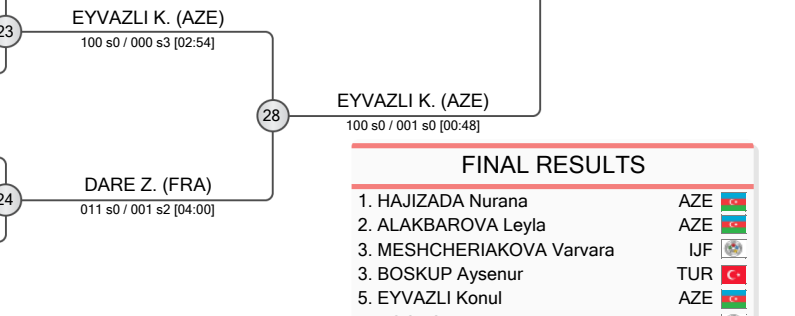

FINAL RESULTS

- HAJIZADA Nurana AZE
- ALAKBAROVA Leyla AZE
- MESHCHERIAKOVA Varvara IJF
- BOSKUP Aysenur TUR
- EYVAZLI Konul AZE
- BOGUS Alina IJF
- AIMUKHAMEDOVA Sabina IJF
- PARDAYEVA Nuriya TKM

REPECHAGE

29	AIMUKHAMEDOVA S. (IJF)	33	PULJIC L. (CRO)
30	AHMADOVA N. (AZE)	34	MESHCHERIAKOVA V. (IJF)
31	RINATKYZY A. (KAZ)	35	BOGUS A. (IJF)
32	PARDAYEVA N. (TKM)	36	PARDAYEVA N. (TKM)

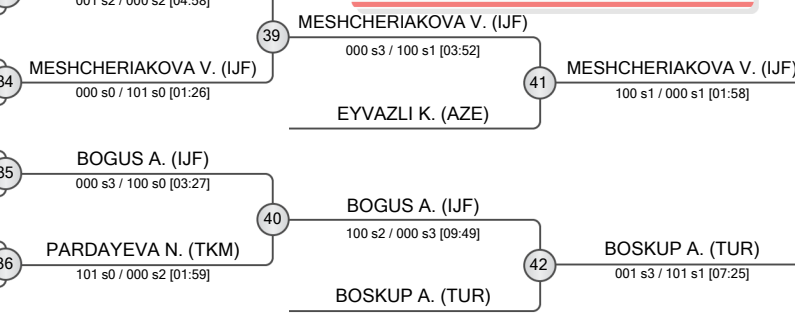



Quba Millennium Team Cadet European Cup 2025

Azerbaijan, Quba, 3-4 May 2025

-52 kg

Women (20)

POOL A

	KOZLOVA Valeriia	IJF	1	KOZLOVA V. (IJF)
	SARSENOVA Aruzhan	KAZ	2	SARSENOVA A. (KAZ)
	AHMADZADA Yaghmur	AZE		022 s1 / 000 s1 [03:01]
	MURSALIYEVA Maleyka	AZE	3	MURSALIYEVA M. (AZE)
	TUCAJ Martina	CRO	4	TUCAJ M. (CRO)

POOL B

	FURMAN Polina	IJF	5	FURMAN P. (IJF)
	AIDARKYZY Damira	KAZ	6	AIDARKYZY D. (KAZ)
	KHARAISHVILI Nino	GEO	7	KHARAISHVILI N. (GEO)
	AKBAROVA Qizilgul	AZE	8	ZHARSKAYA A. (IF1)
	ZHARSKAYA Alisiya	IF1		000 s2 / 013 s0 [04:00]

POOL C

	MAMMADOVA Aysun	AZE	9	MAMMADOVA A. (AZE)
	IVANOVA Alina	IJF	10	IVANOVA A. (IJF)
	ZIVKOVIC Valentina	CRO	11	ZIVKOVIC V. (CRO)
	GULIYEVA Sona	AZE	12	MAISEYENKA A. (IF1)
	MAISEYENKA Aliaksandra	IF1		000 s2 / 100 s1 [01:41]

POOL D

	BAILLEUL Helea	FRA	13	BAILLEUL H. (FRA)
	ERKINOVA Bahar	TKM	14	SHIKHMAMMADOVA N. (AZE)
	SHIKHMAMMADOVA Nargiz	AZE		000 s1 / 100 s0 [04:57]
	LOPEZ Alice	FRA	15	LOPEZ A. (FRA)
	DURALI Ayazhan	KAZ	16	DURALI A. (KAZ)

REPECHAGE

	SARSENOVA A. (KAZ)	29	SARSENOVA A. (KAZ)		TUCAJ M. (CRO)	33	TUCAJ M. (CRO)
	AIDARKYZY D. (KAZ)	30	AIDARKYZY D. (KAZ)		ZHARSKAYA A. (IF1)	34	ZHARSKAYA A. (IF1)
	IVANOVA A. (IJF)	31	IVANOVA A. (IJF)		ZIVKOVIC V. (CRO)	35	ZIVKOVIC V. (CRO)
	DURALI A. (KAZ)	32	DURALI A. (KAZ)		BAILLEUL H. (FRA)	36	BAILLEUL H. (FRA)

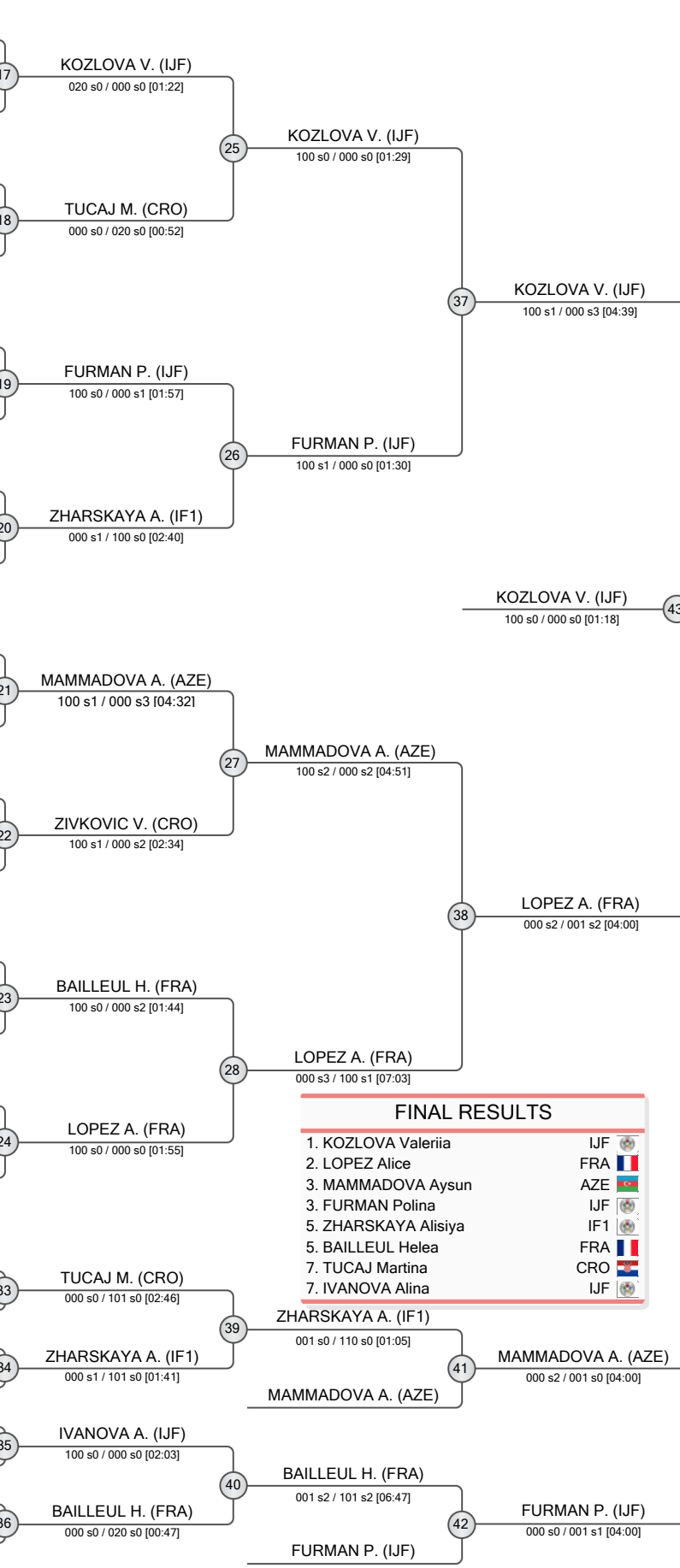

FINAL RESULTS

1.	KOZLOVA Valeriia	IJF	
2.	LOPEZ Alice	FRA	
3.	MAMMADOVA Aysun	AZE	
3.	FURMAN Polina	IJF	
5.	ZHARSKAYA Alisiya	IF1	
5.	BAILLEUL Helea	FRA	
7.	TUCAJ Martina	CRO	
7.	IVANOVA Alina	IJF	





Quba Millennium Team Cadet European Cup 2025

Azerbaijan, Quba, 3-4 May 2025

-57 kg

Women (23)

POOL A

	KILIC Elif	TUR
	RABTSAVA Valeryia	IF1
	KARABIKHINA Ekaterina	IJF
	BELOVA Anastasiia	IJF
	ALLAHVERDIYEVA Khadija	AZE
	DASTANKYZY Balnur	KAZ

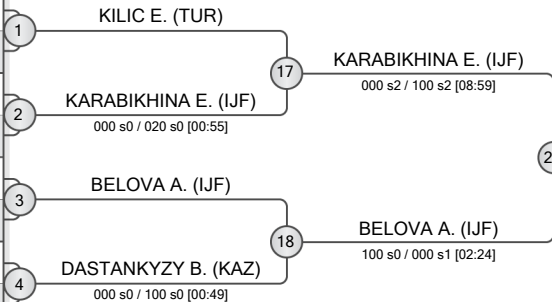

POOL B

	GAMIASHVILI Tamar	GEO
	JUMAYEVA Zohre	TKM
	MAMMADTAGHIYEVA Gulnaz	AZE
	KIRILLOVA Stefaniia	IJF
	VALIYEVA Nazakat	AZE

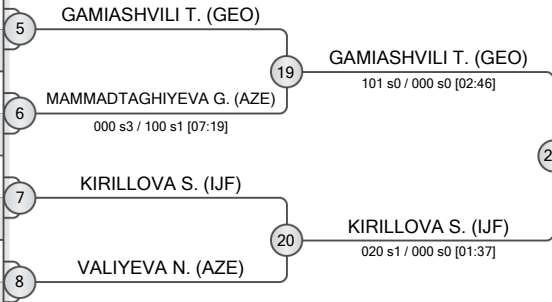

POOL C

	KAKITAEVA Aidai	KGZ
	RUSTAMOVA Aliya	AZE
	KALOEVA Zita	IJF
	MINKO Sofiya	IF1
	ZHDANOVA Ekaterina	IJF
	YADIGARLI Lale	AZE

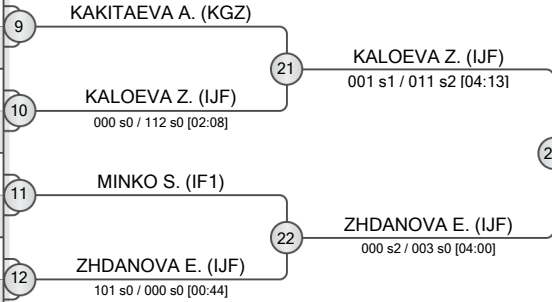

POOL D

	DYE Isciane	FRA
	SEYITKULOVA Shadyana	TKM
	GADIROVA Ayan	AZE
	DOS REIS Constance	FRA
	TSVETOVA Tatiana	IJF
	VALIZADA Sama	AZE

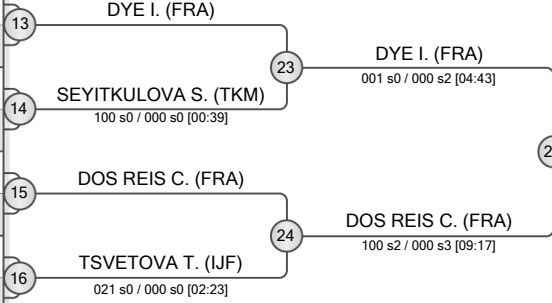

REPECHAGE

29 DASTANKYZY B. (KAZ)	30 MAMMADTAGHIYEVA G. (AZE)	31 MINKO S. (IF1)	32 SEYITKULOVA S. (TKM)
33 KARABIKHINA E. (IJF)	34 KIRILLOVA S. (IJF)	35 KALOEVA Z. (IJF)	36 DOS REIS C. (FRA)

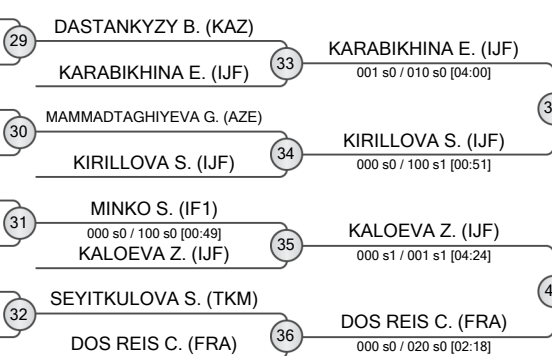

FINAL RESULTS	
1. ZHDANOVA Ekaterina	IJF
2. BELOVA Anastasiia	IJF
3. KIRILLOVA Stefaniia	IJF
4. GAMIASHVILI Tamar	GEO
5. DYE Isciane	FRA
6. KALOEVA Zita	IJF
7. KARABIKHINA Ekaterina	IJF
7. DOS REIS Constance	FRA





Quba Millennium Team Cadet European Cup 2025

Azerbaijan, Quba, 3-4 May 2025

-63 kg

Women (16)

POOL A

	DALMASSO Madeleine	FRA
	KUAT Yerkenur	KAZ
	MARGIEVA Marianna	IJF
	HUSEYNLI Zilan	AZE

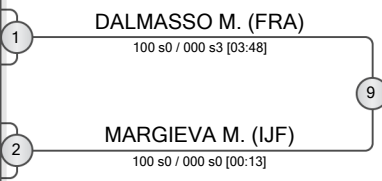

POOL B

	JEAN Chloe	FRA
	MARKHVAIDZE Lizi	GEO
	LISOUSKAYA Sofya	IF1
	HUSEYNZADA Zahra	AZE

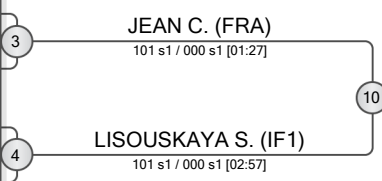

POOL C

	ALIEVA Aishat	IJF
	BEGMYRADOVA Intizar	TKM
	SERIK Azima	KAZ
	BAGHIRLI Aydan	AZE

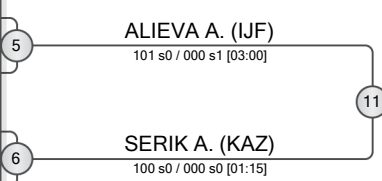

POOL D

	KILICKAYA Rumeysa Hatice	TUR
	POPOVIC Kaja	CRO
	AYDIN Isil Sinem	TUR
	KRASKO Varvara	IF1

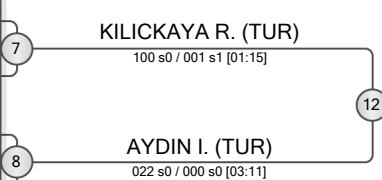

REPECHAGE

13	MARGIEVA M. (IJF)	001 s0 / 100 s0 [00:58]
14	LISOUSKAYA S. (IF1)	000 s1 / 111 s0 [03:46]
15	SERIK A. (KAZ)	000 s1 / 111 s0 [03:46]
16	AYDIN I. (TUR)	000 s1 / 111 s0 [03:46]

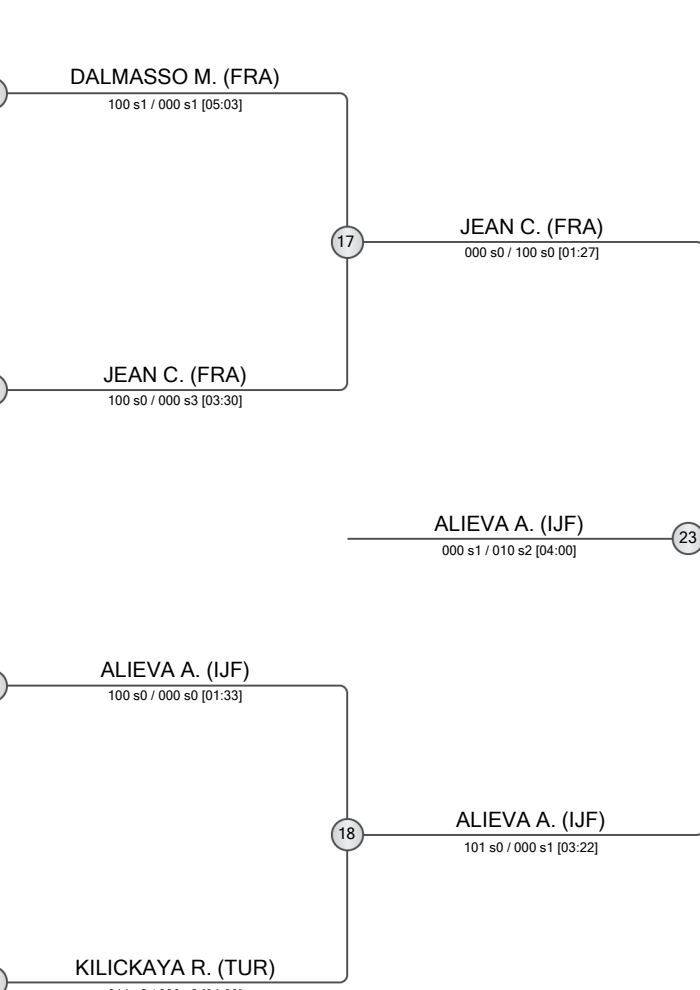
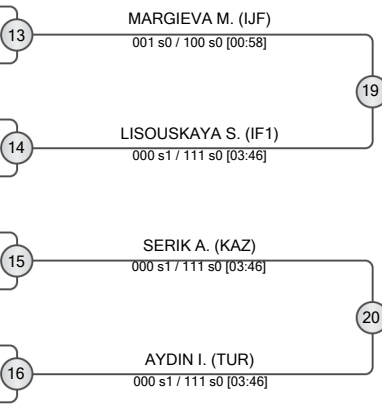

FINAL RESULTS		
1.	ALIEVA Aishat	IJF
2.	JEAN Chloe	FRA
3.	MARGIEVA Marianna	IJF
3.	DALMASSO Madeleine	FRA
5.	KILICKAYA Rumeysa Hatice	TUR
5.	AYDIN Isil Sinem	TUR
7.	LISOUSKAYA Sofya	IF1
7.	SERIK Azima	KAZ





Quba Millennium Team Cadet European Cup 2025

Azerbaijan, Quba, 3-4 May 2025

-70 kg

Women (18)

POOL A

	RULLIER Lucie	FRA	1	RULLIER L. (FRA)
	BAYRAMLI Malak	AZE	2	BAYRAMLI M. (AZE)
	MAMMADLI Masuma	AZE	3	MAMMADLI M. (AZE)
	TUKAN Adelina	IJF	4	TUKAN A. (IJF)

POOL B

	KHOJANAZAROVA Uldana	KAZ	5	KHOJANAZAROVA U. (KAZ)
	GHVALADZE Maia	GEO	6	GHVALADZE M. (GEO)
	CHEKMAREVA Alina	IJF	7	CHEKMAREVA A. (IJF)
	HASANOVA Jennet	TKM	8	HASANOVA J. (TKM)
	MIRZAGHAYEVA Aynur	AZE	8	100 s0 / 000 s0 [00:33]

POOL C

	DZAGANIA Nini	GEO	9	DZAGANIA N. (GEO)
	OZBUDAK Done Melike	TUR	10	OZBUDAK D. (TUR)
	DZHIGAROS Darina	IJF	11	DZHIGAROS D. (IJF)
	NASIROVA Famila	AZE	12	NASIROVA F. (AZE)

POOL D

	KONOKBAEVA Azima	KGZ	13	KONOKBAEVA A. (KGZ)
	YARMANTOVICH Sofya	IF1	14	YARMANTOVICH S. (IF1)
	JALILLI Fidan	AZE	14	020 s0 / 000 s1 [02:25]
	RUSLANOVA Oguljan	TKM	15	RUSLANOVA O. (TKM)
	AHMADOVA Rena	AZE	16	AHMADOVA R. (AZE)

REPECHAGE

	BAYRAMLI M. (AZE)	29	BAYRAMLI M. (AZE)	33	TUKAN A. (IJF)
	KHOJANAZAROVA U. (KAZ)	30	KHOJANAZAROVA U. (KAZ)	34	CHEKMAREVA A. (IJF)
	OZBUDAK D. (TUR)	31	OZBUDAK D. (TUR)	35	DZHIGAROS D. (IJF)
	AHMADOVA R. (AZE)	32	AHMADOVA R. (AZE)	36	YARMANTOVICH S. (IF1)

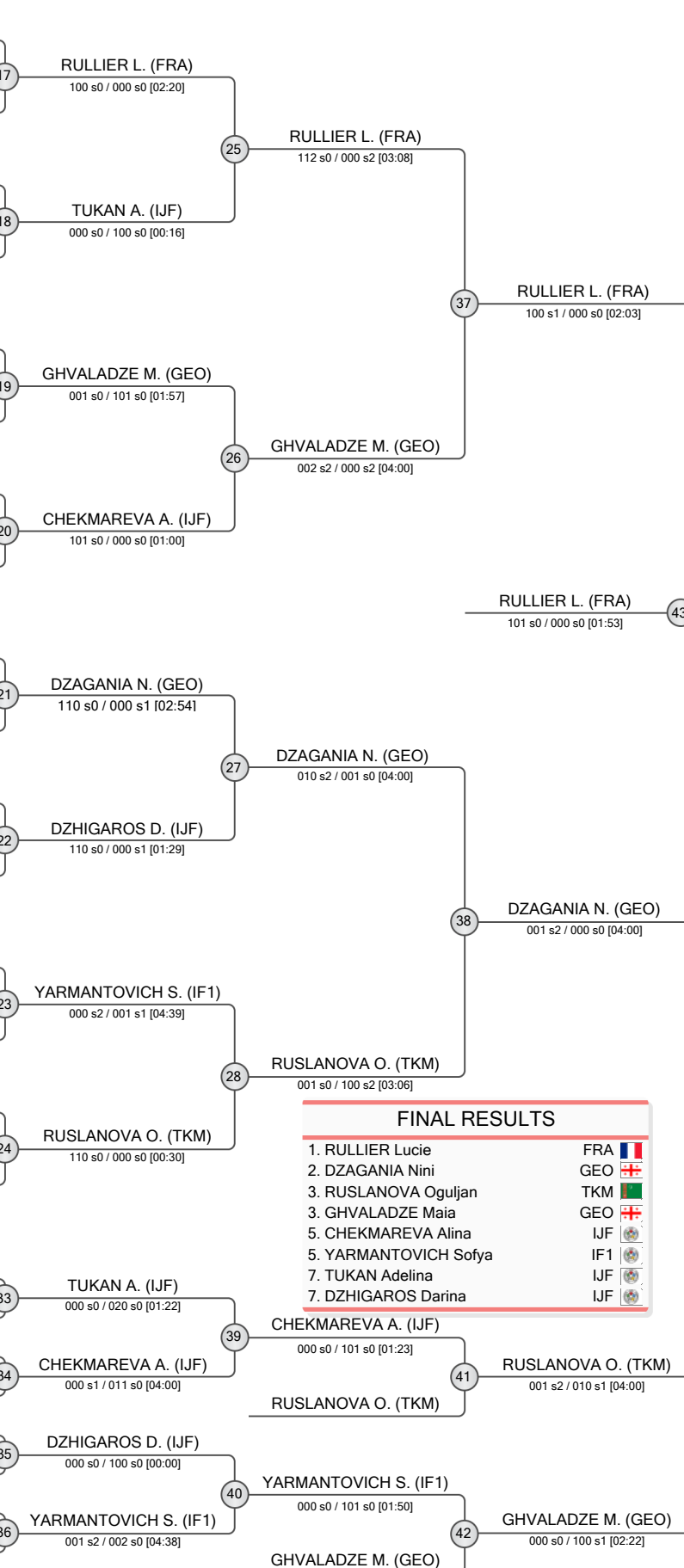

FINAL RESULTS

1.	RULLIER Lucie	FRA	
2.	DZAGANIA Nini	GEO	
3.	RUSLANOVA Oguljan	TKM	
3.	GHVALADZE Maia	GEO	
5.	CHEKMAREVA Alina	IJF	
7.	YARMANTOVICH Sofya	IF1	
7.	TUKAN Adelina	IJF	
7.	DZHIGAROS Darina	IJF	





Quba Millennium Team Cadet European Cup 2025

Azerbaijan, Quba, 3-4 May 2025

+70 kg

Women (17)

POOL A

	FEUILLET--NGUIMGO Emma	FRA	1	FEUILLET--NGUIMGO E. (FRA)	
	KENZHEKHANKYZY Kadisha	KAZ	2	KENZHEKHANKYZY K. (KAZ)	
	ALIYEVA Zemfira	AZE	3	ALIYEVA Z. (AZE)	
	ZHELEVA Anna	IJF	4	ZHELEVA A. (IJF)	
				17	FEUILLET--NGUIMGO E. (FRA) 100 s0 / 000 s0 [00:20]
				18	ZHELEVA A. (IJF) 000 s0 / 110 s0 [01:05]
				25	ZHELEVA A. (IJF) 001 s1 / 010 s1 [04:00]

POOL B

	BALCI Hatice Tuana	TUR	5	BALCI H. (TUR)	
	GULIYEVA Aysu	AZE	6	GULIYEVA A. (AZE)	
	SERIN Nisanur	TUR	7	SERIN N. (TUR)	
	BAGAEVA Vanessa	IJF	8	BAGAEVA V. (IJF)	
				19	BALCI H. (TUR) 100 s1 / 000 s3 [02:00]
				20	SERIN N. (TUR) 001 s0 / 000 s2 [04:00]
				26	BALCI H. (TUR) 100 s2 / 010 s3 [03:59]

POOL C

	AJDUKOVIC Antea	CRO	9	AJDUKOVIC A. (CRO)	
	SHADOVA Diliana	IJF	10	VALIZADA N. (AZE) 000 s0 / 002 s2 [04:00]	
	VALIZADA Nargiz	AZE	11	TOLEBAY T. (KAZ)	
	TOLEBAY Togzhan	KAZ	11	TOLEBAY T. (KAZ)	
	SASSA-TATUKILA Theresse - Grace	FRA	12	SASSA-TATUKILA T. (FRA)	
				21	AJDUKOVIC A. (CRO) 021 s0 / 001 s0 [01:49]
				22	SASSA-TATUKILA T. (FRA) 000 s2 / 010 s1 [04:00]
				27	SASSA-TATUKILA T. (FRA) 011 s0 / 021 s0 [02:39]

POOL D

	KVARATSKHELIA Nona	GEO	13	KVARATSKHELIA N. (GEO)	
	HABIBLI Daniz	AZE	14	HABIBLI D. (AZE)	
	KOZONOVA Vladislava	IJF	15	KOZONOVA V. (IJF)	
	JUMAKULYYEVA Joragul	TKM	16	JUMAKULYYEVA J. (TKM)	
				23	KVARATSKHELIA N. (GEO) 110 s0 / 000 s0 [00:41]
				24	KOZONOVA V. (IJF) 100 s0 / 000 s0 [00:19]
				28	KVARATSKHELIA N. (GEO) 100 s2 / 000 s0 [02:05]

REPECHAGE

				29	ALIYEVA Z. (AZE)
				30	GULIYEVA A. (AZE)
				31	TOLEBAY T. (KAZ)
				32	HABIBLI D. (AZE)
				33	FEUILLET--NGUIMGO E. (FRA) 000 s0 / 111 s0 [00:53]
				34	SERIN N. (TUR) 000 s3 / 100 s1 [02:36]
				35	AJDUKOVIC A. (CRO) 000 s3 / 100 s1 [03:50]
				36	HABIBLI D. (AZE) 100 s0 / 000 s0 [00:00]
				39	FEUILLET--NGUIMGO E. (FRA) 001 s1 / 000 s1 [04:00]
				40	AJDUKOVIC A. (CRO) 110 s0 / 000 s1 [01:15]
				41	FEUILLET--NGUIMGO E. (FRA) 100 s0 / 000 s0 [02:12]
				42	AJDUKOVIC A. (CRO) 100 s0 / 000 s0 [00:00]

				37	ZHELEVA A. (IJF) 100 s0 / 000 s1 [01:43]
				43	KVARATSKHELIA N. (GEO) 011 s0 / 100 s0 [01:04]
				38	KVARATSKHELIA N. (GEO) 000 s2 / 001 s2 [04:00]

FINAL RESULTS

1.	KVARATSKHELIA Nona	GEO	
2.	ZHELEVA Anna	IJF	
3.	FEUILLET--NGUIMGO Emma	FRA	
3.	AJDUKOVIC Antea	CRO	
5.	SASSA-TATUKILA Theresse - Grace	FRA	
5.	BALCI Hatice Tuana	TUR	
7.	SERIN Nisanur	TUR	
7.	HABIBLI Daniz	AZE	

