

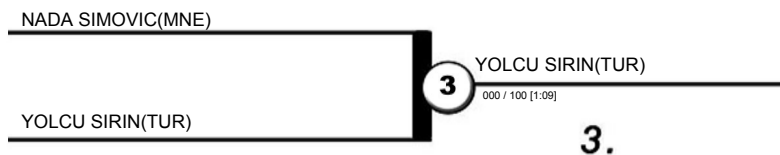

40 KG
4 Judoka

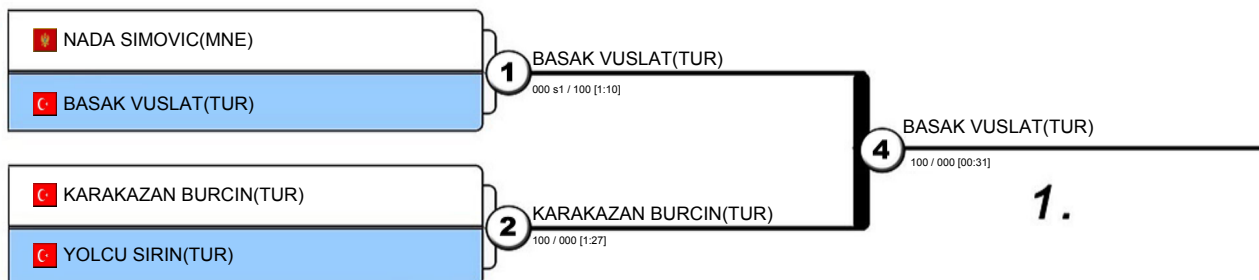

Results
Resultat / Platzierungen

1. BASAK VUSLAT(TUR)
2. KARAKAZAN BURCIN(TUR)
3. YOLCU SIRIN(TUR)
3. NADA SIMOVIC(MNE)



BALKAN JUDO ASSOCIATION
BALKAN JUDO CHAMPIONSHIP For CADETS (U18)
 May 09 - 10 , 2026 - BUDVA, MONTENEGRO

44 KG
 7 Judoka

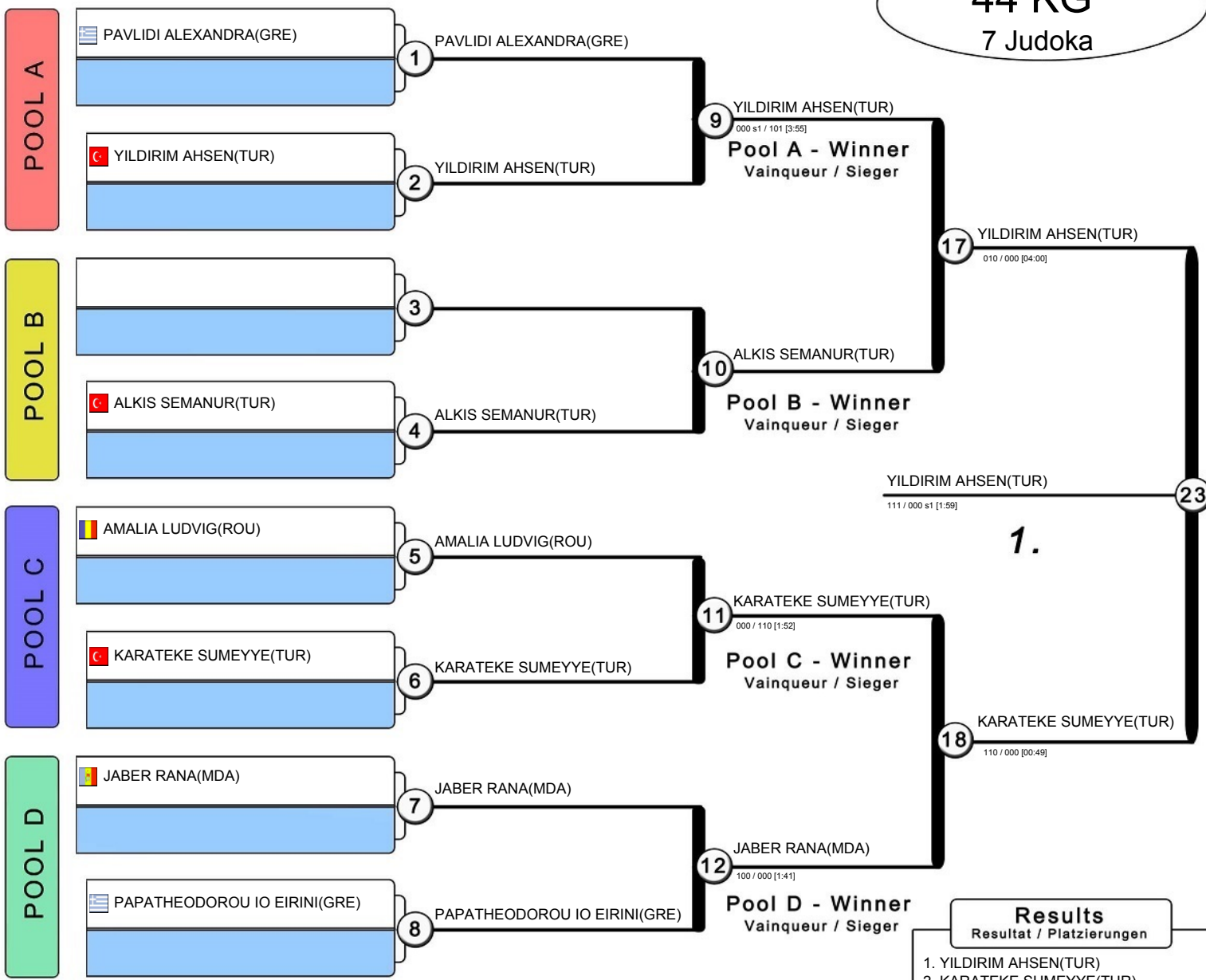

Results	
Resultat / Platzierungen	
1.	YILDIRIM AHSEN(TUR)
2.	KARATEKE SUMEYYE(TUR)
3.	PAVLIDI ALEXANDRA(GRE)
3.	ALKIS SEMANUR(TUR)
5.	JABER RANA(MDA)
5.	AMALIA LUDVIG(ROU)
7.	PAPTAEODOROU IO EIRINI(GRE)

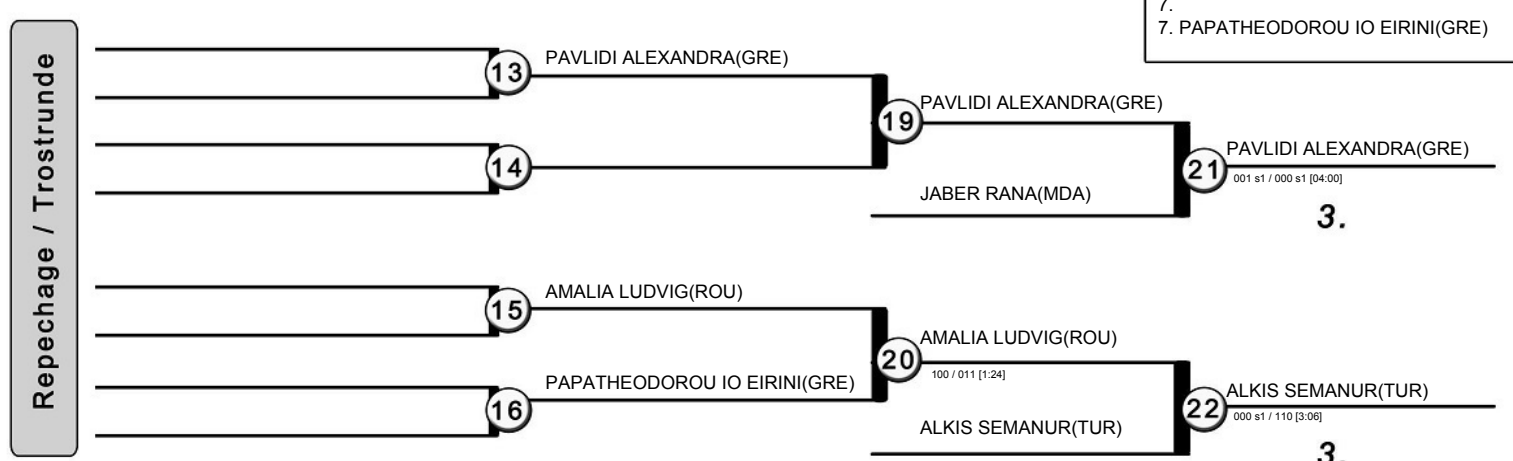



BALKAN JUDO ASSOCIATION
BALKAN JUDO CHAMPIONSHIP For CADETS (U18)
 May 09 - 10, 2026 - BUDVA, MONTENEGRO

48 KG
 13 Judoka

POOL A

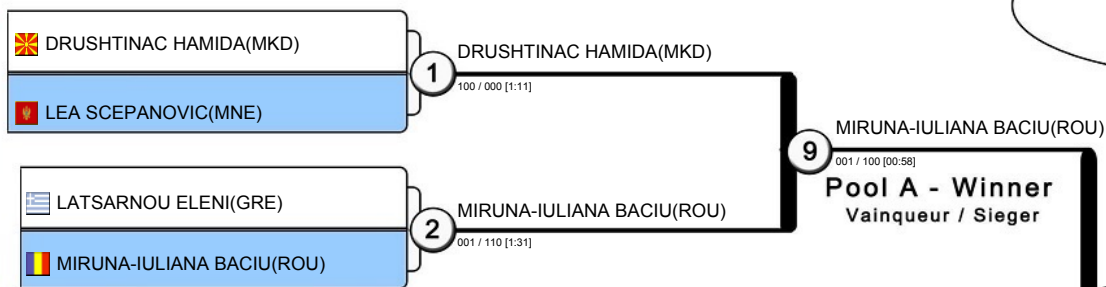

POOL B

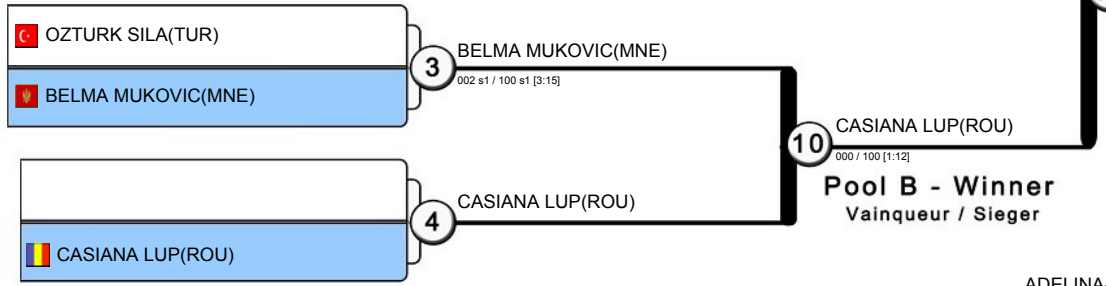

POOL C

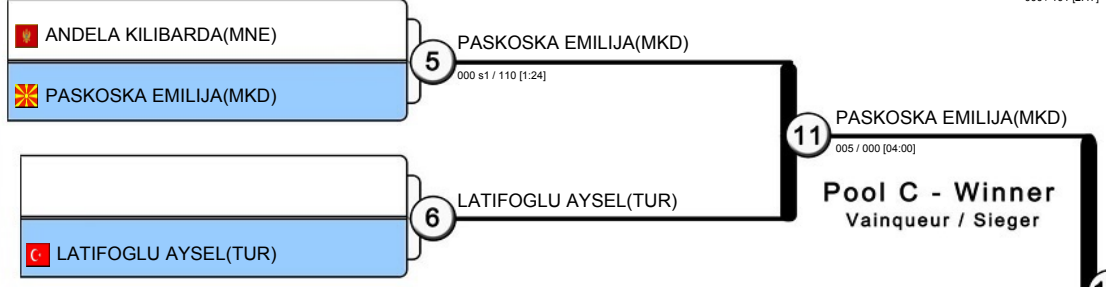

POOL D

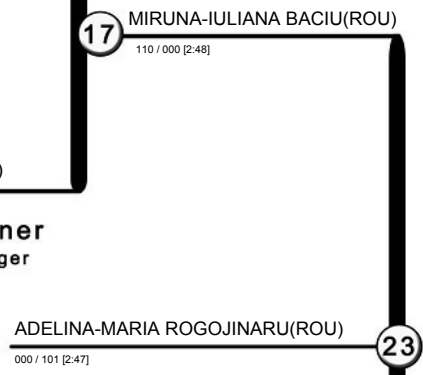
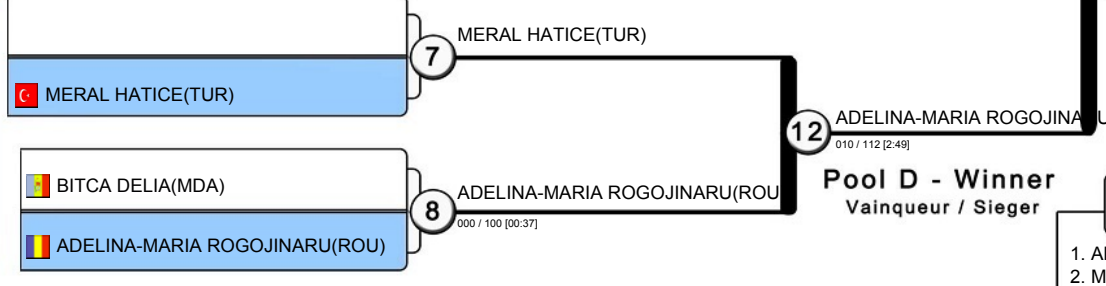

1.

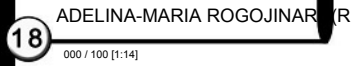

- Results**
 Resultat / Platzierungen
1. ADELINA-MARIA ROGOJINARU(ROU)
 2. MIRUNA-IULIANA BACIU(ROU)
 3. DRUSHTINAC HAMIDA(MKD)
 3. MERAL HATICE(TUR)
 5. PASKOSKA EMILIJA(MKD)
 5. CASIANA LUP(ROU)
 7. BELMA MUKOVIC(MNE)
 7. LATIFOGLU AYSEL(TUR)

Repechage / Trostrunde

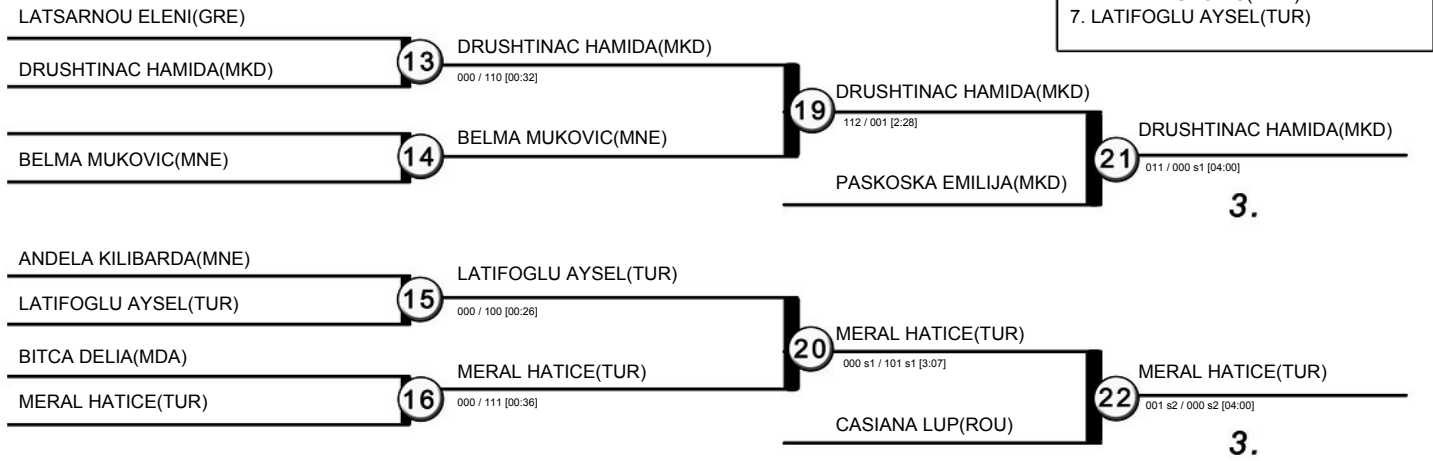

3.

3.



BALKAN JUDO ASSOCIATION

BALKAN JUDO CHAMPIONSHIP For CADETS (U18)

May 09 - 10, 2026 - BUDVA, MONTENEGRO

57 KG

24 Judoka

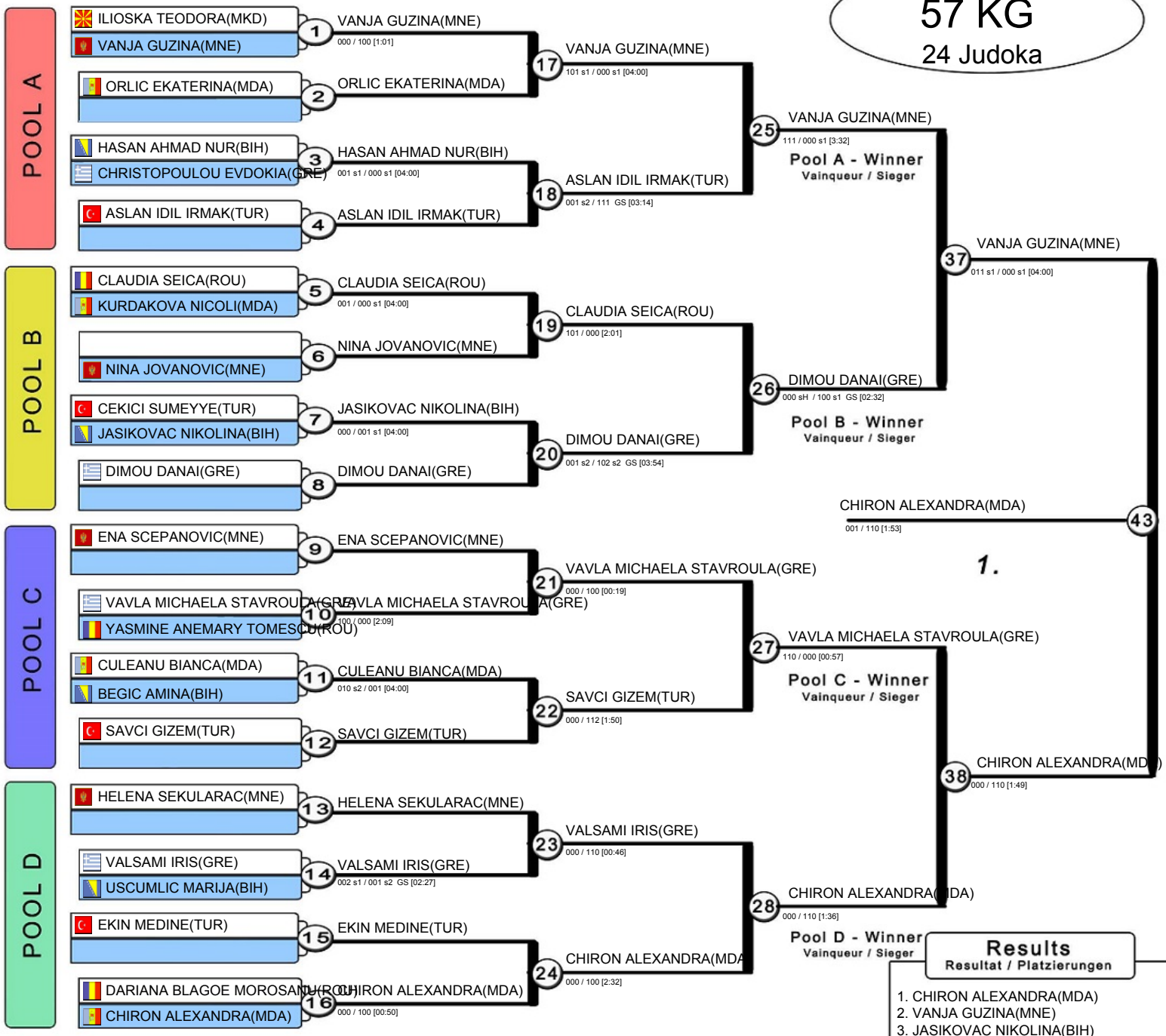

Results

Resultat / Platzierungen

1. CHIRON ALEXANDRA(MDA)
2. VANJA GUZINA(MNE)
3. JASIKOVAC NIKOLINA(BIH)
4. DIMOU DANAI(GRE)
5. VAVLA MICHAELA STAVROULA(GRE)
6. VALSAMI IRIS(GRE)
7. ASLAN IDIL IRMAK(TUR)
8. SAVCI GIZEM(TUR)

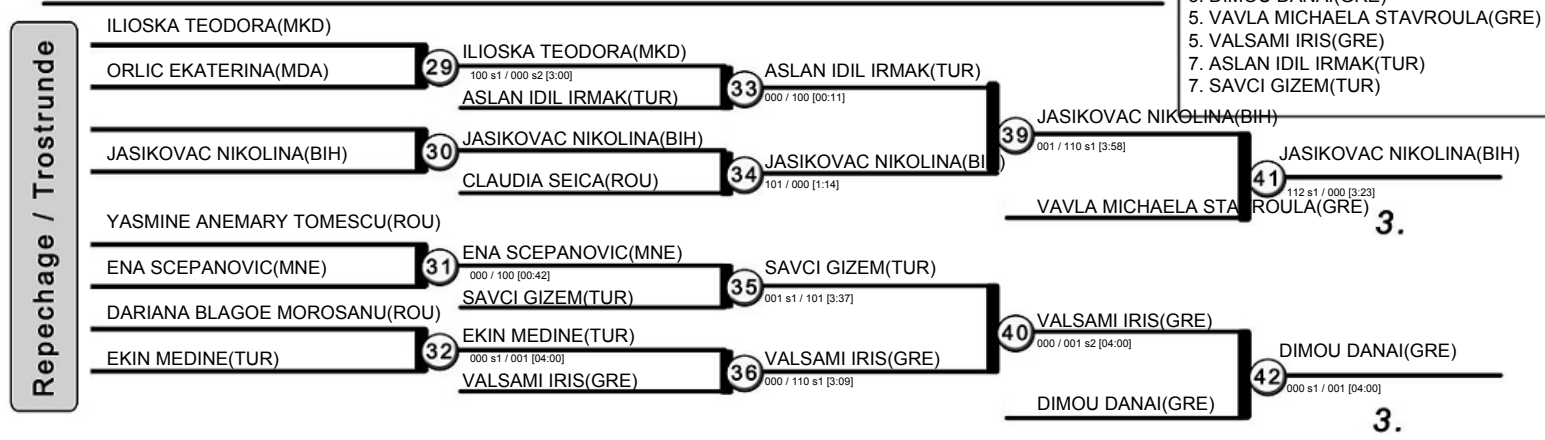



BALKAN JUDO ASSOCIATION

BALKAN JUDO CHAMPIONSHIP For CADETS (U18)

May 09 - 10, 2026 - BUDVA, MONTENEGRO

63 KG
22 Judoka

POOL A

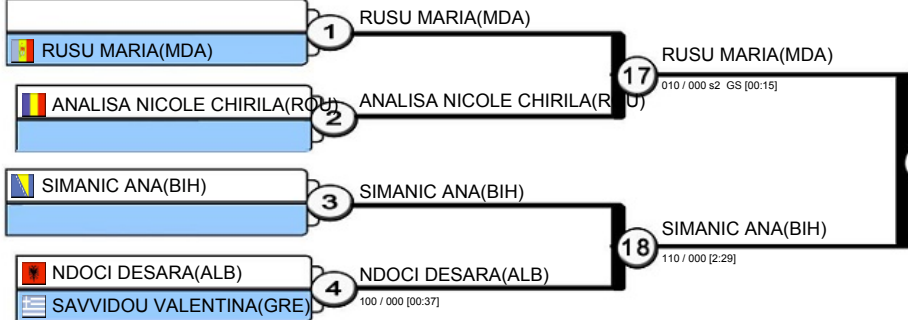

Pool A - Winner
Vainqueur / Sieger

POOL B

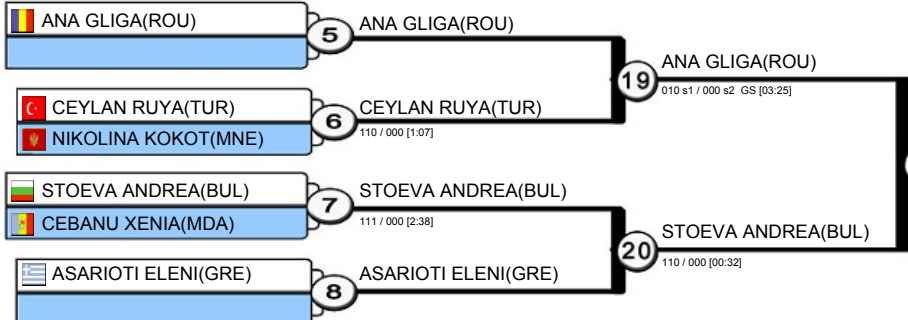

Pool B - Winner
Vainqueur / Sieger

POOL C

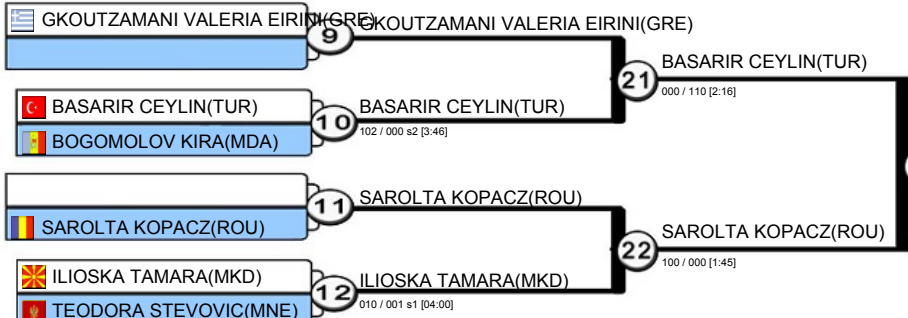

Pool C - Winner
Vainqueur / Sieger

POOL D

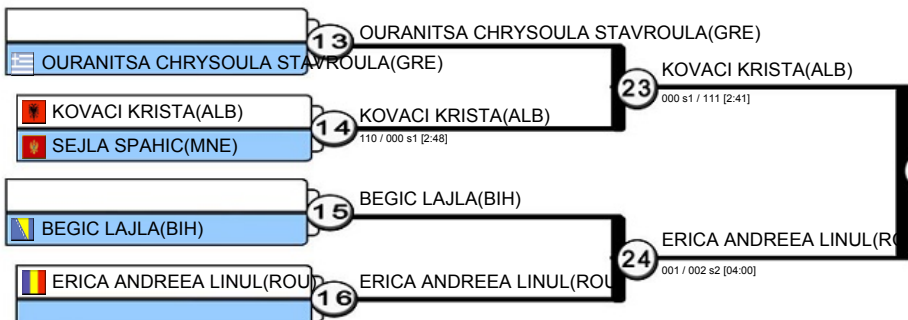

Pool D - Winner
Vainqueur / Sieger

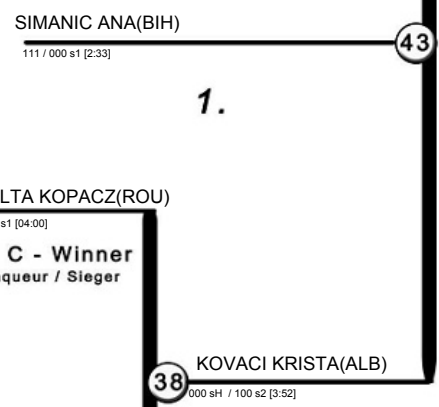

1.

2.

Results
Resultat / Platzierungen

1. SIMANIC ANA(BIH)
2. KOVACI KRISTA(ALB)
3. SAROLTA KOPACZ(ROU)
3. ANA GLIGA(ROU)
5. STOEVA ANDREA(BUL)
5. SEJLA SPAHIC(MNE)
7. NDOCI DESARA(ALB)
7. BASARIR CEYLIN(TUR)

Repechage / Trostrunde

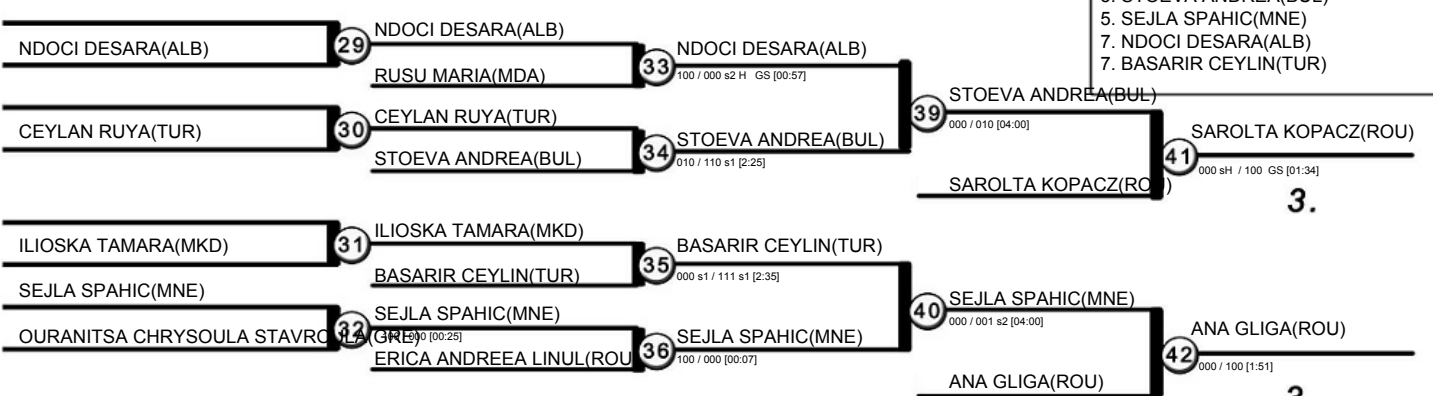

3.

3.



BALKAN JUDO ASSOCIATION
BALKAN JUDO CHAMPIONSHIP For CADETS (U18)
 May 09 - 10, 2026 - BUDVA, MONTENEGRO

70 KG
 19 Judoka

POOL A

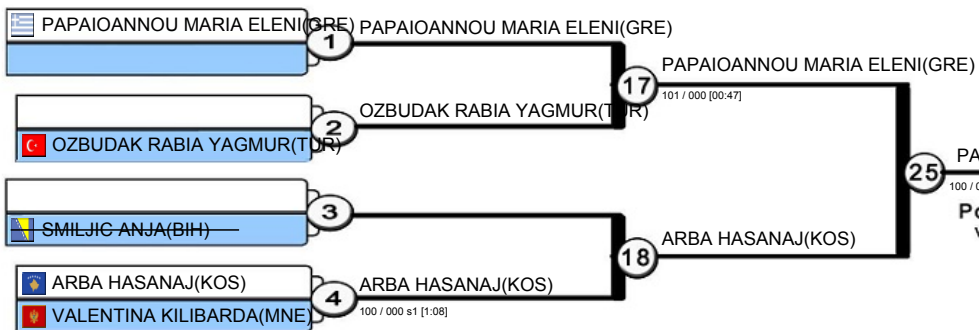

POOL B

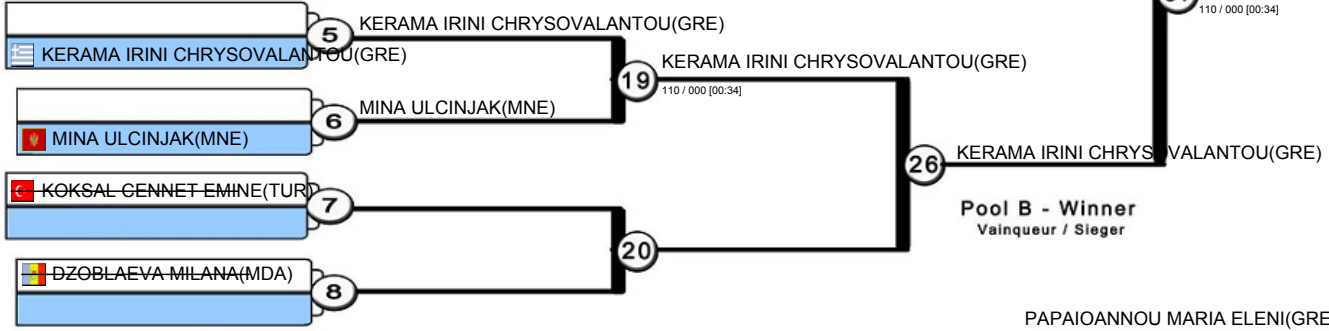

POOL C

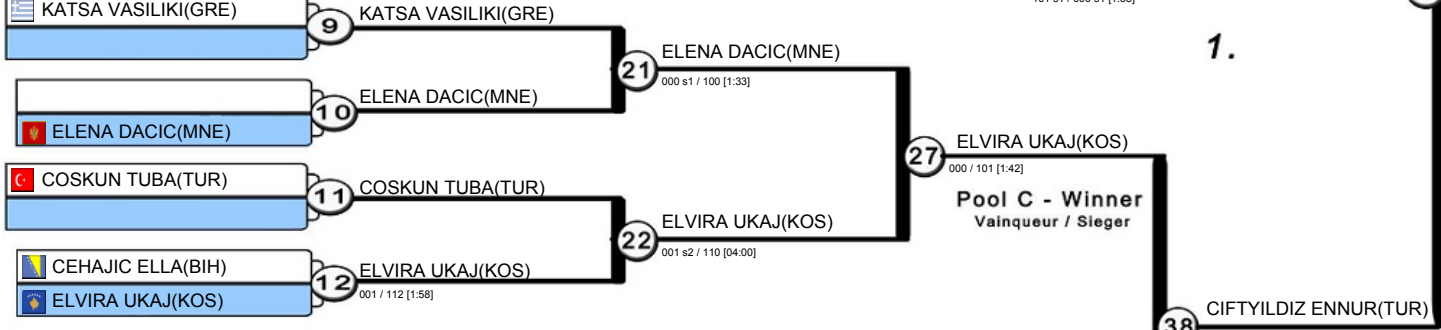

POOL D

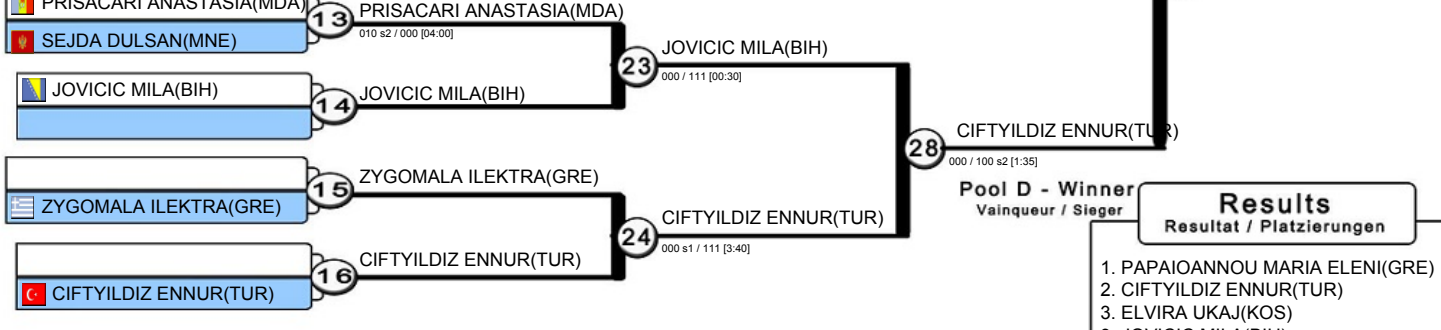

Repechage / Trostrunde

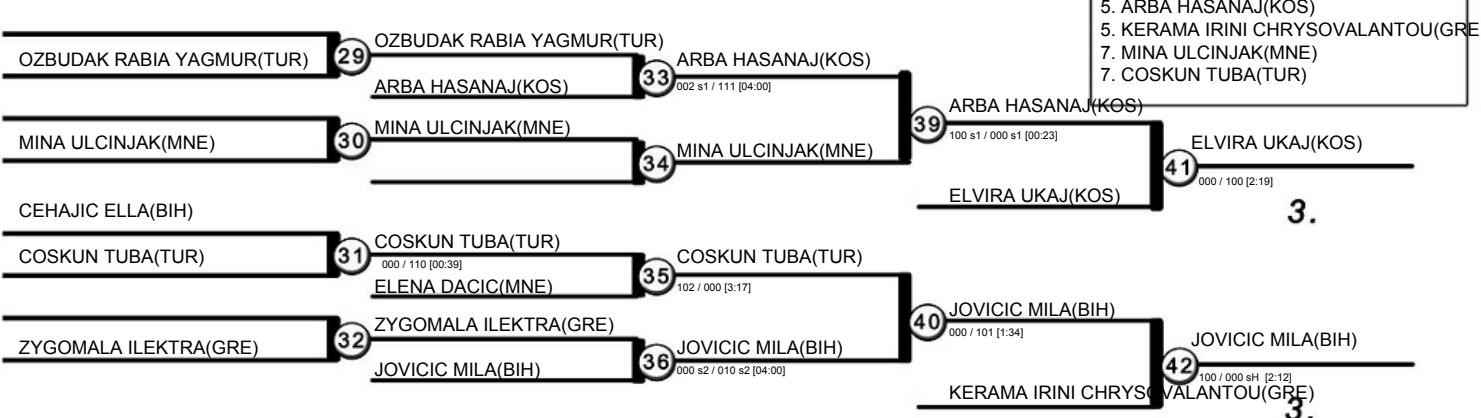

- 1.**
- 43 PAPAIOANNOU MARIA ELENI(GRE) [101 s1 / 000 s1 [1:38]]
- 38** CIFTYILDIZ ENNUR(TUR) [000 / 110 [2:22]]

- Results**
 Resultat / Platzierungen
1. PAPAIOANNOU MARIA ELENI(GRE)
 2. CIFTYILDIZ ENNUR(TUR)
 3. ELVIRA UKAJ(KOS)
 3. JOVICIC MILA(BIH)
 5. ARBA HASANAJ(KOS)
 5. KERAMA IRINI CHRYSOVALANTOU(GRE)
 7. MINA ULCINJAK(MNE)
 7. COSKUN TUBA(TUR)



BALKAN JUDO ASSOCIATION

BALKAN JUDO CHAMPIONSHIP For CADETS (U18)

May 09 - 10, 2026 - BUDVA, MONTENEGRO

+70 KG
17 Judoka

POOL A

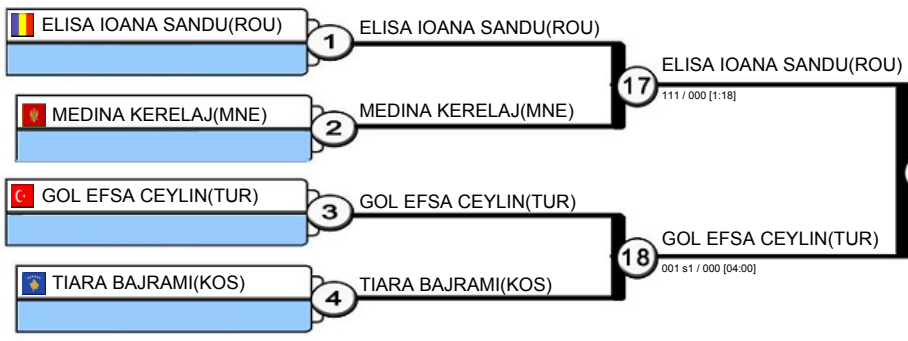

Pool A - Winner
Vainqueur / Sieger

POOL B

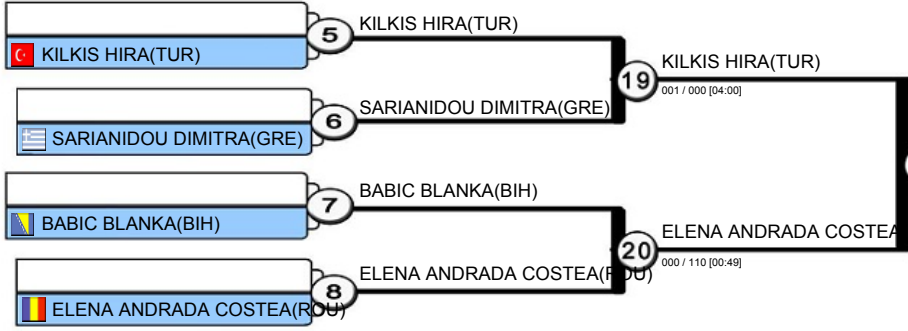

Pool B - Winner
Vainqueur / Sieger

POOL C

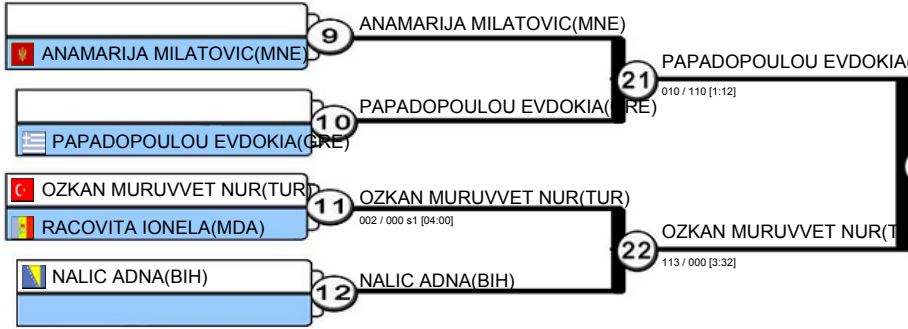

Pool C - Winner
Vainqueur / Sieger

POOL D

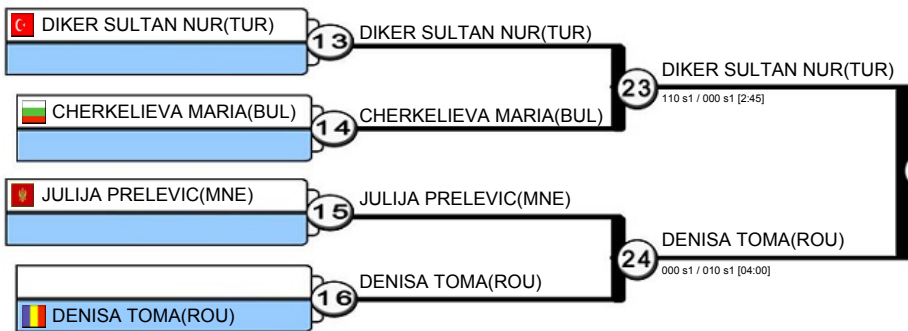

Pool D - Winner
Vainqueur / Sieger

Results
Resultat / Platzierungen

1. OZKAN MURUVVET NUR(TUR)
2. GOL EFSA CEYLIN(TUR)
3. DIKER SULTAN NUR(TUR)
5. SARIANIDOU DIMITRA(GRE)
5. CHERKELIEVA MARIA(BUL)
7. TIARA BAJRAMI(KOS)
7. PAPADOPOULOU EVDOKIA(GRE)

Repechage / Trostrunde

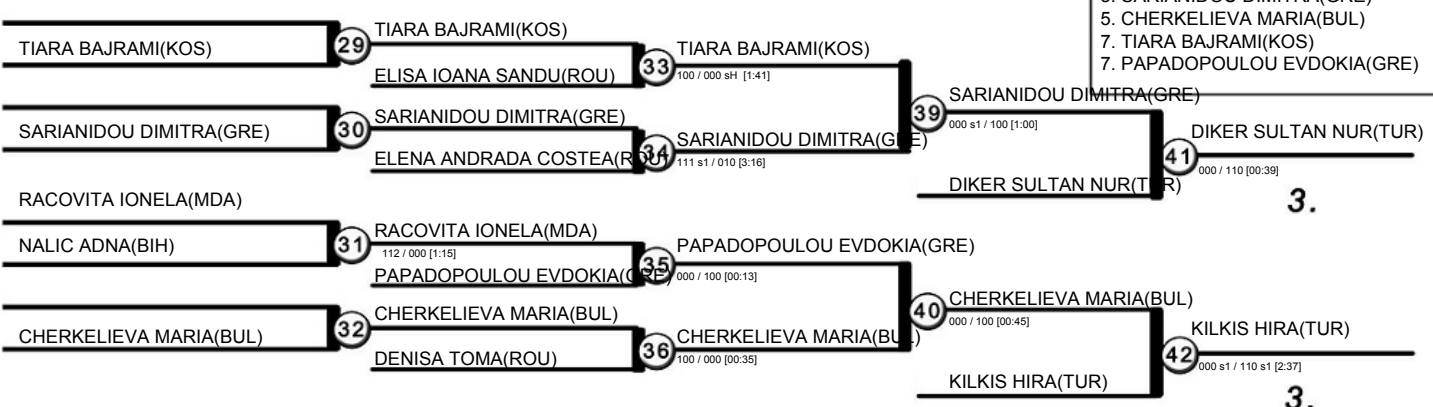



BALKAN JUDO ASSOCIATION

BALKAN JUDO CHAMPIONSHIP For CADETS (U18)

May 09 - 10, 2026 - BUDVA, MONTENEGRO

50 KG
20 Judoka

POOL A

1 MIDRIGAN BOGDAN(MDA) vs 17 MIDRIGAN BOGDAN(MDA) [110 / 000 s1 GS [01:57]]

2 HRISTOV DIAN(BUL) vs 18 CEBI KEREM(TUR) [000 / 101 [00:30]]

3 GOULAS DIMITRIOS(GRE) vs 19 MILAN BAROVIC(MNE) [010 s1 / 000 s1 [04:00]]

4 CEBI KEREM(TUR) vs 20 DRAGOS-ALEXANDRU POPA(ROU) [101 / 000 [1:15]]

25 CEBI KEREM(TUR)
Pool A - Winner
Vainqueur / Sieger

POOL B

5 MILAN BAROVIC(MNE) vs 21 SHULEKOV HRISTO(BUL) [000 s2 / 010 s2 GS [07:12]]

6 PLACHKOV VESELIN(BUL) vs 22 SPYROPOULOS VASILEIOS(GRE) [000 / 100 [2:19]]

7 DRAGOS-ALEXANDRU POPA(ROU) vs 23 GUN BERKAY(TUR) [010 / 000 s2 [04:00]]

8 MALAMOUSIS CHARILAOS(GRE) vs 24 VASILIJE MILASEVIC(MNE) [000 s1 / 002 s1 [04:00]]

26 DRAGOS-ALEXANDRU POPA(ROU)
Pool B - Winner
Vainqueur / Sieger

POOL C

9 IVANOV SORIN(MDA) vs 27 SHULEKOV HRISTO(BUL) [001 / 000 s2 GS [06:56]]

10 SHULEKOV HRISTO(BUL) vs 28 GUN BERKAY(TUR) [001 / 000 [04:00]]

11 BALSJA JAUKOVIC(MNE) vs 29 GOULAS DIMITRIOS(GRE) [000 s2 / 000 s1H GS [02:49]]

12 SPYROPOULOS VASILEIOS(GRE) vs 30 MALAMOUSIS CHARILAOS(GRE) [000 / 110 [1:42]]

27 SHULEKOV HRISTO(BUL)
Pool C - Winner
Vainqueur / Sieger

POOL D

13 GUN BERKAY(TUR) vs 31 IVANOV SORIN(MDA) vs 32 ARAPIS ORESTIS(GRE) vs 33 GOULAS DIMITRIOS(GRE)

14 ARAPIS ORESTIS(GRE) vs 34 MILAN BAROVIC(MNE)

15 TUDOR ALIN(ROU) vs 35 SPYROPOULOS VASILEIOS(GRE)

16 VASILIJE MILASEVIC(MNE) vs 36 VASILIJE MILASEVIC(MNE)

28 GUN BERKAY(TUR)
Pool D - Winner
Vainqueur / Sieger

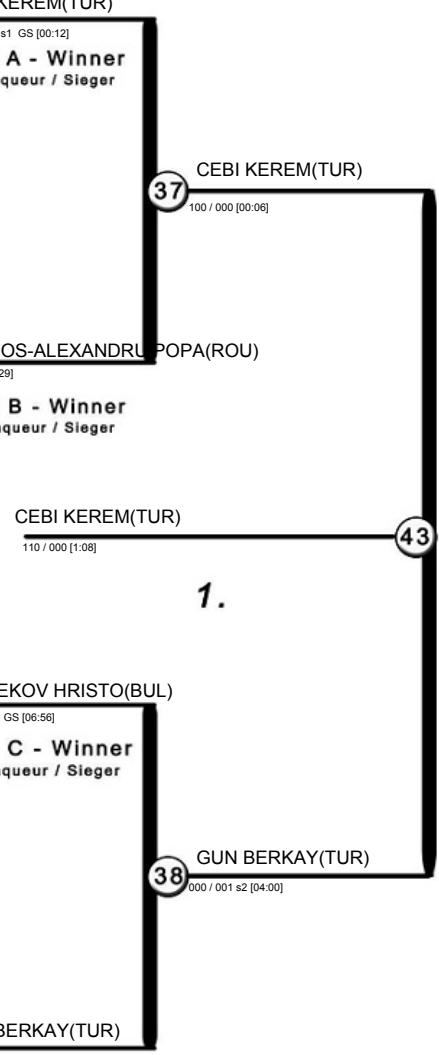

1.

38 GUN BERKAY(TUR) [000 / 001 s2 [04:00]]

Results
Resultat / Platzierungen

1. CEBI KEREM(TUR)
2. GUN BERKAY(TUR)
3. MILAN BAROVIC(MNE)
3. VASILIJE MILASEVIC(MNE)
5. SHULEKOV HRISTO(BUL)
5. DRAGOS-ALEXANDRU POPA(ROU)
7. GOULAS DIMITRIOS(GRE)
7. IVANOV SORIN(MDA)

Repechage / Trostrunde

29 GOULAS DIMITRIOS(GRE) vs 33 GOULAS DIMITRIOS(GRE) [100 s2 / 000 s1H GS [02:49]]

30 MALAMOUSIS CHARILAOS(GRE) vs 34 MILAN BAROVIC(MNE) [000 s1 / 110 [3:55]]

31 IVANOV SORIN(MDA) vs 35 SPYROPOULOS VASILEIOS(GRE) [101 / 000 [2:54]]

32 ARAPIS ORESTIS(GRE) vs 36 VASILIJE MILASEVIC(MNE) [000 s2 / 001 GS [00:36]]

39 MILAN BAROVIC(MNE)
39 MILAN BAROVIC(MNE) [000 / 010 s1 [04:00]]

40 VASILIJE MILASEVIC(MNE)
40 VASILIJE MILASEVIC(MNE) [000 / 001 s1 [04:00]]

41 MILAN BAROVIC(MNE)
41 MILAN BAROVIC(MNE) [001 s1 / 000 [04:00]]

42 VASILIJE MILASEVIC(MNE)
42 VASILIJE MILASEVIC(MNE) [010 / 001 s2 [04:00]]

3.

3.



BALKAN JUDO ASSOCIATION

BALKAN JUDO CHAMPIONSHIP For CADETS (U18)

May 09 - 10, 2026 - BUDVA, MONTENEGRO

60 KG
28 Judoka

POOL A

1	NIKOLA CELEBIC(MNE)	17	NIKOLA CELEBIC(MNE)
2	DEMIREZEN CINAR(TUR)	25	NIKOLA CELEBIC(MNE)
3	ROTSOS THEODOROS PETROS(GRE)	18	ROTSOS THEODOROS PETROS(GRE)
4	NICOLAEV PLATON(MDA)	26	MAVRODIN ALEXANDR(MDA)

Pool A - Winner
Vainqueur / Sieger

POOL B

5	NIKOLOV ALEKSANDAR(BUL)	19	SFIRIDIS GEORGIOS(GRE)
6	SFIRIDIS GEORGIOS(GRE)	20	MAVRODIN ALEXANDR(MDA)
7	LAZAR LAZAREVIC(BIH)	27	HRISTOV EMO(BUL)
8	MAVRODIN ALEXANDR(MDA)	28	TUZLUCOV ALEXANDRU(MDA)

Pool B - Winner
Vainqueur / Sieger

POOL C

9	MATEJ MILIC(MNE)	21	HRISTOV EMO(BUL)
10	HRISTOV EMO(BUL)	22	JON HAXHIU(KOS)
11	MUNTEANU MAXIM(MDA)	23	TUZLUCOV ALEXANDRU(MDA)
12	JON HAXHIU(KOS)	24	BALSA SINDIC(MNE)

Pool C - Winner
Vainqueur / Sieger

POOL D

13	KOLEV DANIEL(BUL)	23	TUZLUCOV ALEXANDRU(MDA)
14	TUZLUCOV ALEXANDRU(MDA)	28	TUZLUCOV ALEXANDRU(MDA)
15	CURLIC DAVID(BIH)	24	BALSA SINDIC(MNE)
16	BALSA SINDIC(MNE)	29	DEMIREZEN CINAR(TUR)

Pool D - Winner
Vainqueur / Sieger

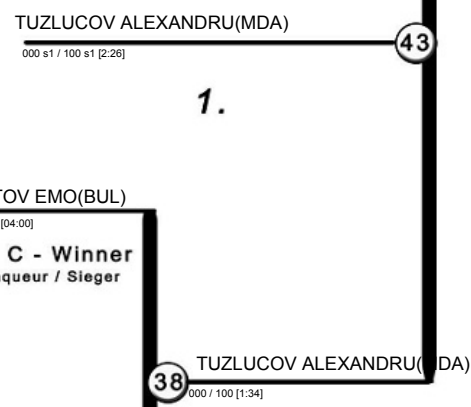

1.

38

Results
Resultat / Platzierungen

1. TUZLUCOV ALEXANDRU(MDA)
2. MAVRODIN ALEXANDR(MDA)
3. HRISTOV EMO(BUL)
5. ROTOS THEODOROS PETROS(GRE)
5. KOLEV DANIEL(BUL)
7. KAYMAK HAKAN(TUR)
7. MATEJ MILIC(MNE)

Repechage / Trostrunde

29	DEMIREZEN CINAR(TUR)	33	ROTSOS THEODOROS PETROS(GRE)
30	KAYMAK HAKAN(TUR)	34	KAYMAK HAKAN(TUR)
31	MATEJ MILIC(MNE)	35	MATEJ MILIC(MNE)
32	KOLEV DANIEL(BUL)	36	KOLEV DANIEL(BUL)

Pool A - Winner
Vainqueur / Sieger

Pool B - Winner
Vainqueur / Sieger

3.

3.



BALKAN JUDO ASSOCIATION

BALKAN JUDO CHAMPIONSHIP For CADETS (U18)

May 09 - 10, 2026 - BUDVA, MONTENEGRO

66 KG
28 Judoka

POOL A

1	DADEMIR ALPER(TUR)	17	POSNAKIDIS THEODOROS(GRE)
2	POSNAKIDIS THEODOROS(GRE)	18	MOGA VLAD(MDA)
3	KAMBERI FLAVJO(ALB)	19	OGNJEN RADOSEVIC(MNE)
4	MOGA VLAD(MDA)	20	GORCEAC OLEG(MDA)
5	TODOROV ZLATOMIR(BUL)	21	MILOT GASHI(KOS)
6	DURDEVIC KRISTIYAN(BIH)	22	NIKOLA PEROVIC(MNE)

Pool A - Winner
Vainqueur / Sieger

POOL B

5	KRISZTIAN KOKA(ROU)	19	OGNJEN RADOSEVIC(MNE)
6	OGNJEN RADOSEVIC(MNE)	20	GORCEAC OLEG(MDA)
7	NGUEN KRISTIYAN(BUL)	21	MILOT GASHI(KOS)
8	KOCA TARIK(TUR)	22	NIKOLA PEROVIC(MNE)
9	GORCEAC OLEG(MDA)	23	DIMITRAKAS PANAGIOTIS(GRE)
10	KUSES HAMZA(BIH)	24	APOSTOLOV MIHAIL(BUL)
11	ZAIMIDIS PETROS(GRE)	25	MILOT GASHI(KOS)
12	ZAIMIDIS PETROS(GRE)	26	OGNJEN RADOSEVIC(MNE)

Pool B - Winner
Vainqueur / Sieger

POOL C

9	MILOT GASHI(KOS)	21	MILOT GASHI(KOS)
10	CETIN ISA(TUR)	22	NIKOLA PEROVIC(MNE)
11	LAZAR VUJICIC(BIH)	23	DIMITRAKAS PANAGIOTIS(GRE)
12	VLAD MIHAI SIMON(ROU)	24	APOSTOLOV MIHAIL(BUL)
13	NIKOLA PEROVIC(MNE)	25	MILOT GASHI(KOS)
14	KIURTZIDIS ANASTASIOS STANISLAV(GRE)	26	OGNJEN RADOSEVIC(MNE)
15	TOLCACI IVAN(MDA)	27	MILOT GASHI(KOS)

Pool C - Winner
Vainqueur / Sieger

POOL D

13	DAVID BALAN(ROU)	23	DIMITRAKAS PANAGIOTIS(GRE)
14	SANDU MAXIM(MDA)	24	APOSTOLOV MIHAIL(BUL)
15	DIMITRAKAS PANAGIOTIS(GRE)	25	MILOT GASHI(KOS)
16	ALAN MERULIC(MNE)	26	OGNJEN RADOSEVIC(MNE)
17	DABIC IVAN(BIH)	27	MILOT GASHI(KOS)
18	APOSTOLOV MIHAIL(BUL)	28	APOSTOLOV MIHAIL(BUL)
19	TEKIN SULEYMAN(TUR)	29	TODOROV ZLATOMIR(BUL)

Pool D - Winner
Vainqueur / Sieger

MILOT GASHI(KOS) 43

1.

MILOT GASHI(KOS) 38

Results
Resultat / Platzierungen

1. MILOT GASHI(KOS)
2. MOGA VLAD(MDA)
3. APOSTOLOV MIHAIL(BUL)
5. NGUEN KRISTIYAN(BUL)
5. NIKOLA PEROVIC(MNE)
7. POSNAKIDIS THEODOROS(GRE)
7. DIMITRAKAS PANAGIOTIS(GRE)

Repechage / Trostrunde

29	TODOROV ZLATOMIR(BUL)	33	POSNAKIDIS THEODOROS(GRE)
30	NGUEN KRISTIYAN(BUL)	34	GORCEAC OLEG(MDA)
31	CETIN ISA(TUR)	35	NIKOLA PEROVIC(MNE)
32	TEKIN SULEYMAN(TUR)	36	DIMITRAKAS PANAGIOTIS(GRE)
33	POSNAKIDIS THEODOROS(GRE)	39	NGUEN KRISTIYAN(BUL)
34	GORCEAC OLEG(MDA)	40	NIKOLA PEROVIC(MNE)
35	NIKOLA PEROVIC(MNE)	41	APOSTOLOV MIHAIL(BUL)
36	DIMITRAKAS PANAGIOTIS(GRE)	42	OGNJEN RADOSEVIC(MNE)

3.

3.



BALKAN JUDO ASSOCIATION

BALKAN JUDO CHAMPIONSHIP For CADETS (U18)

May 09 - 10, 2026 - BUDVA, MONTENEGRO

73 KG
28 Judoka

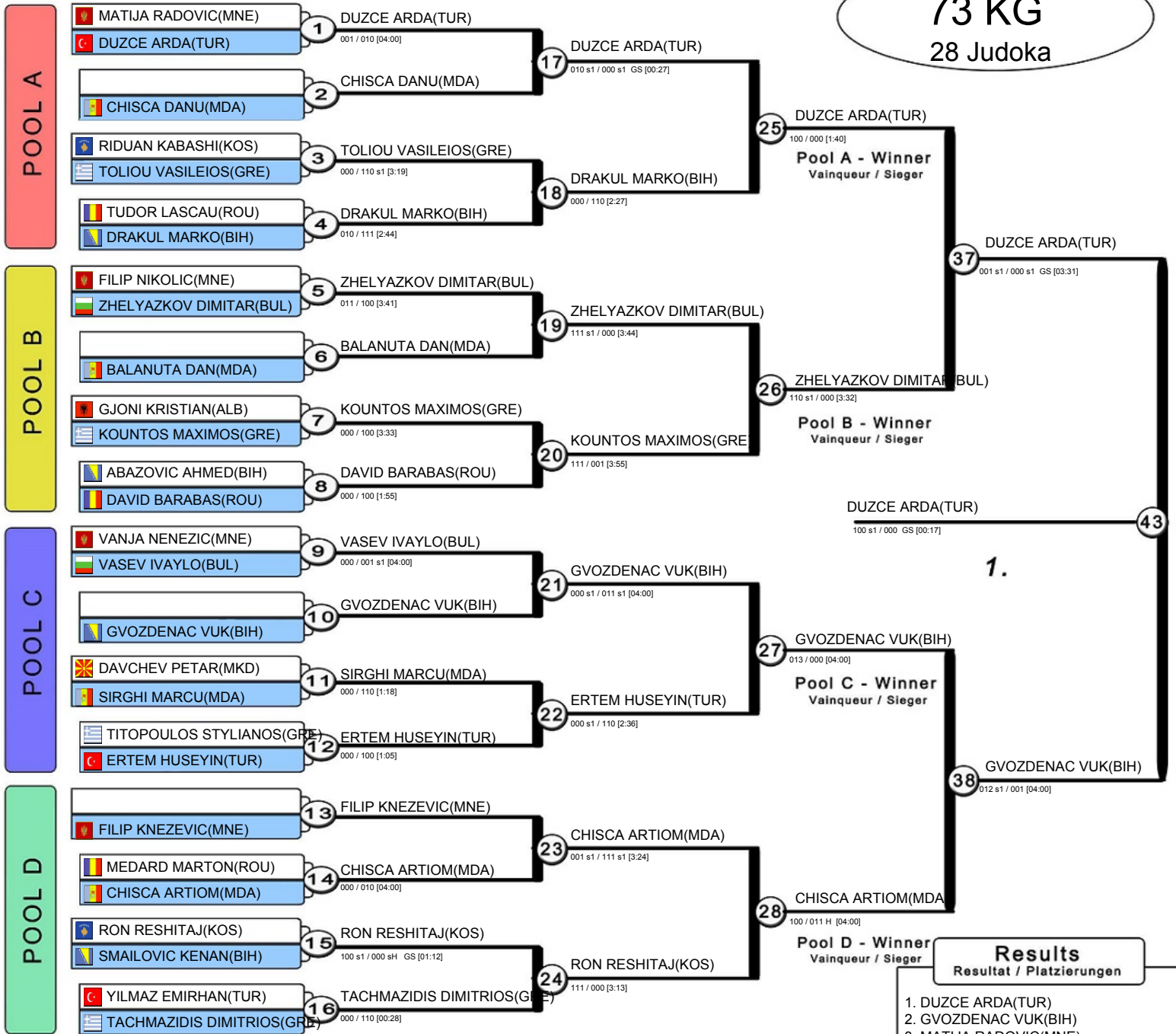

Results

Resultat / Platzierungen

1. DUZCE ARDA(TUR)
2. GVOZDENAC VUK(BIH)
3. MATIJA RADOVIC(MNE)
4. ZHELJAZKOV DIMITAR(BUL)
5. CHISCA ARTIOM(MDA)
6. ERTEM HUSEYIN(TUR)
7. BALANUTA DAN(MDA)
8. FILIP KNEZEVIC(MNE)

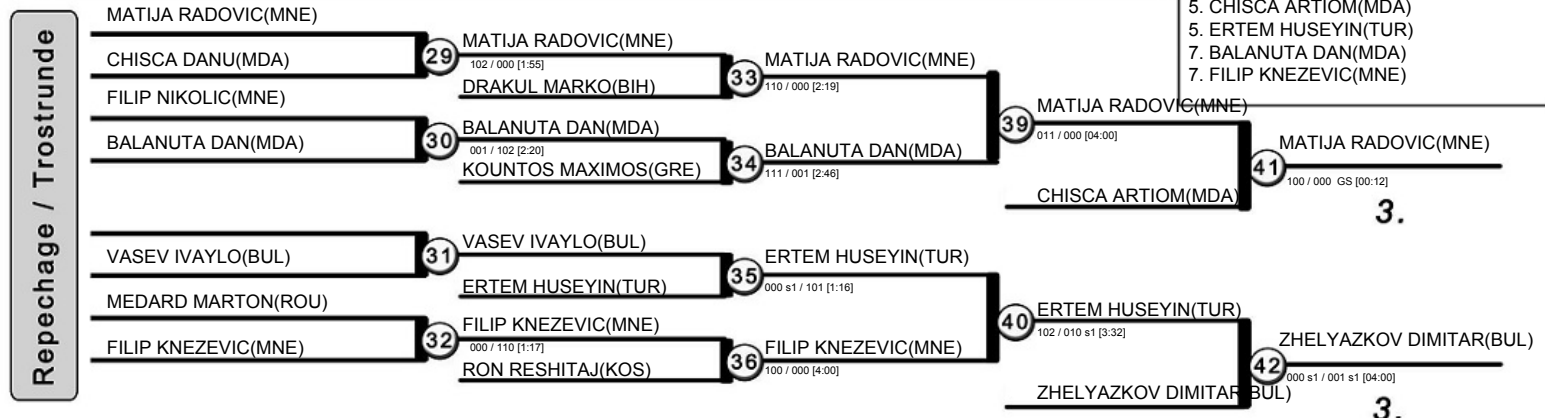



BALKAN JUDO ASSOCIATION

BALKAN JUDO CHAMPIONSHIP For CADETS (U18)

May 09 - 10, 2026 - BUDVA, MONTENEGRO

81 KG

25 Judoka

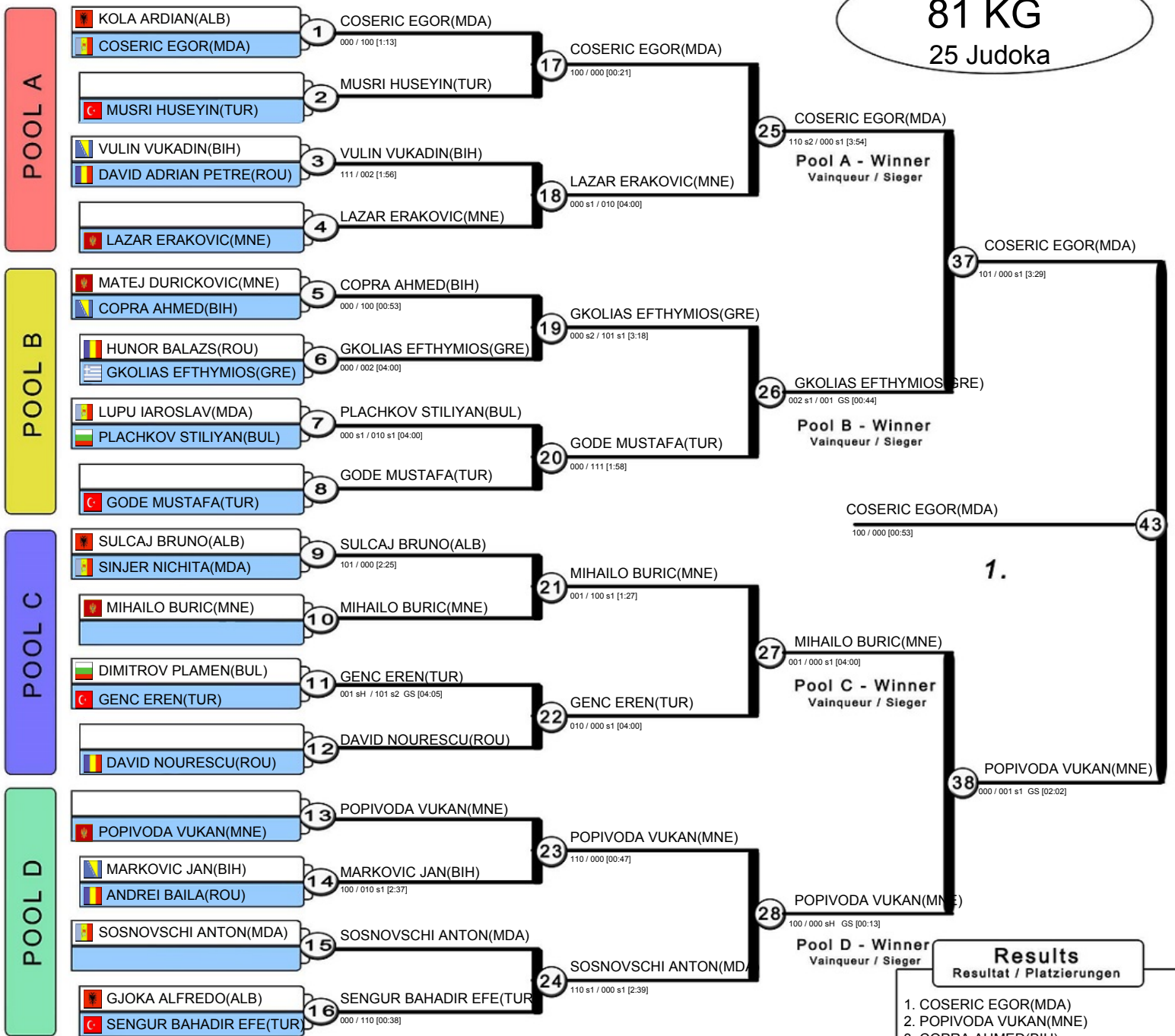

Results

Resultat / Platzierungen

1. COSERIC EGOR (MDA)
2. POPIVODA VUKAN (MNE)
3. COPRA AHMED (BIH)
3. GKOLIAS EFTHYMOS (GRE)
5. MIHAILO BURIC (MNE)
7. LAZAR ERAKOVIC (MNE)
7. MARKOVIC JAN (BIH)

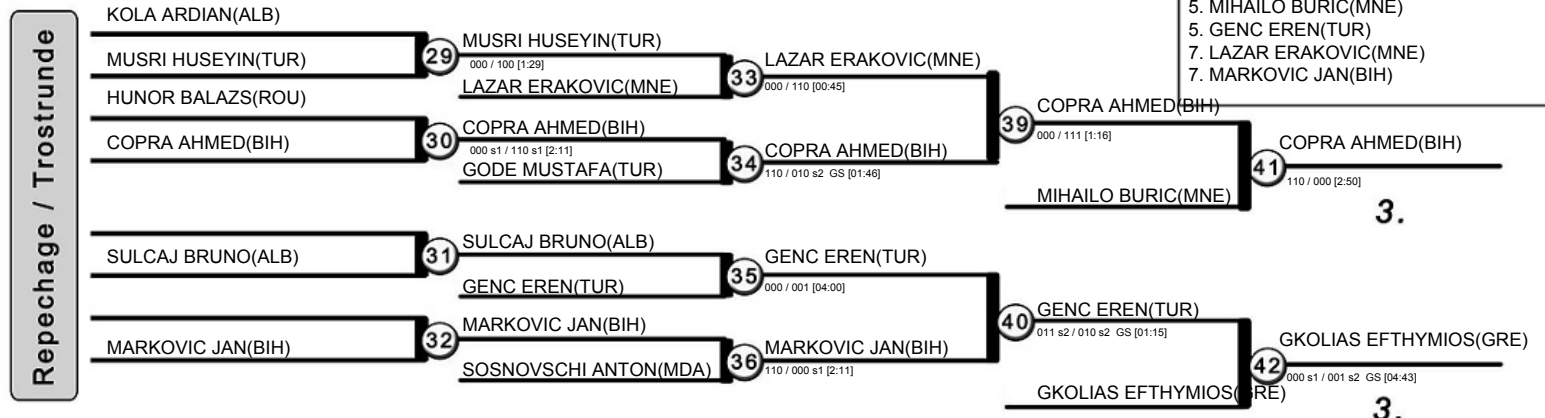



BALKAN JUDO ASSOCIATION
BALKAN JUDO CHAMPIONSHIP For CADETS (U18)
 May 09 - 10, 2026 - BUDVA, MONTENEGRO

+90 KG
 17 Judoka

POOL A

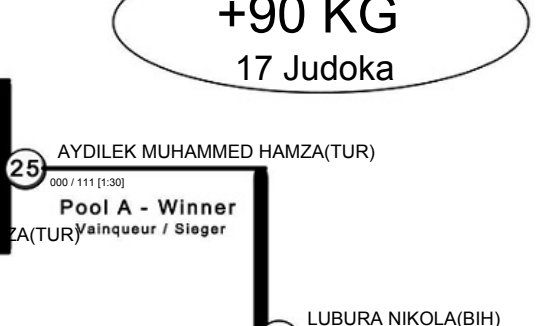
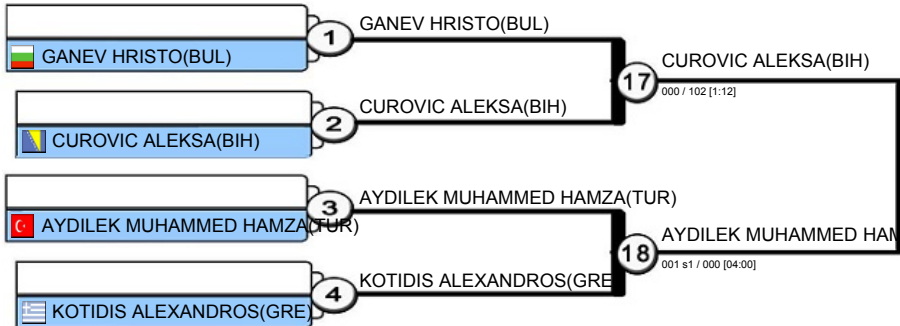

POOL B

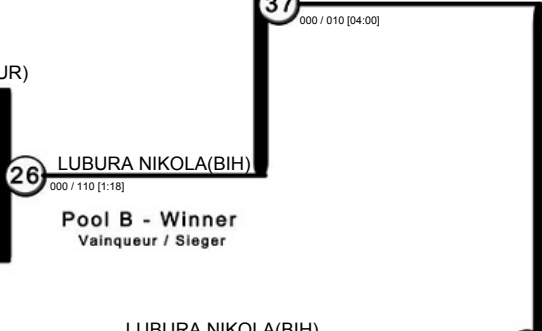
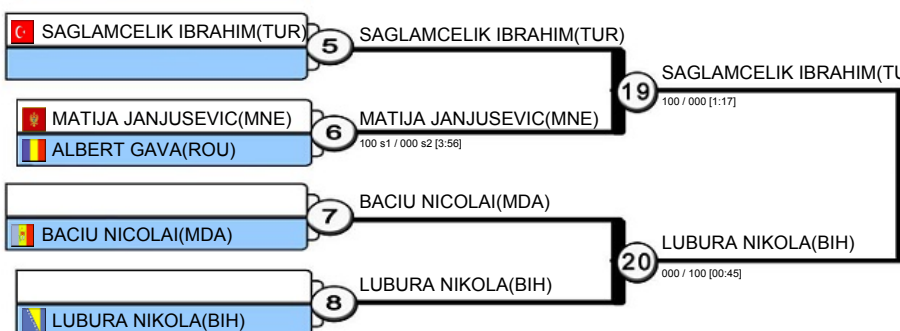

POOL C

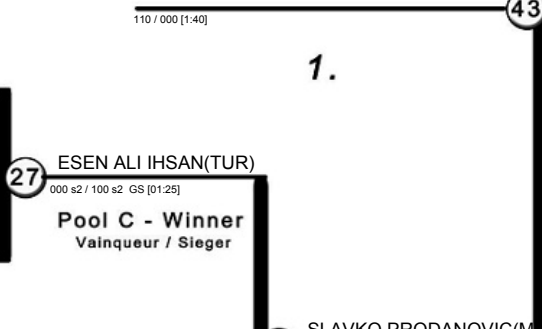
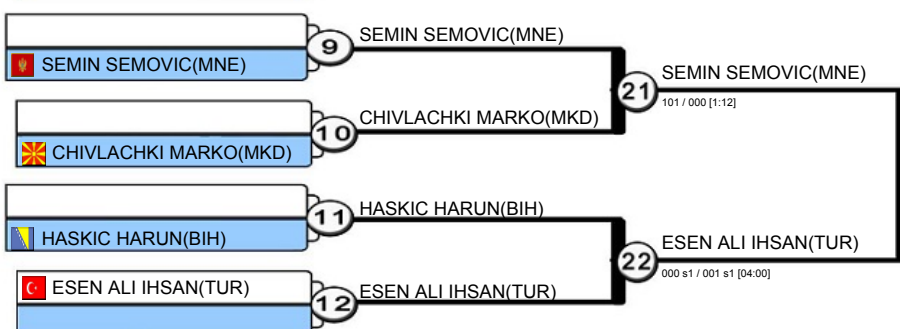

POOL D

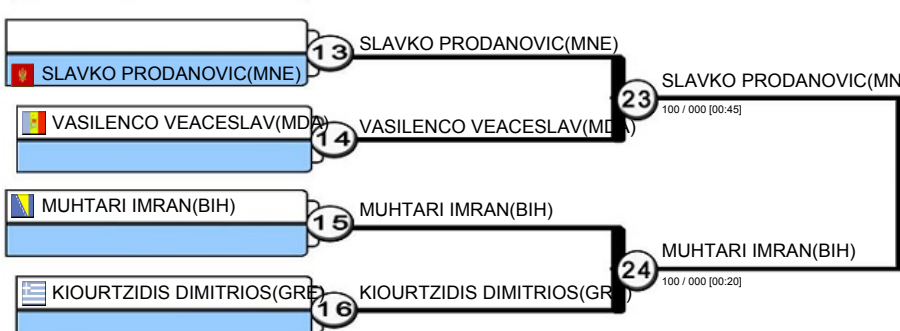

Results
 Resultat / Platzierungen

- LUBURA NIKOLA (BIH)
- SLAVKO PRODANOVIC (MNE)
- CUROVIC ALEKSA (BIH)
- MUHTARI IMRAN (BIH)
- ESEN ALI IHSAN (TUR)
- AYDILEK MUHAMMED HAMZA (TUR)
- SAGLAMCELIK IBRAHIM (TUR)
- SEMIN SEMOVIC (MNE)

Repechage / Trostrunde

