



Tbilisi Millennium Team Cadet European Cup 2025

Georgia, Tbilisi, 12-13 Apr 2025

-50 kg

Men (17)

POOL A

	BOLKVADZE Saba	GEO	1	BOLKVADZE S. (GEO)
	DAVTYAN Narek	ARM	2	DAVTYAN N. (ARM)
	UMAROV Bilol	TJK	3	UMAROV B. (TJK)
	SEN Eymen	TUR	4	SEN E. (TUR)

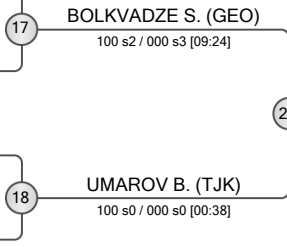

POOL B

	DVALI Giorgi	GEO	5	DVALI G. (GEO)
	STEKANOV Gleb	IJF	6	STEKANOV G. (IJF)
	KHARIBEGASHVILI Daviti	GEO	7	KHARIBEGASHVILI D. (GEO)
	MENGNIBOEV Hazratbek	TJK	8	MENGNIBOEV H. (TJK)

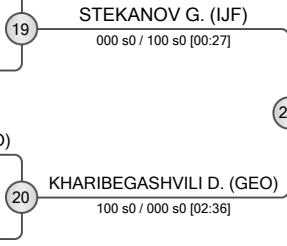

POOL C

	DVALISHVILI Arsen	GEO	9	DVALISHVILI A. (GEO)
	YADGAROV Sardor	UZB	10	YADGAROV S. (UZB)
	TOPTYGIN Iliia	IJF	11	TOPTYGIN I. (IJF)
	NOZADZE Saba	GEO	12	NOZADZE S. (GEO)

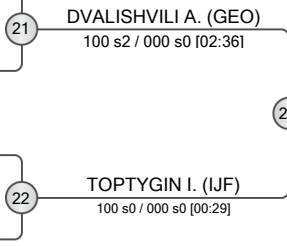

POOL D

	KHALILLI Rza	AZE	13	KHALILLI R. (AZE)
	NIKOLASHVILI Giorgi	GEO	14	AZIMOV M. (TJK)
	AZIMOV Muslim	TJK	14	000 s0 / 011 s1 [04:00]
	KILINC Hamza	TUR	15	KILINC H. (TUR)
	BABONETS Artem	IJF	16	BABONETS A. (IJF)

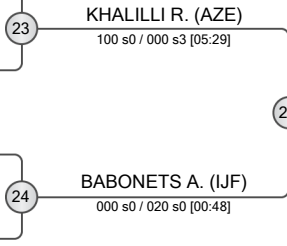

REPECHAGE

29	DAVTYAN N. (ARM)	33	UMAROV B. (TJK)	33	DAVTYAN N. (ARM)
30	MENGNIBOEV H. (TJK)	34	STEKANOV G. (IJF)	34	STEKANOV G. (IJF)
31	NOZADZE S. (GEO)	35	DVALISHVILI A. (GEO)	35	NOZADZE S. (GEO)
32	KILINC H. (TUR)	36	KHALILLI R. (AZE)	36	KHALILLI R. (AZE)

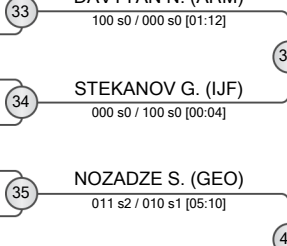

FINAL RESULTS		
1.	TOPTYGIN Iliia	IJF
2.	BOLKVADZE Saba	GEO
3.	BABONETS Artem	IJF
3.	KHALILLI Rza	AZE
5.	STEKANOV Gleb	IJF
7.	KHARIBEGASHVILI Daviti	GEO
7.	DAVTYAN Narek	ARM
7.	NOZADZE Saba	GEO





Tbilisi Millennium Team Cadet European Cup 2025

Georgia, Tbilisi, 12-13 Apr 2025

-55 kg

Men (22)

POOL A

	GASIMZADE Rustam	AZE	1	GASIMZADE R. (AZE)
	MEGRELISHVILI Nika	GEO	2	MEGRELISHVILI N. (GEO)
	STOYANOV Mihail	BUL	3	STOYANOV M. (BUL)
	NASKIDASHVILI Gela	GEO	4	SARKISIAN A. (IJF)
	SARKISIAN Artur	IJF	4	SARKISIAN A. (IJF)

POOL B

	MAHMADSHARIFOV Haidar	TJK	5	MAHMADSHARIFOV H. (TJK)
	DVALIDZE Dachi	GEO	6	DVALIDZE D. (GEO)
	GART Lidor	ISR	7	HUSEYNLI J. (AZE)
	HUSEYNLI Jeyhun	AZE	7	HUSEYNLI J. (AZE)
	TUMONBAEV Marsel	KGZ	8	TUMONBAEV M. (KGZ)
	HOVHANNISYAN Vahe	ARM	8	TUMONBAEV M. (KGZ)

POOL C

	ROLNIK Gali	ISR	9	ROLNIK G. (ISR)
	MIRZOEV Mukhammaddzhon	TJK	10	LAISHRAM L. (IND)
	LAISHRAM Lucky	IND	10	LAISHRAM L. (IND)
	NAHAPETYAN Shavarsh	ARM	11	NAHAPETYAN S. (ARM)
	MEBAGISHVILI Giorgi	GEO	12	MEBAGISHVILI G. (GEO)

POOL D

	SHIKHIZADA Nijat	AZE	13	SHIKHIZADA N. (AZE)
	TOPTYGIN Aleksei	IJF	14	TOPTYGIN A. (IJF)
	PALELASHVILI Nikoloz	GEO	15	ASIRLI B. (TUR)
	ASIRLI Bilal Efe	TUR	15	ASIRLI B. (TUR)
	BURKHONOV Khushnudbek	UZB	16	BURKHONOV K. (UZB)
	KUSNEZOV Yaniv	ISR	16	BURKHONOV K. (UZB)

REPECHAGE

29	STOYANOV M. (BUL)	33	GASIMZADE R. (AZE)
30	DVALIDZE D. (GEO)	34	HUSEYNLI J. (AZE)
31	MEBAGISHVILI G. (GEO)	35	ROLNIK G. (ISR)
32	PALELASHVILI N. (GEO)	36	BURKHONOV K. (UZB)
	SHIKHIZADA N. (AZE)		BURKHONOV K. (UZB)

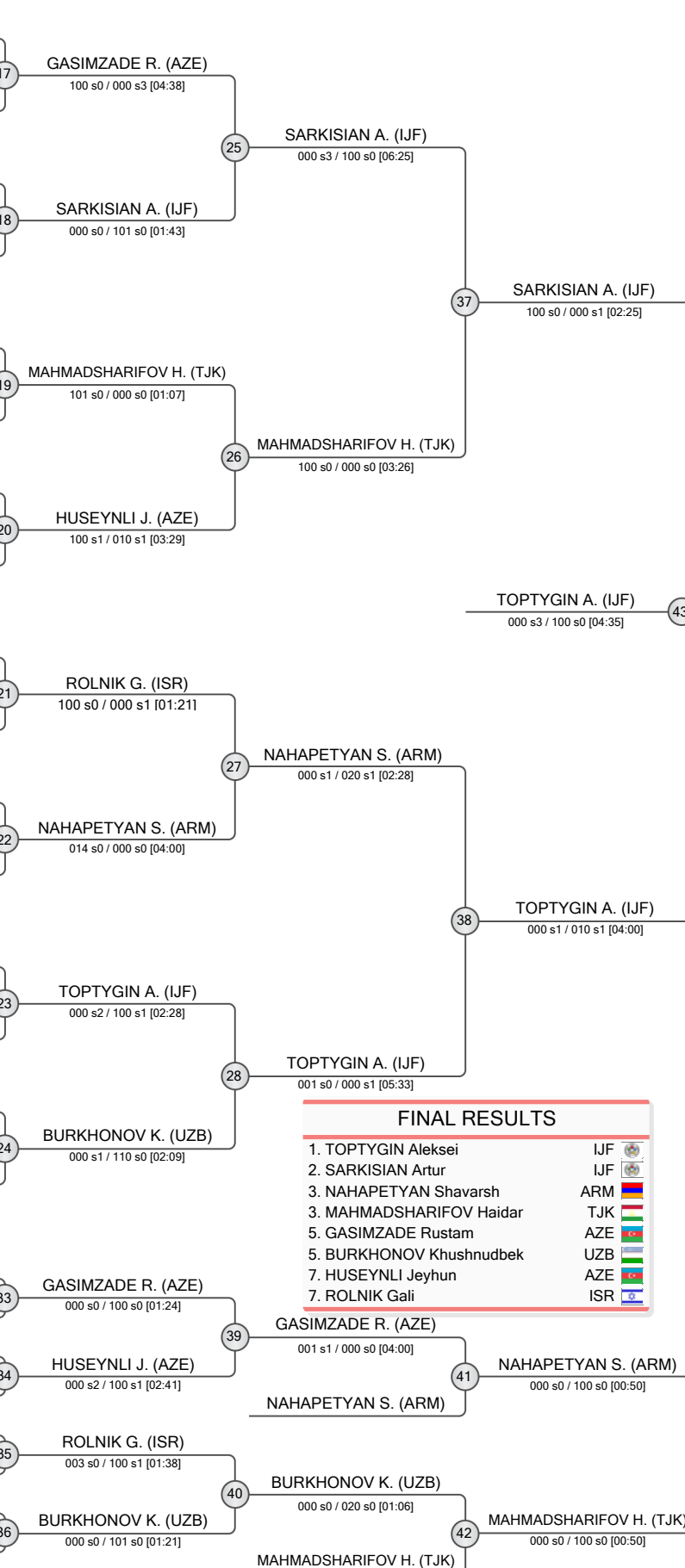

FINAL RESULTS

1. TOPTYGIN Aleksei (IJF)
2. SARKISIAN Artur (IJF)
3. NAHAPETYAN Shavarsh (ARM)
3. MAHMADSHARIFOV Haidar (TJK)
5. GASIMZADE Rustam (AZE)
5. BURKHONOV Khushnudbek (UZB)
7. HUSEYNLI Jeyhun (AZE)
7. ROLNIK Gali (ISR)





Tbilisi Millennium Team Cadet European Cup 2025

Georgia, Tbilisi, 12-13 Apr 2025

-60 kg

Men (37)

POOL A

	ALASGAROV Zeyd	AZE
	JANGIRYAN Khachatur	ARM
	KHAKDOTOV Khasan	TJK
	NITSAN Boaz	ISR
	MEREKLISHVILI Levan	GEO
	GEGIA Giorgi	GEO
	OHRENSTEIN Yehonatan	ISR
	ISMAILOV Rabadan	IJF
	NOSIROV Mukhammadkarim	UZB

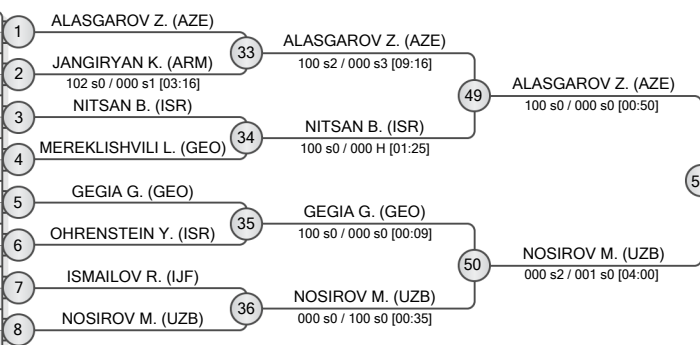

POOL B

	AZARUMYAN Artak	EST
	CHADUNELI Borisi	GEO
	BARNATAN Ori	ISR
	HMAYAKYAN Garnik	ARM
	TERENTEV Matvei	IJF
	KAPANADZE Giorgi	GEO
	SHIDLANSIK Ido	ISR
	SAYIK Kerem	TUR
	MOUSIKOS Nikolas	CYP
	BUSURASHVILI Goga	GEO

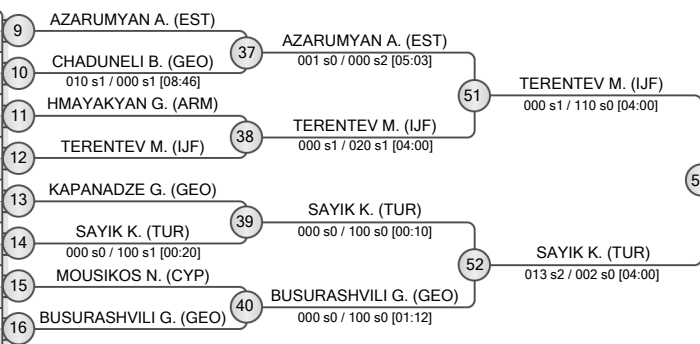

POOL C

	DARISPANASHVILI Luka	GEO
	NAGHDALYAN Aram	ARM
	BLATSHINSKY Ido	ISR
	TABA Titung	IND
	HADJIYIANNIS Nestoras	CYP
	ICHKITIDZE Tsotne	GEO
	MARTZIANO Eyal	ISR
	BERADZE Giorgi	GEO
	ARONGI Yehonatan	ISR

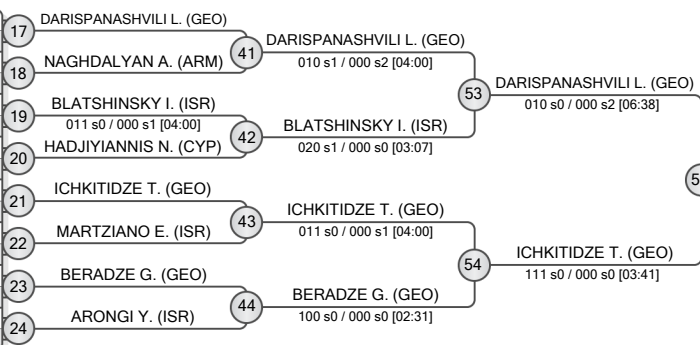

POOL D

	FRIDMAN Maor	ISR
	NAHAPETYAN Narek	ARM
	RAMONOV David	IJF
	KOTOLASHVILI Tamaz	GEO
	KARIMOV Dilshod	UZB
	GARAYEV Ilkin	AZE
	GIVISHVILI Nikoloz	GEO
	SHAASHOUA Chanoch Eliezer	ISR
	DIMITROV Samuil	BUL

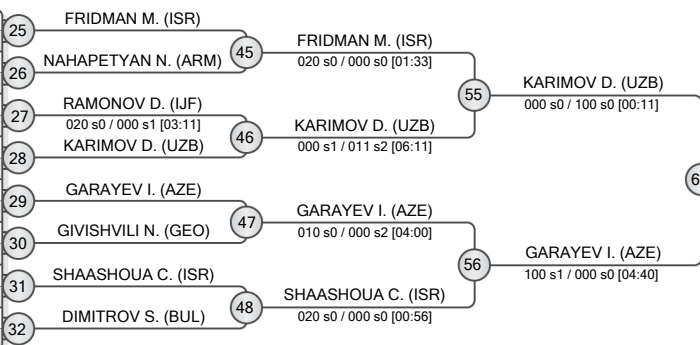

FINAL RESULTS		
1.	ICHKITIDZE Tsotne	GEO
2.	NOSIROV Mukhammadkarim	UZB
3.	ALASGAROV Zeyd	AZE
3.	TERENTEV Matvei	IJF
5.	GARAYEV Ilkin	AZE
5.	KARIMOV Dilshod	UZB
7.	SAYIK Kerem	TUR
7.	DARISPANASHVILI Luka	GEO

REPECHAGE

	ISMAILOV R. (IJF)	61
	GEGIA G. (GEO)	65
	HMAYAKYAN G. (ARM)	62
	AZARUMYAN A. (EST)	66
	MARTZIANO E. (ISR)	63
	BERADZE G. (GEO)	67
	GIVISHVILI N. (GEO)	64
	SHAASHOUA C. (ISR)	68

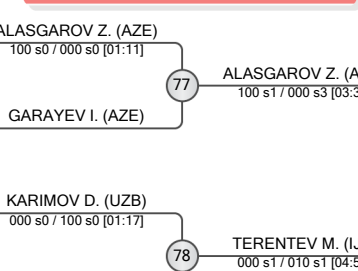
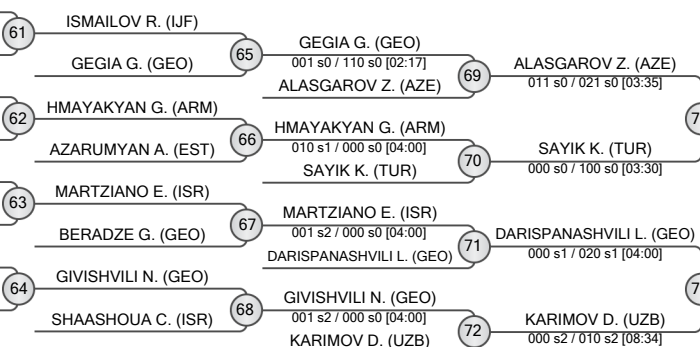



Tbilisi Millennium Team Cadet European Cup 2025

Georgia, Tbilisi, 12-13 Apr 2025

-66 kg

Men (39)

POOL A

1	KEKVIASHVILI Gigi	GEO
2	KHAMKHOEV Rakhim	IJF
3	QALANDAROV Muhammadyor	TJK
4	SHACHAM Itamar	ISR
5	MAMMADOV Kanan	AZE
6	GILAD Itay	ISR
7	GIGANI Bacho	GEO
8	THOKCHOM Pravendev Singh	IND
9	KOKOLAYEV Yarin	ISR

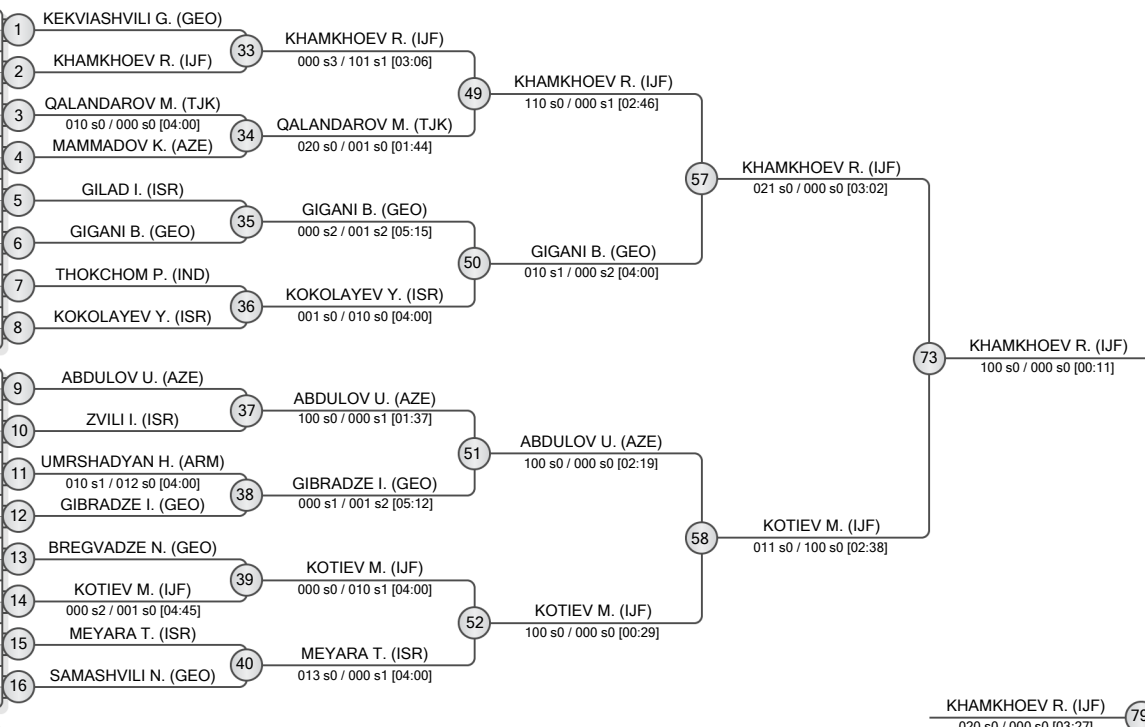

POOL B

9	ABDULOV Umid	AZE
10	ZVILI Ido	ISR
11	PINAR Omer Faruk	TUR
12	UMRSHADYAN Hakob	ARM
13	GIBRADZE Irakli	GEO
14	BREGVADZE Nika	GEO
15	NIKOLCHEV Ivan	BUL
16	KOTIEV Muslim	IJF
17	MEYARA Tom	ISR
18	SAMASHVILI Nikoloz	GEO

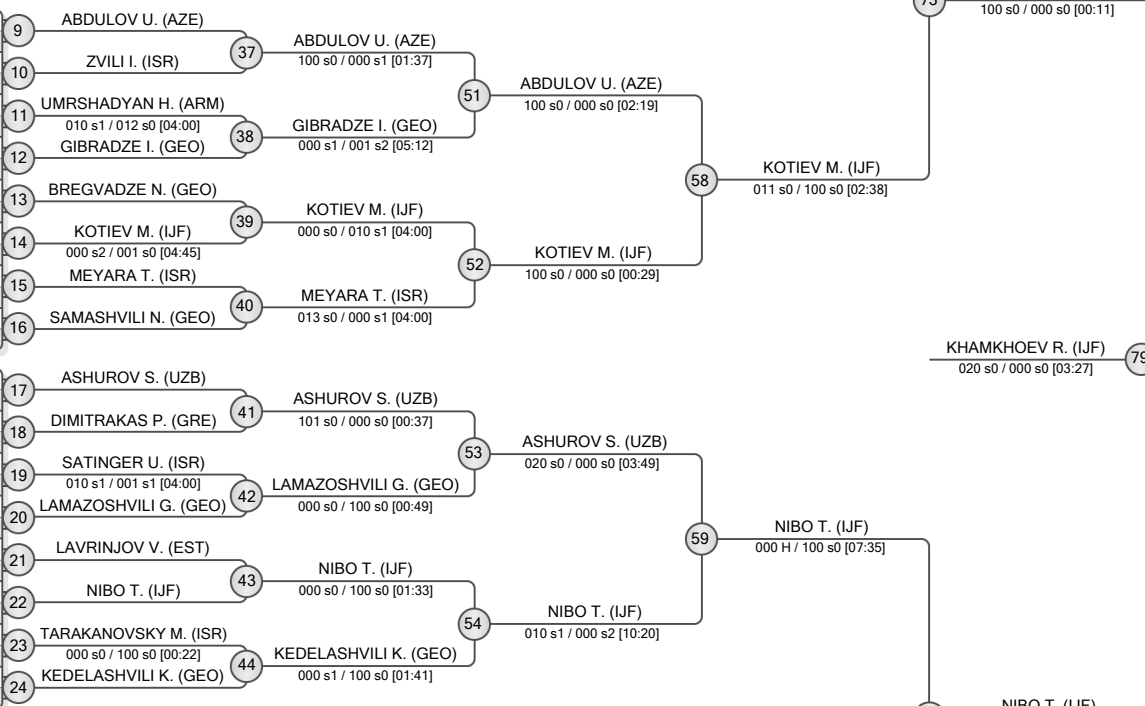

POOL C

17	ASHUROV Sanjarbek	UZB
18	DIMITRAKAS Panagiotis	GRE
19	SATINGER Uri Ezekiel	ISR
20	SHOHINZODA Shohaziz	TJK
21	LAMAZOSHVILI Giga	GEO
22	LAVRINJOV Volodomor	EST
23	NIBO Tamerlan	IJF
24	AVETISYAN Vahan	ARM
25	TARAKANOVSKY Michail	ISR
26	KEDELASHVILI Koba	GEO

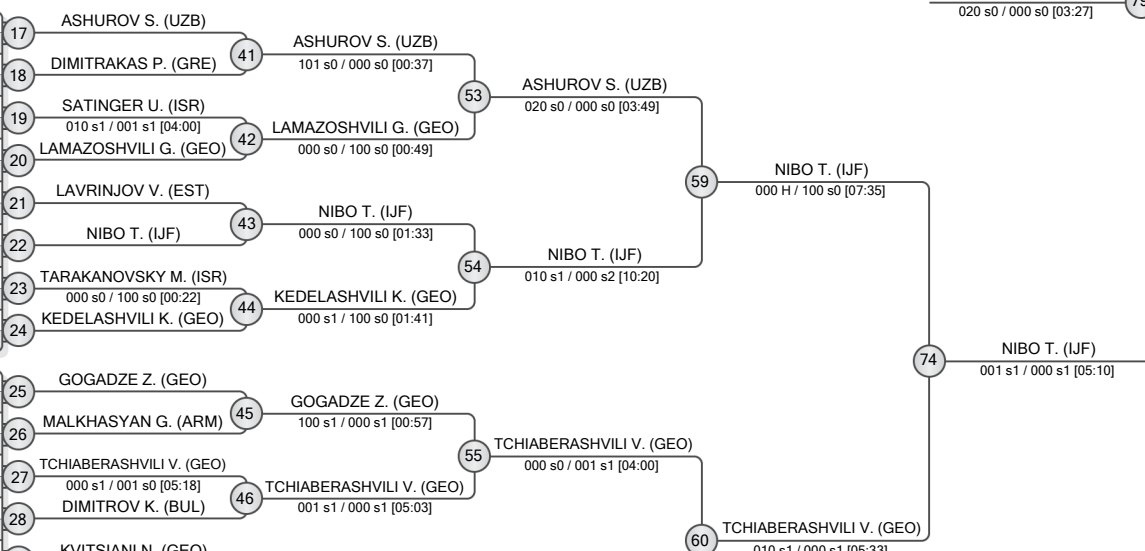

POOL D

25	GOGADZE Zurab	GEO
26	MALKHASYAN Garik	ARM
27	GORELASHVILI Lior	ISR
28	TCHIABERASHVILI Vakhtangi	GEO
29	DIMITROV Kristiyan	BUL
30	KVITSIANI Nika	GEO
31	BRODSKY Jonathan	ISR
32	POLAT Sivan Umut	TUR
33	NASRULLAYEV Najaf	AZE
34	FARBEROFF ISAZA Ariel	ISR

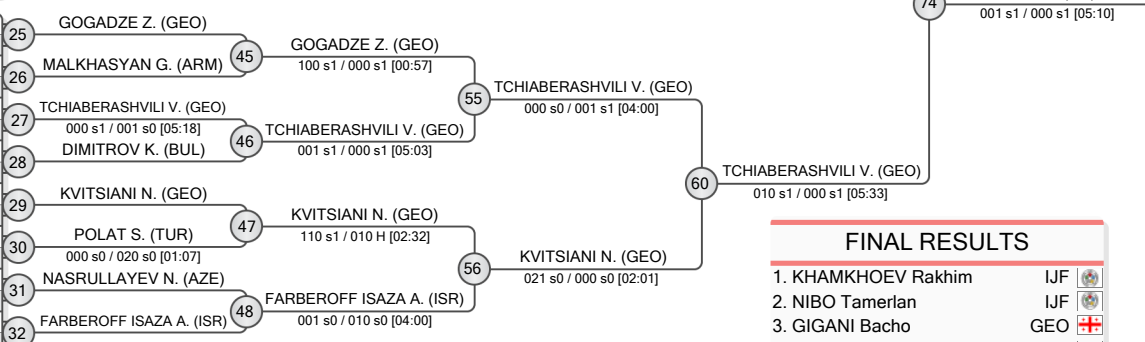

FINAL RESULTS		
1.	KHAMKHOEV Rakhim	IJF
2.	NIBO Tamerlan	IJF
3.	GIGANI Bacho	GEO
3.	GOGADZE Zurab	GEO
5.	TCHIABERASHVILI Vakhtangi	GEO
7.	ABDULOV Umid	AZE
7.	KEDELASHVILI Koba	GEO

REPECHAGE

61	KEKVIASHVILI G. (GEO)
62	NIKOLCHEV I. (BUL)
63	BREGVADZE N. (GEO)
64	LAVRINJOV V. (EST)
65	GORELASHVILI L. (ISR)
66	DIMITROV K. (BUL)

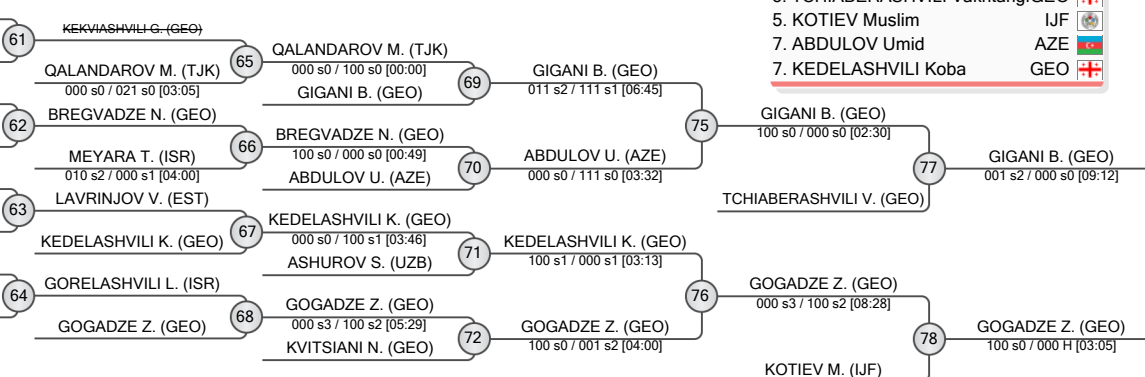



Tbilisi Millennium Team Cadet European Cup 2025

Georgia, Tbilisi, 12-13 Apr 2025

-73 kg

Men (31)

POOL A

	NEMATOV Roshid	TJK	1	NEMATOV R. (TJK)
	BICHOEV Atkhan	IJF	2	BICHOEV A. (IJF)
	KVITSIANI Nikoloz	GEO	3	KVITSIANI N. (GEO)
	MIHALEV Nikolaz	BUL	4	MIHALEV N. (BUL)
	ERTEM Huseyin	TUR	5	ERTEM H. (TUR)
	BEN SHITRIT Ehud	ISR	6	BEN SHITRIT E. (ISR)
	BEGASHVILI Davit	GEO	7	BEGASHVILI D. (GEO)

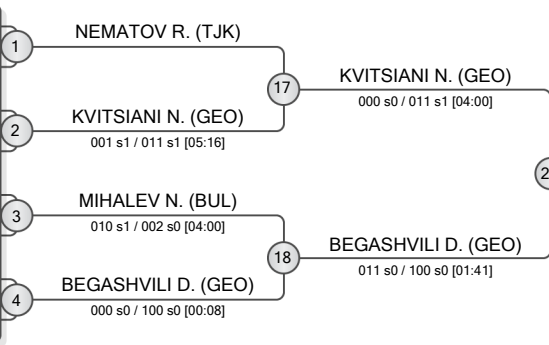

POOL B

	NANAVA Luka	GEO	5	NANAVA L. (GEO)
	ERZAMAN Kris	TUR	6	ERZAMAN K. (TUR)
	ZIV Shaked	ISR	7	ZIV S. (ISR)
	AKRAMOV Sharifjon	TJK	8	AKRAMOV S. (TJK)
	SARUKHANYAN Tigran	ARM	9	SARUKHANYAN T. (ARM)
	NAZAR Yusuf	AZE	10	NAZAR Y. (AZE)
	KUTATELADZE Luka	GEO	11	KUTATELADZE L. (GEO)
	PIMA Ilay	ISR	12	PIMA I. (ISR)

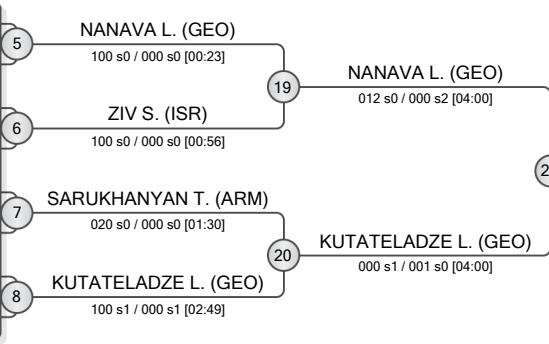

POOL C

	KRIVOLAPOV Egor	KGZ	9	KRIVOLAPOV E. (KGZ)
	KHECHOYAN Arman	ARM	10	KHECHOYAN A. (ARM)
	BEN LAICHE Edo	ISR	11	BEN LAICHE E. (ISR)
	IMERLISHVILI Luka	GEO	12	IMERLISHVILI L. (GEO)
	SAMSIANI Ieso	GEO	13	SAMSIANI I. (GEO)
	BASHKAEV Al-Malik	IJF	14	BASHKAEV A. (IJF)
	DIMITROV Plamen	BUL	15	DIMITROV P. (BUL)
	HARSHIT Harshit	IND	16	HARSHIT H. (IND)

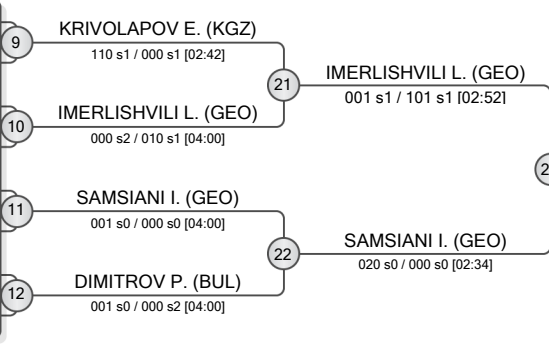

POOL D

	MACHURIDZE Vladimer	GEO	13	MACHURIDZE V. (GEO)
	SHAROPOV Bobodzhon	TJK	14	SHAROPOV B. (TJK)
	PERTSEV Emile	ISR	15	PERTSEV E. (ISR)
	ARSLAN Ibrahim Ethem	TUR	16	ARSLAN I. (TUR)
	BRUZHANITSKY Tal	ISR	17	BRUZHANITSKY T. (ISR)
	RAVSHANOV Sadulla	UZB	18	RAVSHANOV S. (UZB)
	DZAMULASHVILI Jumber	GEO	19	DZAMULASHVILI J. (GEO)
	GALSTYAN Gor	ARM	20	GALSTYAN G. (ARM)

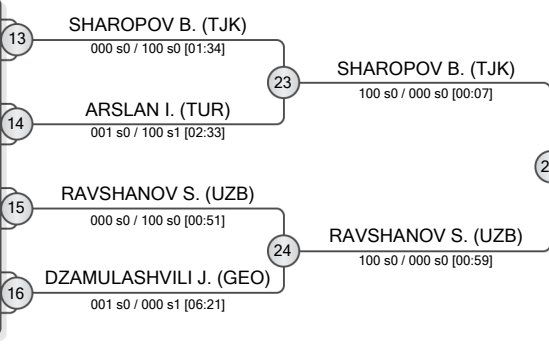

REPECHAGE

	BICHOEV A. (IJF)	29	BICHOEV A. (IJF)
	NEMATOV R. (TJK)	30	NEMATOV R. (TJK)
	PIMA I. (ISR)	31	PIMA I. (ISR)
	SARUKHANYAN T. (ARM)	32	SARUKHANYAN T. (ARM)
	BASHKAEV A. (IJF)	33	BASHKAEV A. (IJF)
	DIMITROV P. (BUL)	34	DIMITROV P. (BUL)
	BRUZHANITSKY T. (ISR)	35	BRUZHANITSKY T. (ISR)
	DZAMULASHVILI J. (GEO)	36	DZAMULASHVILI J. (GEO)

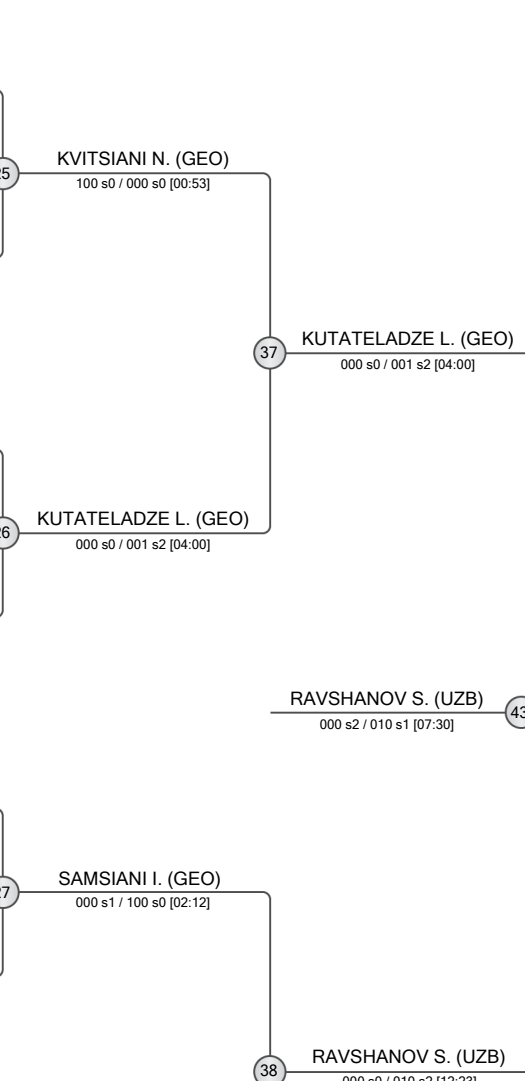
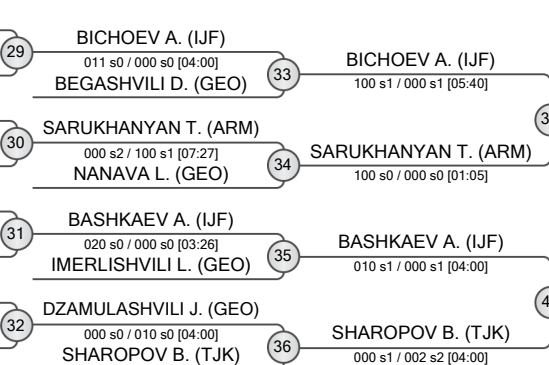

FINAL RESULTS

1.	RAVSHANOV Sadulla	UZB	
2.	KUTATELADZE Luka	GEO	
3.	BICHOEV Atkhan	IJF	
4.	BASHKAEV Al-Malik	IJF	
5.	SAMSIANI Ieso	GEO	
6.	KVITSIANI Nikoloz	GEO	
7.	SARUKHANYAN Tigran	ARM	
8.	SHAROPOV Bobodzhon	TJK	





Tbilisi Millennium Team Cadet European Cup 2025

Georgia, Tbilisi, 12-13 Apr 2025

-81 kg

Men (25)

POOL A

	SIMONOV Aleksandr	KGZ	1
	TSILIKISHILI Luka	GEO	2
	ABBASALI Mahammad	AZE	3
	KILADZE Giorgi	GEO	4
	IAKOVOU Michalis	CYP	5
	ANTONOV Matvei	IJF	6
	BHAVYA Bhavya	IND	7

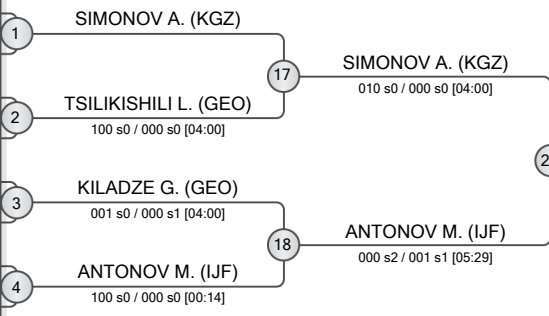

POOL B

	BUZIASHVILI Luka	GEO	5
	LARIOS Anastasios	GRE	6
	FILYAN Artyom	ARM	7
	LATSABIDZE Valeri	GEO	8
	ALIEV Timur	IJF	9
	BAKHODIROV Inomjon	UZB	10

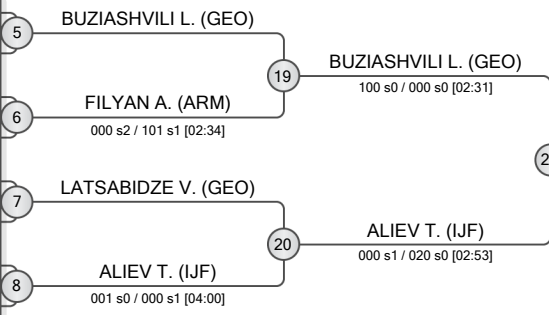

POOL C

	SAMSIANI Saba	GEO	9
	NAZLIS Dimitrios	GRE	10
	KHIDIROV Ramazan	IJF	11
	SHNIDER Omer	ISR	12
	CELIK Emir Musap	TUR	13
	BAKHTADZE Saba	GEO	14

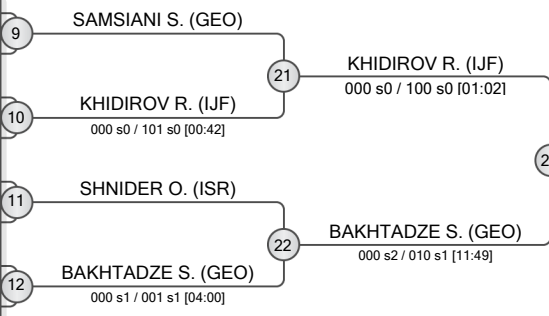

POOL D

	AKHUNDOV Omar	AZE	13
	MACHAVARIANI Nikita	GEO	14
	AKRAMOV Akram	TJK	15
	MUSELIANI Shota	GEO	16
	MUSTAFAEV Mark	KGZ	17
	PUPKOV Aleksandr	IJF	18

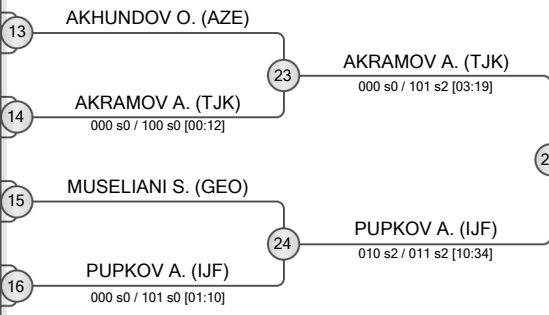

REPECHAGE

29	TSILIKISHILI L. (GEO)	33	ANTONOV M. (IJF)
30	LATSABIDZE V. (GEO)	34	BAKHODIROV I. (UZB)
31	SAMSIANI S. (GEO)	35	BAKHTADZE S. (GEO)
32	MUSELIANI S. (GEO)	36	AKRAMOV A. (TJK)

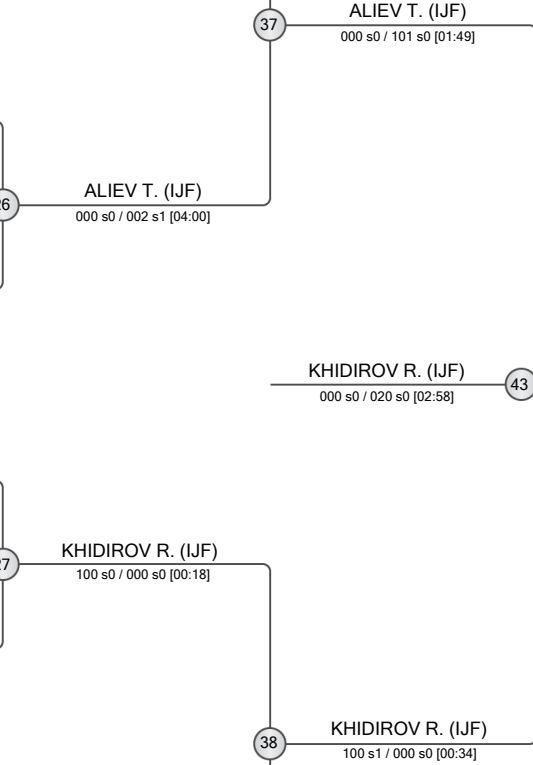
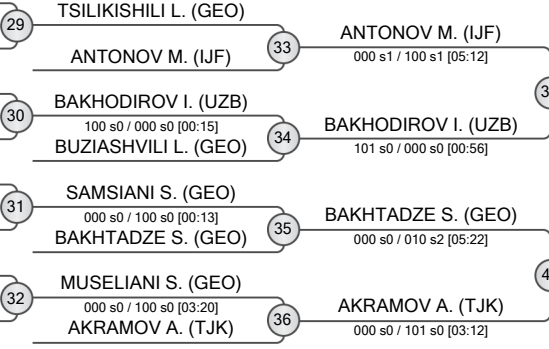

FINAL RESULTS

1.	KHIDIROV Ramazan	IJF	
2.	ALIEV Timur	IJF	
3.	BAKHODIROV Inomjon	UZB	
4.	SIMONOV Aleksandr	KGZ	
5.	PUPKOV Aleksandr	IJF	
6.	AKRAMOV Akram	TJK	
7.	ANTONOV Matvei	IJF	
8.	BAKHTADZE Saba	GEO	





Tbilisi Millennium Team Cadet European Cup 2025

Georgia, Tbilisi, 12-13 Apr 2025

-90 kg

Men (20)

POOL A

	AHROROV Musurmonkul	UZB	1	AHROROV M. (UZB)
	ZEDELASHVILI Giorgi	GEO	2	ZEDELASHVILI G. (GEO)
	ZAKARYAN Sergey	ARM		001 s0 / 000 s2 [04:00]
	GAL Ofri	ISR	3	GAL O. (ISR)
	KATAMADZE Giorgi	GEO	4	KATAMADZE G. (GEO)

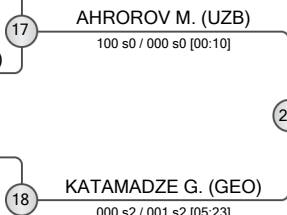

POOL B

	GADRANI Nikoloz	GEO	5	GADRANI N. (GEO)
	KARABASLI Doruk	TUR	6	SULEIMANOV A. (IJF)
	SULEIMANOV Abdula	IJF	6	000 s0 / 100 s0 [00:14]
	KOGUASHVILI Giorgi	GEO	7	KOGUASHVILI G. (GEO)
	BERUASHVILI Elguja	GEO	8	BERUASHVILI E. (GEO)

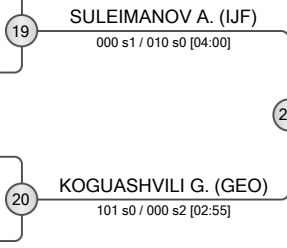

POOL C

	ABGAIDZE Luka	GEO	9	ABGAIDZE L. (GEO)
	AKOPIAN Arshaluis	IJF	10	AKOPIAN A. (IJF)
	SHIRINOV Emin	AZE	11	SHIRINOV E. (AZE)
	MOGILNI Kirill	ISR	12	MAKISHVILI U. (GEO)
	MAKISHVILI Ushangi	GEO	12	000 s0 / 101 s0 [01:47]

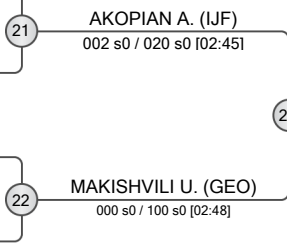

POOL D

	PRUIDZE Saba	GEO	13	PRUIDZE S. (GEO)
	KUMAR Ram	IND	14	MALAKHOV I. (IJF)
	MALAKHOV Igor	IJF	14	000 s1 / 110 s1 [02:13]
	KHAZRIYEV Amir	AZE	15	KHAZRIYEV A. (AZE)
	KRISTESIASHVILI Pridon	GEO	16	KRISTESIASHVILI P. (GEO)

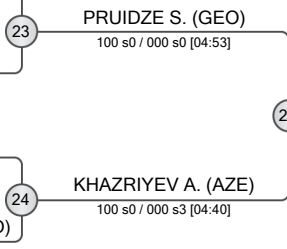

REPECHAGE

29	ZEDELASHVILI G. (GEO)	33	ZEDELASHVILI G. (GEO)
	KARABASLI D. (TUR)		KATAMADZE G. (GEO)
	GADRANI N. (GEO)	30	GADRANI N. (GEO)
			000 s0 / 100 s0 [00:26]
			KOGUASHVILI G. (GEO)
		34	KOGUASHVILI G. (GEO)
			001 s0 / 100 s1 [02:32]
			ABGAIDZE L. (GEO)
		31	ABGAIDZE L. (GEO)
			MAKISHVILI U. (GEO)
			100 s0 / 000 s0 [01:19]
			MALAKHOV I. (IJF)
		32	MALAKHOV I. (IJF)
			KHAZRIYEV A. (AZE)
			100 s1 / 000 s0 [02:09]

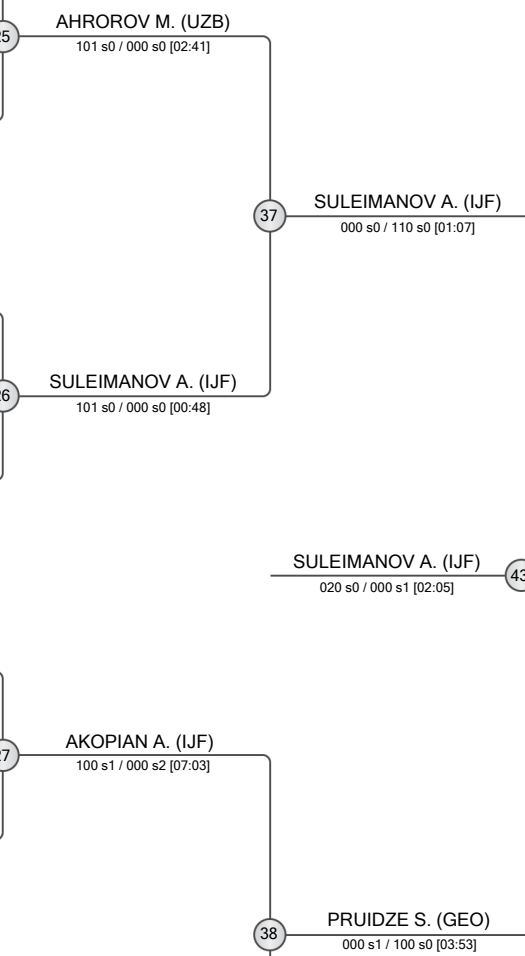

FINAL RESULTS

- SULEIMANOV Abdula (IJF)
- PRUIDZE Saba (GEO)
- KOGUASHVILI Giorgi (GEO)
- AHROROV Musurmonkul (UZB)
- ABGAIDZE Luka (GEO)
- AKOPIAN Arshaluis (IJF)
- ZEDELASHVILI Giorgi (GEO)
- MALAKHOV Igor (IJF)





Tbilisi Millennium Team Cadet European Cup 2025

Georgia, Tbilisi, 12-13 Apr 2025

+ 90 kg

Men (17)

POOL A

	BANAEIAN TOLKI Mohammadpouria	IRI	1	BANAEIAN TOLKI M. (IRI)
	JAPARIDZE Otari	GEO	2	JAPARIDZE O. (GEO)
	FARZALIYEV Elshan	AZE	3	FARZALIYEV E. (AZE)
	KONDI Alperen	TUR	4	KONDI A. (TUR)

POOL B

	DAVRASHELIDZE Hamlet	GEO	5	DAVRASHELIDZE H. (GEO)
	KULIGIN Denis	IJF	6	KULIGIN D. (IJF)
	MASIMOV Javidan	AZE	7	MASIMOV J. (AZE)
	KLDIASHVILI Bidzina	GEO	8	KLDIASHVILI B. (GEO)
	KHURSANDOV Kamol	UZB	8	020 s1 / 000 s2 [03:53]

POOL C

	ABALAKI Ioane	GEO	9	ABALAKI I. (GEO)
	KAMAL Arda	TUR	10	KAMAL A. (TUR)
	DURDIEV Alibek	UZB	11	DURDIEV A. (UZB)
	GAGNIDZE Luka	GEO	12	GAGNIDZE L. (GEO)

POOL D

	ZAKUTASHVILI Ilia	GEO	13	ZAKUTASHVILI I. (GEO)
	BRAR Babnoor Singh	IND	14	BRAR B. (IND)
	KASHIBADZE Giorgi	GEO	15	KASHIBADZE G. (GEO)
	KHARLOV Pavel	IJF	16	KHARLOV P. (IJF)

REPECHAGE

	FARZALIYEV E. (AZE)	29	FARZALIYEV E. (AZE)	33	BANAEIAN TOLKI M. (IRI)
	DAVRASHELIDZE H. (GEO)	30	DAVRASHELIDZE H. (GEO)	34	KLDIASHVILI B. (GEO)
	KAMAL A. (TUR)	31	KAMAL A. (TUR)	35	GAGNIDZE L. (GEO)
	BRAR B. (IND)	32	BRAR B. (IND)	36	KASHIBADZE G. (GEO)

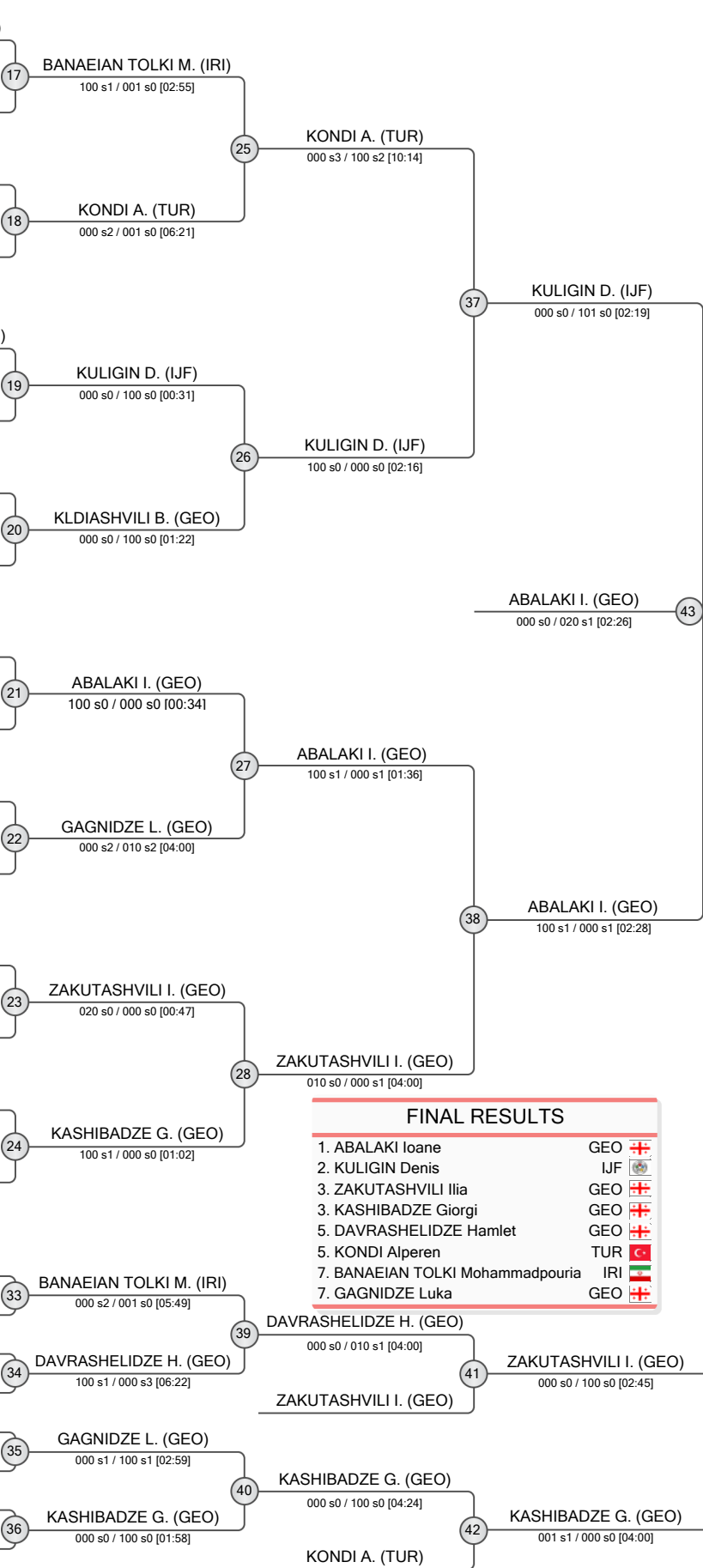

FINAL RESULTS

1.	ABALAKI Ioane	GEO	
2.	KULIGIN Denis	IJF	
3.	ZAKUTASHVILI Ilia	GEO	
3.	KASHIBADZE Giorgi	GEO	
5.	DAVRASHELIDZE Hamlet	GEO	
5.	KONDI Alperen	TUR	
7.	BANAEIAN TOLKI Mohammadpouria	IRI	
7.	GAGNIDZE Luka	GEO	





Tbilisi Millennium Team Cadet European Cup 2025

Georgia, Tbilisi, 12-13 Apr 2025

-40 kg

Women (6)

POOL A

HUSEYNOVA Madina AZE

HUSEYNOVA M. (AZE)

POOL B

SAIFUTDINOVA Emilia IJF
 KOLUCHEVA Alina UZB

SAIFUTDINOVA E. (IJF)

POOL C

RATHOR Taniya IND

RATHOR T. (IND)

POOL D

DZEBOEVA Amina IJF
 SHEVCHUK Anastasiia IJF

SHEVCHUK A. (IJF)

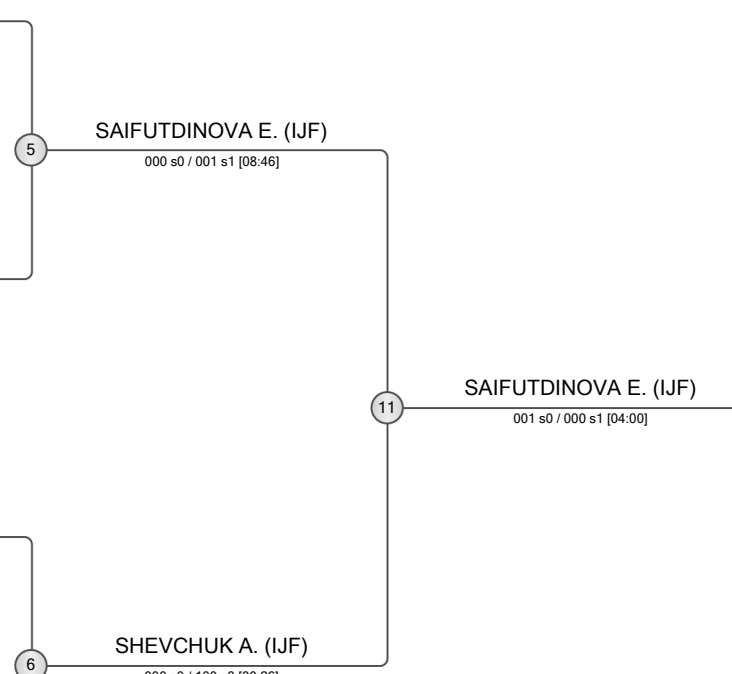

FINAL RESULTS		
1.	SAIFUTDINOVA Emilia	IJF
2.	SHEVCHUK Anastasiia	IJF
3.	KOLUCHEVA Alina	UZB
3.	DZEBOEVA Amina	IJF

REPECHAGE

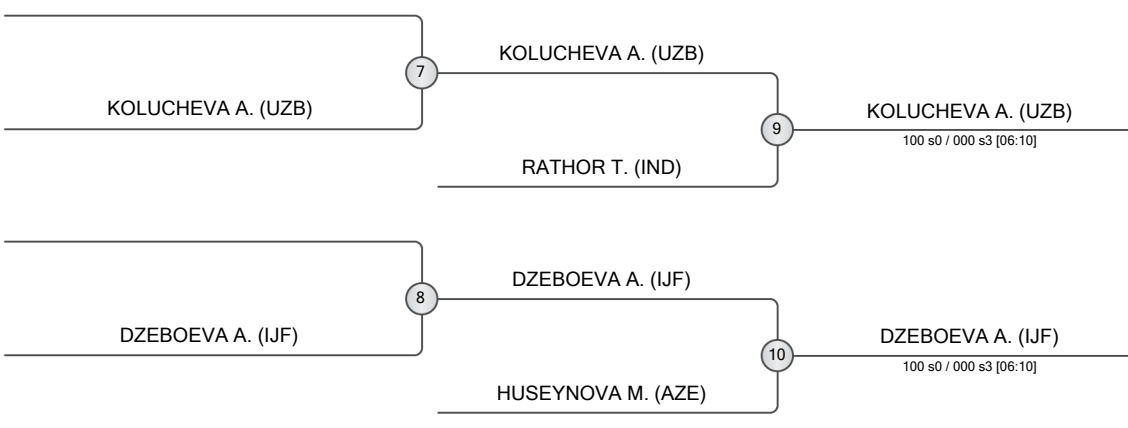



Tbilisi Millennium Team Cadet European Cup 2025

Georgia, Tbilisi, 12-13 Apr 2025

-44 kg

Women (15)

POOL A

	MISHENKINA Nadezhda	IJF
	ABDULLAYEVA Fatima	AZE
	PAVLIDI Alexandra	GRE

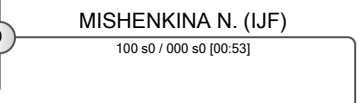
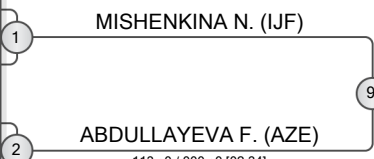

POOL B

	HUSEYNOVA Gulshan	AZE
	ULIUMDZHIEVA Valeriia	IJF
	AZARUMYAN Anna	EST
	MEGRELISHVILI Mariami	GEO

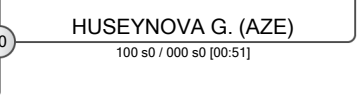
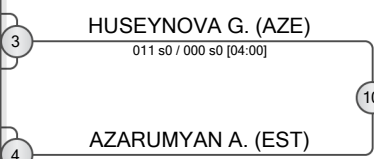

POOL C

	GADANOVA Alina	IJF
	GHELANI Rahi Rajeshkumar	IND
	TSOTSKOLAURI Khatia	GEO
	ORISHCHENKO Anna-Mariia	IJF

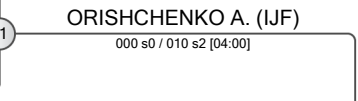
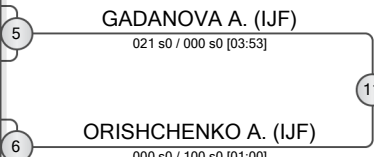

POOL D

	ABDULLAYEVA Khadija	AZE
	KHASANOVA Dinora	UZB
	SAPARASHVILI Nino	GEO
	AKHTIAMOVA Regina	IJF

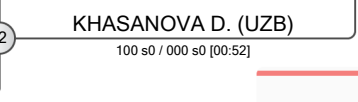
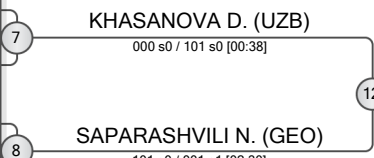

FINAL RESULTS		
1.	MISHENKINA Nadezhda	IJF
2.	KHASANOVA Dinora	UZB
3.	ORISHCHENKO Anna-Mariia	IJF
4.	ABDULLAYEVA Khadija	AZE
5.	ULIUMDZHIEVA Valeriia	IJF
6.	HUSEYNOVA Gulshan	AZE
7.	ABDULLAYEVA Fatima	AZE
8.	GADANOVA Alina	IJF

REPECHAGE

13 ABDULLAYEVA F. (AZE)
14 ULIUMDZHIEVA V. (IJF)
15 GADANOVA A. (IJF)
16 SAPARASHVILI N. (GEO)

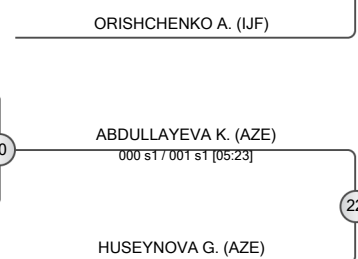
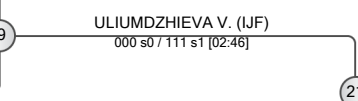
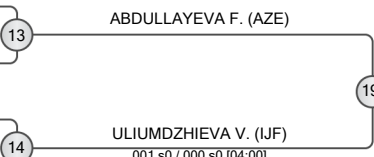



Tbilisi Millennium Team Cadet European Cup 2025

Georgia, Tbilisi, 12-13 Apr 2025

-48 kg

Women (22)

POOL A

	ZAKHAROVA Sofia	IJF	1
	KULAK Elif Azra	TUR	2
	MAMISHOVA Nigar	AZE	3
	HUIDROM Oliviya Devi	IND	4
	AHMADOVA Nargiz	AZE	5
	TSURTSUMIA Mariam	GEO	6

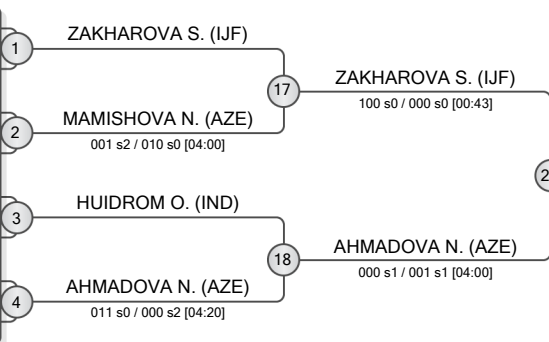

POOL B

	SHLAYFER Liah	ISR	5
	MUSAYEVA Gulgaz	AZE	6
	PARULAVA Mariam	GEO	7
	KUCUK Beyza	TUR	8
	AIMUKHAMEDOVA Sabina	IJF	9

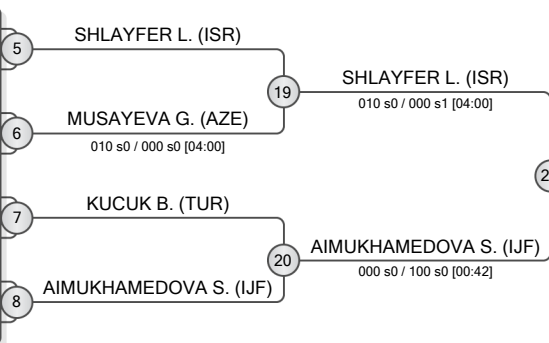

POOL C

	DUSTMAMTOVA Nargiza	UZB	9
	KHURANOVA Karina	IJF	10
	DALAKCI Esmahan	TUR	11
	ALAKBAROVA Leyla	AZE	12
	IASHVILI Natali	GEO	13

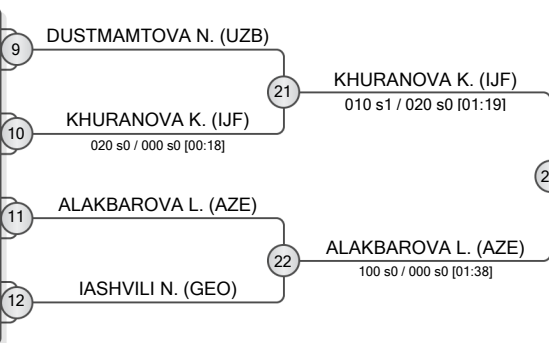

POOL D

	AGHAMIRZAZADE Narmin	AZE	13
	TSAKULOVA Zarina	IJF	14
	STOLAR Maia	ISR	15
	EYVAZLI Konul	AZE	16
	BOGUS Alina	IJF	17
	SHIVANGI Shivangi	IND	18

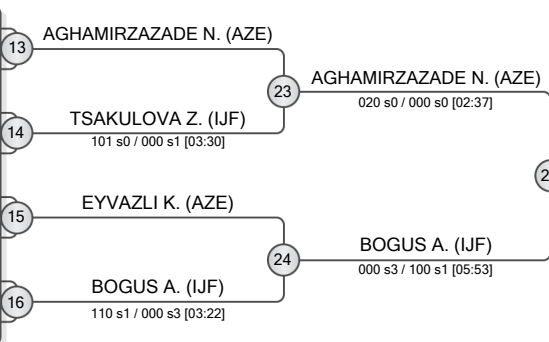

REPECHAGE

29 MAMISHOVA N. (AZE)	30 KUCUK B. (TUR)	31 IASHVILI N. (GEO)	32 TSAKULOVA Z. (IJF)
33 AHMADOVA N. (AZE)	34 SHLAYFER L. (ISR)	35 KHURANOVA K. (IJF)	36 BOGUS A. (IJF)

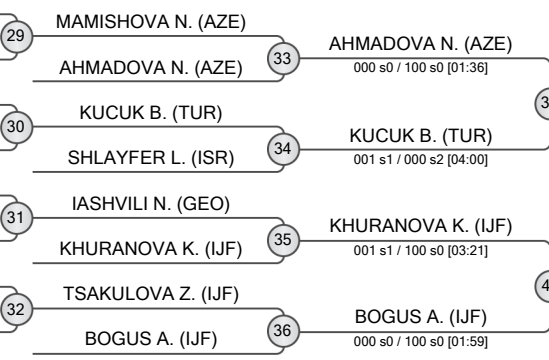

FINAL RESULTS	
1. ZAKHAROVA Sofia	IJF
2. AGHAMIRZAZADE Narmin	AZE
3. ALAKBAROVA Leyla	AZE
3. BOGUS Alina	IJF
5. AHMADOVA Nargiz	AZE
7. AIMUKHAMEDOVA Sabina	IJF
7. KUCUK Beyza	TUR
7. KHURANOVA Karina	IJF





Tbilisi Millennium Team Cadet European Cup 2025

Georgia, Tbilisi, 12-13 Apr 2025

-52 kg

Women (19)

POOL A

	KOZLOVA Valeriia	IJF	1	KOZLOVA V. (IJF)
	IVANIDZE Ketevan	GEO	2	IVANIDZE K. (GEO)
	MURSALIYEVA Maleyka	AZE	3	MURSALIYEVA M. (AZE)
	ALIMOVA Zuhra	UZB	4	ALIMOVA Z. (UZB)
	BENDELIANI Mariam	GEO	4	ALIMOVA Z. (UZB)

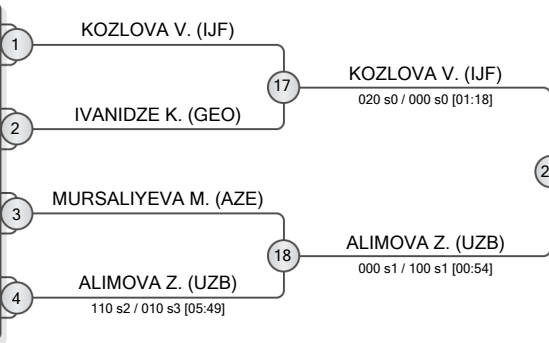

POOL B

	QURBONZODA Madina	TJK	5	QURBONZODA M. (TJK)
	ARIK Ecem Zisan	TUR	6	KHABAZI N. (GEO)
	KHABAZI Nino	GEO	6	KHABAZI N. (GEO)
	GULIASHVILI Mariam	GEO	7	GULIASHVILI M. (GEO)
	ZILBERMAN Yehely	ISR	8	ZILBERMAN Y. (ISR)

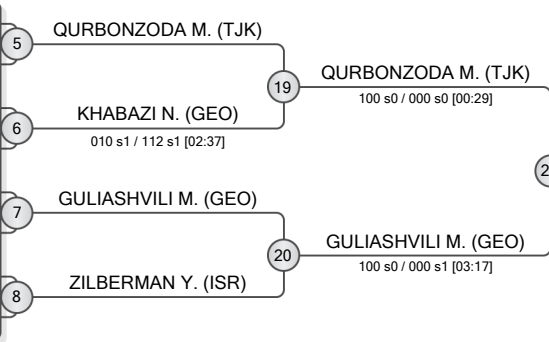

POOL C

	MAMMADOVA Aysun	AZE	9	MAMMADOVA A. (AZE)
	TOTRASHVILI Mariam	GEO	10	TOTRASHVILI M. (GEO)
	YESILTAS Semanur	TUR	11	YESILTAS S. (TUR)
	ESHEL Carmel	ISR	12	ESHEL C. (ISR)

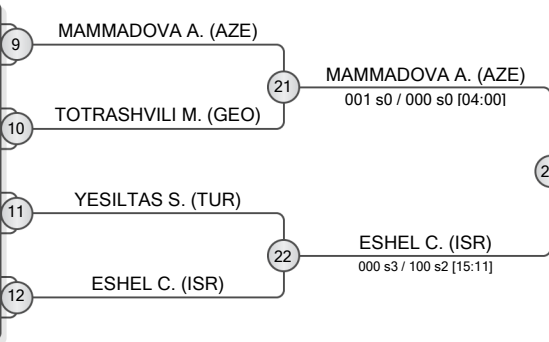

POOL D

	KHARAISHVILI Nino	GEO	13	KHARAISHVILI N. (GEO)
	FURMAN Polina	IJF	14	FURMAN P. (IJF)
	KORETI Ranjita	IND	14	FURMAN P. (IJF)
	URBEKHASHVILI Sopiko	GEO	15	URBEKHASHVILI S. (GEO)
	BABAYEVA Tovsiyya	AZE	16	BABAYEVA T. (AZE)

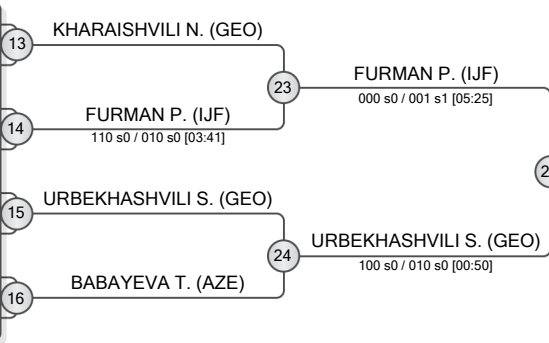

REPECHAGE

29	IVANIDZE K. (GEO)	33	ALIMOVA Z. (UZB)
30	KHABAZI N. (GEO)	34	GULIASHVILI M. (GEO)
31	TOTRASHVILI M. (GEO)	35	ESHEL C. (ISR)
32	KHARAISHVILI N. (GEO)	36	KORETI R. (IND)

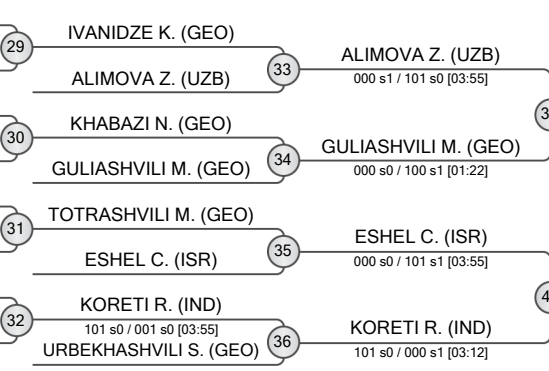

FINAL RESULTS		
1.	KOZLOVA Valeriia	IJF
2.	FURMAN Polina	IJF
3.	GULIASHVILI Mariam	GEO
5.	QURBONZODA Madina	TJK
5.	MAMMADOVA Aysun	AZE
7.	KORETI Ranjita	IND
7.	ALIMOVA Zuhra	UZB
7.	ESHEL Carmel	ISR





Tbilisi Millennium Team Cadet European Cup 2025

Georgia, Tbilisi, 12-13 Apr 2025

-57 kg

Women (28)

POOL A

	TATRISHVILI Sopio	GEO
	VALIYEVA Nazakat	AZE
	KALOEVA Zita	IJF
	KYIALBEKOVA Aaisha	KGZ
	BECHVAIA Elisabed	GEO
	GULUASHVILI Ani	GEO
	AYKUTLU Yagmur	TUR

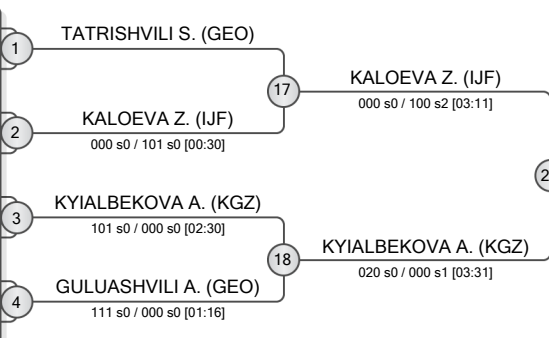

POOL B

	GULBANI Tinatin	GEO
	CHANAMBAM Jeeny	IND
	SUPRUN Ameliia	IJF
	AKHMEDOVA Maftuna	UZB
	KHORBALADZE Mariam	GEO
	KHARAZISHVILI Ketevan	GEO
	TOPALOGLU Berra	TUR

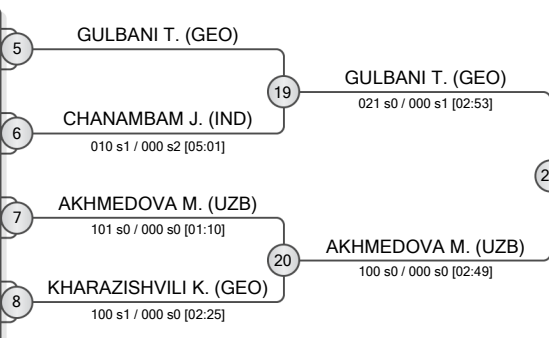

POOL C

	GAMIASHVILI Tamar	GEO
	MAMMADTAGHIYEVA Gulnaz	AZE
	LAKSHAKAR Lagan	IND
	YILMAZ Lara	TUR
	SVIANIDZE Maka	GEO
	OKRUASHVILI Mariami	GEO
	BELOVA Anastasiia	IJF

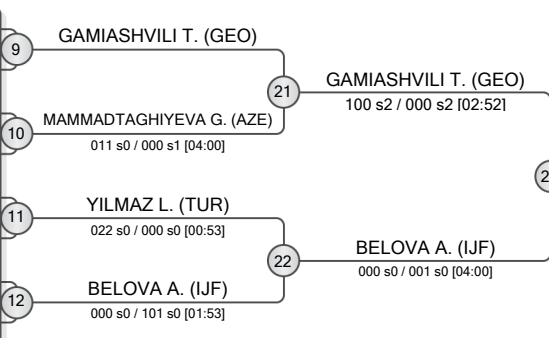

POOL D

	GOGALADZE Diana	GEO
	SIMONIA Lizi	GEO
	KIRILLOVA Stefaniia	IJF
	TOPCU Ezgi	TUR
	ASARIOTI Eleni	GRE
	YUSIFLI Samaya	AZE
	KITIASHVILI Mariam	GEO

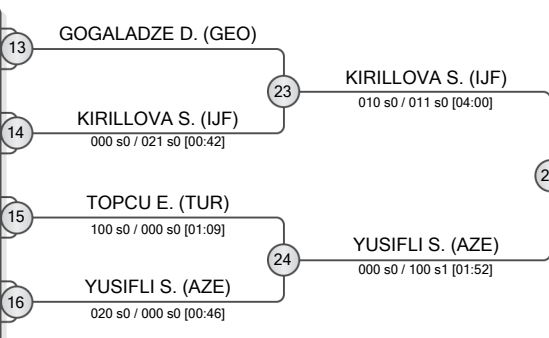

REPECHAGE

29	GULUASHVILI A. (GEO)	000 s1 / 100 s0 [01:20]
30	CHANAMBAM J. (IND)	
31	YILMAZ L. (TUR)	000 s0 / 100 s0 [00:30]
32	GOGALADZE D. (GEO)	100 s1 / 000 s1 [02:04]
33	KALOEVA Z. (IJF)	000 s0 / 020 s0 [01:18]
34	AKHMEDOVA M. (UZB)	000 s0 / 100 s0 [00:28]
35	GAMIASHVILI T. (GEO)	101 s0 / 000 s0 [01:17]
36	YUSIFLI S. (AZE)	001 s0 / 101 s1 [03:26]

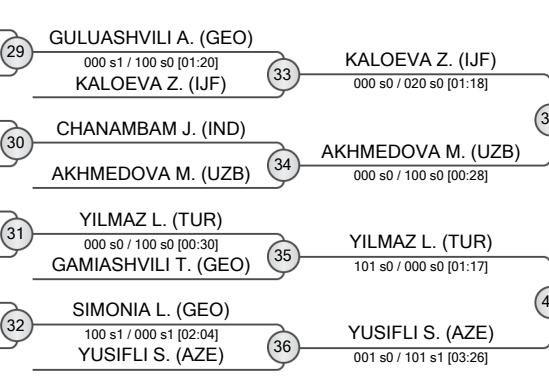

FINAL RESULTS

- GULBANI Tinatin (GEO)
- KIRILLOVA Stefaniia (IJF)
- AKHMEDOVA Maftuna (UZB)
- YILMAZ Lara (TUR)
- BELOVA Anastasiia (IJF)
- KYIALBEKOVA Aaisha (KGZ)
- KALOEVA Zita (IJF)
- YUSIFLI Samaya (AZE)





Tbilisi Millennium Team Cadet European Cup 2025

Georgia, Tbilisi, 12-13 Apr 2025

-63 kg

Women (21)

POOL A

	GULBIANI Nana	GEO	1	GULBIANI N. (GEO)
	HUSEYNZADA Zahra	AZE	2	HUSEYNZADA Z. (AZE)
	OURANITSA Chrysoula-Stavroula	GRE	3	OURANITSA C. (GRE)
	LOLADZE Mariami	GEO	4	AKPINAR N. (TUR)
	AKPINAR Nisa	TUR		000 s0 / 100 s0 [02:06]

POOL B

	BILEN Sevim Margaret	TUR	5	BILEN S. (TUR)
	MAZANASHVILI Dali	GEO	6	MARGIEVA M. (IJF)
	MARGIEVA Marianna	IJF		000 s0 / 100 s0 [00:07]
	PKHAKADZE Barbara	GEO	7	PKHAKADZE B. (GEO)
	YILMAZ Duru	TUR	8	YILMAZ D. (TUR)
	NAKHUTSRISHVILI Lika	GEO		101 s0 / 000 s0 [01:14]

POOL C

	UMAROVA Zukhrajon	UZB	9	UMAROVA Z. (UZB)
	DAVADZE Liza	GEO	10	DAVADZE L. (GEO)
	ALIEVA Aishat	IJF	11	ALIEVA A. (IJF)
	TASCIOGLU Ceylin Yagmur	TUR	12	MARKHVAIDZE L. (GEO)
	MARKHVAIDZE Lizi	GEO		000 s0 / 100 s0 [00:45]

POOL D

	KUTIBASHVILI Salome	GEO	13	KUTIBASHVILI S. (GEO)
	KHUYENTHEM Monika Devi	IND	14	KHUYENTHEM M. (IND)
	ORS Tugce Ceren	TUR	15	ALIYEVA A. (AZE)
	ALIYEVA Ayan	AZE		110 s0 / 000 s1 [02:38]
	BALAKHASHVILI Lika	GEO	16	BALAKHASHVILI L. (GEO)

REPECHAGE

	HUSEYNZADA Z. (AZE)	29	HUSEYNZADA Z. (AZE)	33	OURANITSA C. (GRE)
	MAZANASHVILI D. (GEO)		OURANITSA C. (GRE)		000 s0 / 100 s0 [02:13]
	BILEN S. (TUR)	30	BILEN S. (TUR)	34	BILEN S. (TUR)
	BILEN S. (TUR)		YILMAZ D. (TUR)		002 s0 / 001 s2 [04:00]
	MARKHVAIDZE L. (GEO)	31	MARKHVAIDZE L. (GEO)	35	UMAROVA Z. (UZB)
	ORS T. (TUR)		UMAROVA Z. (UZB)		000 s0 / 020 s0 [01:57]
	KUTIBASHVILI S. (GEO)	32	ORS T. (TUR)	36	ALIYEVA A. (AZE)
			ALIYEVA A. (AZE)		110 s0 / 000 s1 [04:00]

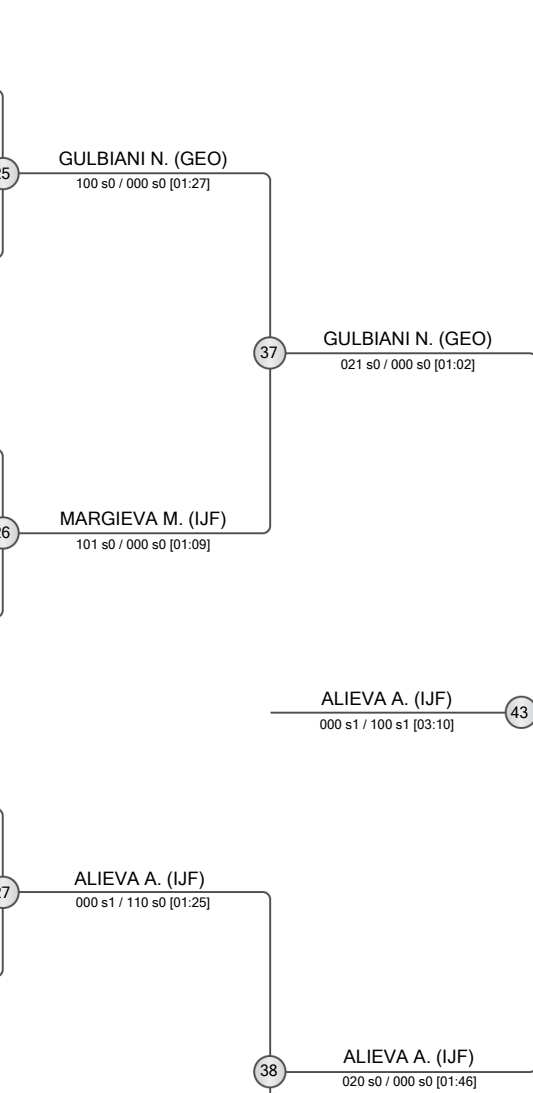

FINAL RESULTS

- ALIEVA Aishat (IJF)
- GULBIANI Nana (GEO)
- BILEN Sevim Margaret (TUR)
- UMAROVA Zukhrajon (UZB)
- KHUYENTHEM Monika Devi (IND)
- MARGIEVA Marianna (IJF)
- OURANITSA Chrysoula-Stavroula (GRE)
- ALIYEVA Ayan (AZE)





Tbilisi Millennium Team Cadet European Cup 2025

Georgia, Tbilisi, 12-13 Apr 2025

-70 kg

Women (12)

POOL A

	ROBAKIDZE Ketii	GEO
	COSKUN Tuba	TUR
	DZHIGAROS Darina	IJF

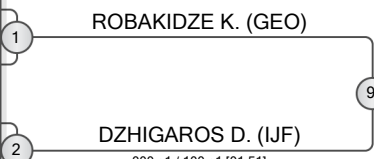

POOL B

	MICHAIL Maria	CYP
	MAMMADLI Masuma	AZE
	GHVALADZE Maia	GEO

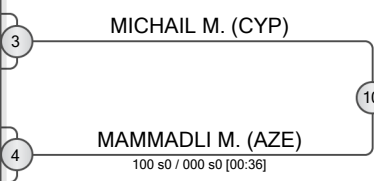

POOL C

	UZAKBAEVA Intizor	UZB
	AHMADOVA Rena	AZE
	OSKOLKOVI Tamara	GEO

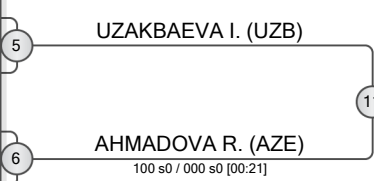

POOL D

	DZAGANIA Nini	GEO
	ELBAZ Shani	ISR
	CHEKMAREVA Alina	IJF

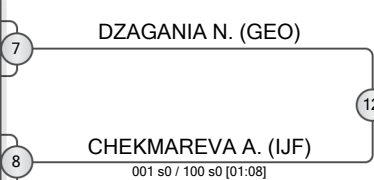

REPECHAGE

DZHIGAROS D. (IJF)	13
GHVALADZE M. (GEO)	14
MICHAIL M. (CYP)	14
AHMADOVA R. (AZE)	15
ELBAZ S. (ISR)	15
DZAGANIA N. (GEO)	16
DZAGANIA N. (GEO)	16

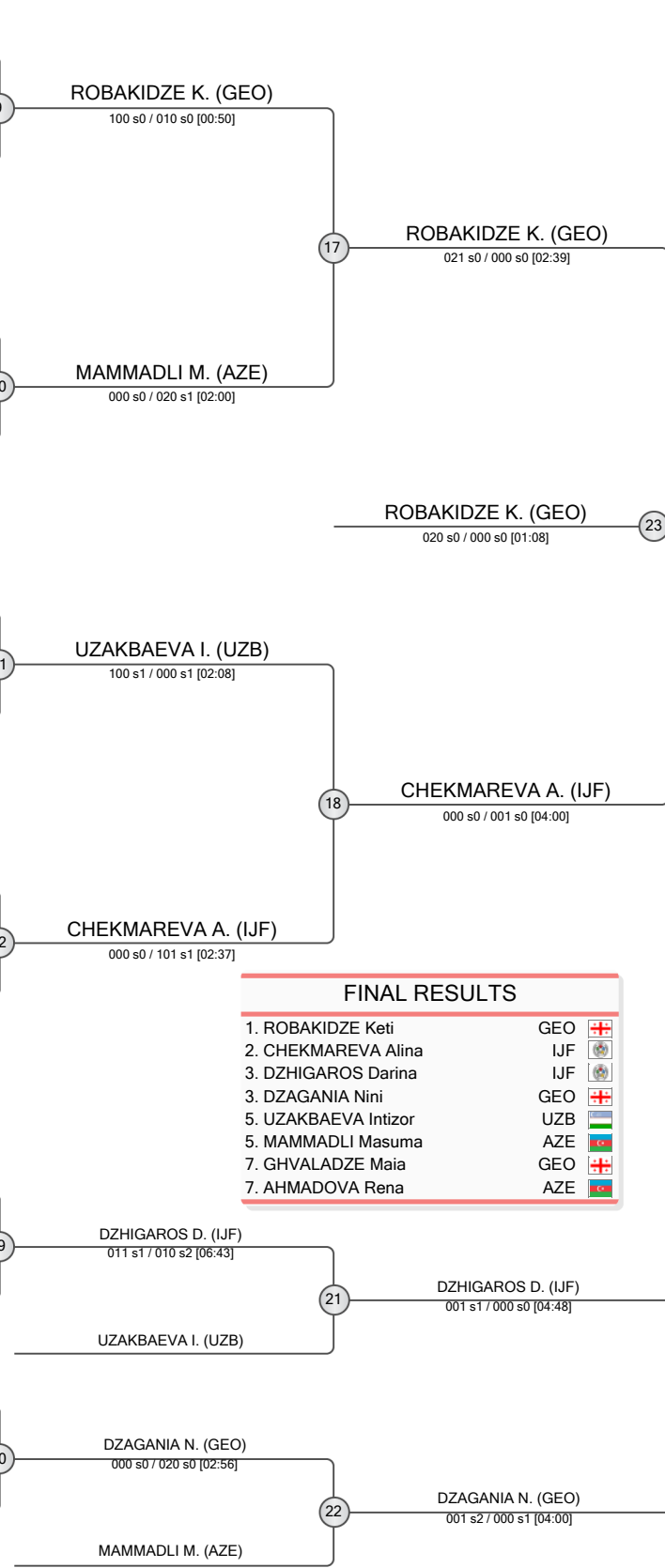
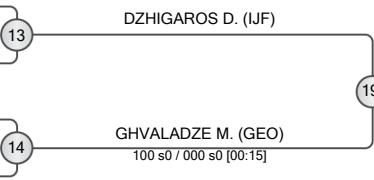

FINAL RESULTS		
1.	ROBAKIDZE Ketii	GEO
2.	CHEKMAREVA Alina	IJF
3.	DZHIGAROS Darina	IJF
3.	DZAGANIA Nini	GEO
5.	UZAKBAEVA Intizor	UZB
5.	MAMMADLI Masuma	AZE
7.	GHVALADZE Maia	GEO
7.	AHMADOVA Rena	AZE





Tbilisi Millennium Team Cadet European Cup 2025

Georgia, Tbilisi, 12-13 Apr 2025

+ 70 kg

Women (9)

POOL A

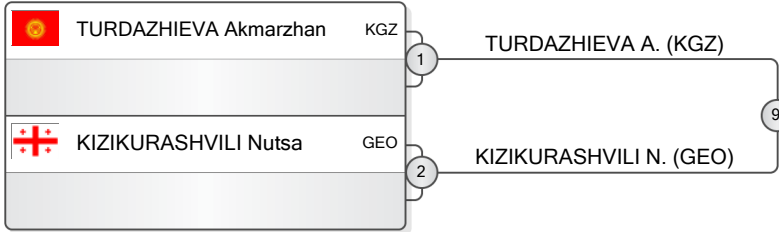

POOL B

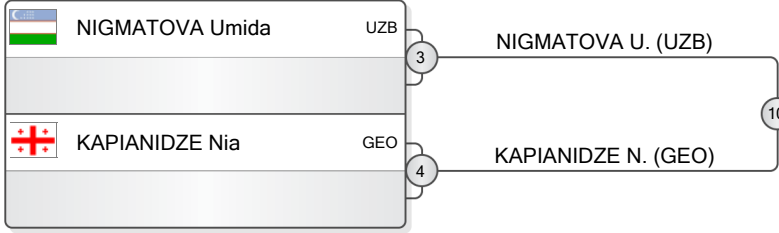

POOL C

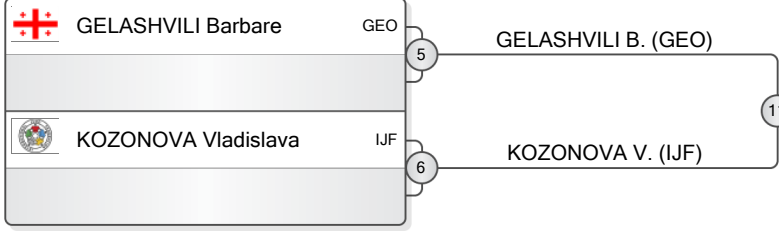

POOL D

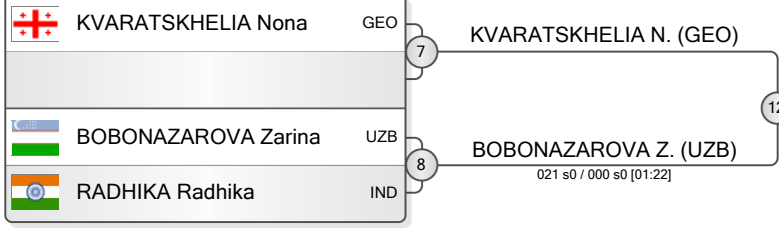

REPECHAGE

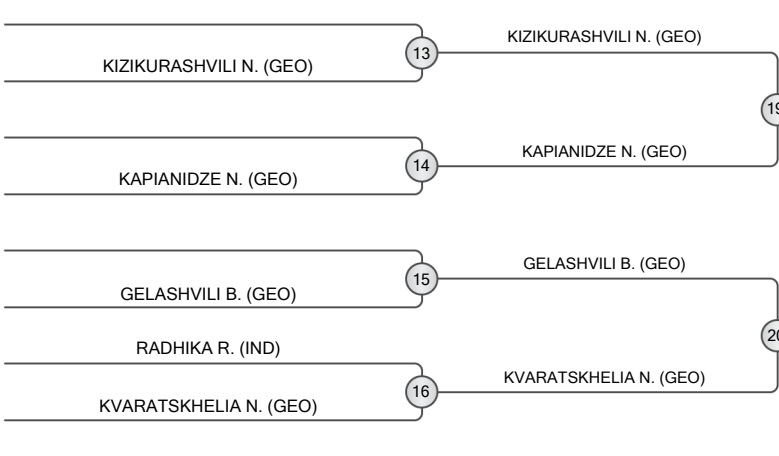

BOBONAZAROVA Z. (UZB) 000 s0 / 100 s0 [01:01]

BOBONAZAROVA Z. (UZB) 000 s1 / 100 s0 [01:23]

FINAL RESULTS		
1.	BOBONAZAROVA Zarina	UZB
2.	NIGMATOVA Umida	UZB
3.	KOZONOVA Vladislava	IJF
3.	TURDAZHIEVA Akmarzhan	KGZ
5.	KAPIANIDZE Nia	GEO
5.	KVARATSKHELIA Nona	GEO

