



Istanbul Junior European Cup 2025

Türkiye, İstanbul, 3-4 May 2025

-60 kg

Men (52)

POOL A

ALAOUİ CHERİFİ Ahmed MAR	1	ALAOUİ CHERİFİ A. (MAR)
ROSADO LOPEZ Rodrigo ESP	2	ROSADO LOPEZ R. (ESP)
KALİASHVİLİ Luka GEO	3	ZURNACHAN H. (IJF)
ZURNACHAN Hryhory IJF	3	ZURNACHAN H. (IJF)
WALİNGA Ruben NED	4	SYNOLD R. (FRA)
VURAL Mert Efe TUR	4	SYNOLD R. (FRA)
SYNOLD Raphael FRA	4	SYNOLD R. (FRA)
MATSUNAGA Retsu JPN	5	MATSUNAGA R. (JPN)
ISKANDAROV Mirkhalig AZE	6	ISKANDAROV M. (AZE)
ALAGOZ Ozgur TUR	6	ISKANDAROV M. (AZE)
MUNKHJARGAL Tergelsar MGL	7	SULTANKHAN D. (KAZ)
SULTANKHAN Danil KAZ	7	SULTANKHAN D. (KAZ)
PALA Necdet Salih TUR	8	PALA N. (TUR)

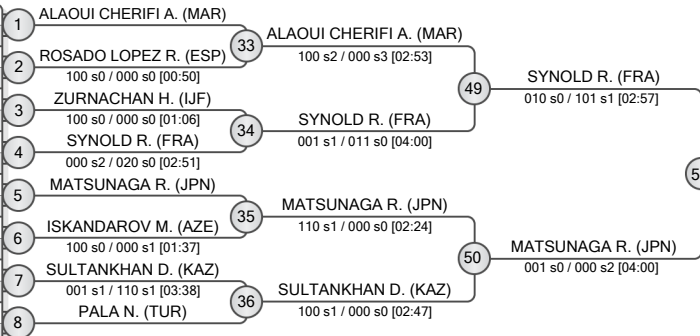

POOL B

EBERHARDT Pierre FRA	9	EBERHARDT P. (FRA)
BASSI Thibaud SUI	10	BASSI T. (SUI)
YILDIZ Alisan TUR	10	BASSI T. (SUI)
MIRZAZADA Aykhan AZE	11	MIRZAZADA A. (AZE)
KADZHAKOV Kandildzhon TJK	11	MIRZAZADA A. (AZE)
ZHAKYPKOZHIN Yeraly KAZ	12	ZHAKYPKOZHIN Y. (KAZ)
GARAYEV Farid AZE	13	GARAYEV F. (AZE)
TURKMAN Tuncay TUR	14	TURKMAN T. (TUR)
IBROKHIMZHON UULU Mukhamadali KGZ	14	TURKMAN T. (TUR)
SZEKELY Botond ROU	15	SZEKELY B. (ROU)
UZUN Yusuf Can TUR	15	SZEKELY B. (ROU)
BACHOSHVILI Shota GEO	16	CHINZORIG B. (MGL)
CHINZORIG Bodiragchaa MGL	16	CHINZORIG B. (MGL)

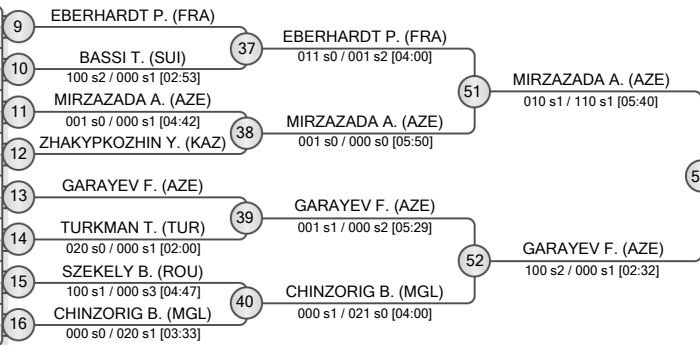

POOL C

TAKAKI Lucas BRA	17	TAKAKI L. (BRA)
MAMISHOV Nihad AZE	18	MAMISHOV N. (AZE)
ISIK Emin TUR	18	MAMISHOV N. (AZE)
TASCI Efecan TUR	19	TASCI E. (TUR)
TANGATKAN Dias KAZ	19	TASCI E. (TUR)
CHANKSELIANI Giorgi GEO	20	CHANKSELIANI G. (GEO)
UYAR Kayra NED	20	CHANKSELIANI G. (GEO)
SHAMSOV Ikrom TJK	21	SHAMSOV I. (TJK)
KUCHKAROV Samariddin UZB	22	CARGNELLI H. (FRA)
CARGNELLI Hadrien FRA	22	CARGNELLI H. (FRA)
TSEDENSONOM Dovchin MGL	23	KIBAROGLU R. (TUR)
KIBAROGLU Ramazan TUR	23	KIBAROGLU R. (TUR)
KARATKEVICH Mikhail IJF	24	KARATKEVICH M. (IJF)

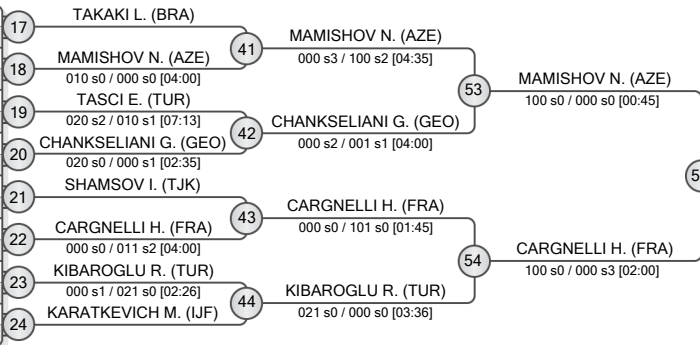

POOL D

TOMANEK Jozef SVK	25	TOMANEK J. (SVK)
OMANADZE Luka GEO	26	OMANADZE L. (GEO)
BENLAHMER Mohamed FRA	26	OMANADZE L. (GEO)
GUNTER Ibrahim TUR	27	HURKAYEU K. (IJF)
HURKAYEU Kanstantsin IJF	27	HURKAYEU K. (IJF)
ANARBAEV Musulmanbek KGZ	28	BALGABAYEV B. (KAZ)
BALGABAYEV Batyrkhan KAZ	28	BALGABAYEV B. (KAZ)
SILVA Joao Pedro BRA	29	SILVA J. (BRA)
PANAİT Alexandru ROU	30	GUL F. (TUR)
GUL Furkan Salih TUR	30	GUL F. (TUR)
OBA Sefer TUR	31	MAMISHOV M. (AZE)
MAMISHOV Mahammad AZE	31	MAMISHOV M. (AZE)
URANBAATAR Sanchirkhuu MGL	32	URANBAATAR S. (MGL)

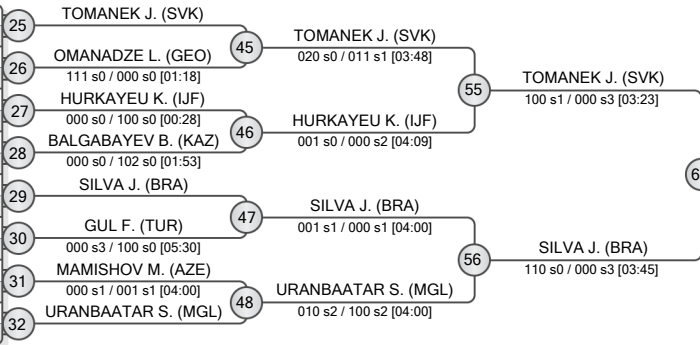

REPECHAGE

ISKANDAROV M. (AZE)	61	ISKANDAROV M. (AZE)
TURKMAN T. (TUR)	62	TURKMAN T. (TUR)
ISIK E. (TUR)	62	TURKMAN T. (TUR)
TAKAKI L. (BRA)	63	TAKAKI L. (BRA)
OMANADZE L. (GEO)	64	OMANADZE L. (GEO)

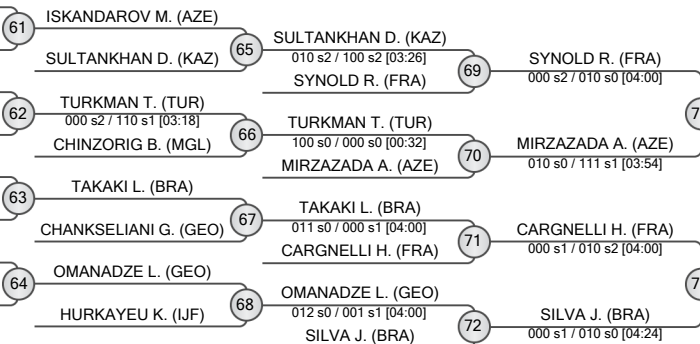

FINAL RESULTS		
1. MATSUNAGA Retsu	JPN	
2. TOMANEK Jozef	SVK	
3. MAMISHOV Nihad	AZE	
3. GARAYEV Farid	AZE	
5. MIRZAZADA Aykhan	AZE	
5. CARGNELLI Hadrien	FRA	
7. SYNOLD Raphael	FRA	
7. SILVA Joao Pedro	BRA	





Istanbul Junior European Cup 2025

Türkiye, İstanbul, 3-4 May 2025

-66 kg

Men (56)

POOL A

1	NOBREGA Bruno (BRA)	2	GIGAURI T. (GEO)	33	NOBREGA B. (BRA)
2	IACOMI Vladimir (MDA)	3	TANAKA R. (JPN)	34	YERZHANOV Y. (KAZ)
3	GIGAURI Tornike (GEO)	4	YERZHANOV Y. (KAZ)	35	NESIC R. (FRA)
4	SONMEZ Ali (TUR)	5	BITROU A. (MAR)	36	NAGHIYEV N. (AZE)
5	TANAKA Ryuki (JPN)	6	NESIC R. (FRA)	37	SABASHVILI S. (GEO)
6	YERZHANOV Yerassyl (KAZ)	7	ASSANALIYEV B. (ESP)	38	OROZMAMATOV A. (KGZ)
7	TAGHIZADEH Ali (IRI)	8	NAGHIYEV N. (AZE)	39	MAITIN S. (SUI)
8	BITROU Amine (MAR)		MACHALIKASHVILI Beka (GEO)	40	IMRANOV N. (AZE)

POOL B

9	NEVES Ernane (BRA)	10	SABASHVILI S. (GEO)	37	SABASHVILI S. (GEO)
10	SABASHVILI Saba (GEO)	11	OROZMAMATOV A. (KGZ)	38	OROZMAMATOV A. (KGZ)
11	RICO PEDRIDO Pablo (ESP)	12	HERMSEN D. (NED)	39	MAITIN S. (SUI)
12	OROZMAMATOV Adis (KGZ)	13	MAITIN S. (SUI)	40	IMRANOV N. (AZE)
13	GOKBULUT Baris Bugra (TUR)	14	SIMSEK M. (TUR)	41	ISKAKOV N. (KAZ)
14	GABRIEL Igor (POL)	15	ZHOLEKESH A. (KAZ)	42	SULEYMANLI N. (AZE)
15	HERMSEN Dani (NED)	16	IMRANOV N. (AZE)	43	KARELI D. (GEO)
16	MAITIN Stevan (SUI)		VALASEVICH Matsfei (IJF)	44	CHYNYBEKOV K. (KGZ)

POOL C

17	HAMROYEV Dilshodbek (UZB)	18	ISKAKOV N. (KAZ)	41	ISKAKOV N. (KAZ)
18	FLUM Fabio (SUI)	19	CATALA BORI J. (ESP)	42	SULEYMANLI N. (AZE)
19	CATALA BORI Jorge (ESP)	20	SULEYMANLI N. (AZE)	43	KARELI D. (GEO)
20	ERTEM Mehmet Sahin (TUR)	21	CAKIR A. (TUR)	44	CHYNYBEKOV K. (KGZ)
21	SULEYMANLI Nijat (AZE)	22	KARELI D. (GEO)	45	KHIDASHELI T. (GEO)
22	GUSHKOV Stilyan (BUL)	23	CHYNYBEKOV K. (KGZ)	46	ZHUBATKANOV A. (KAZ)
23	CAKIR Abdulsamet (TUR)	24	SHTYK D. (IJF)	47	MORARU A. (MDA)
24	KARELI Davit (GEO)		BATTSOOJ Batzorig (MGL)	48	ARAVIASHVILI S. (GEO)

POOL D

25	KHIDASHELI Tengiz (GEO)	26	MIRANDA GALINDO E. (ESP)	45	KHIDASHELI T. (GEO)
26	LIRA Joao (BRA)	27	SYCHOU M. (IJF)	46	ZHUBATKANOV A. (KAZ)
27	MIRANDA GALINDO Eduardo (ESP)	28	ZHUBATKANOV A. (KAZ)	47	MORARU A. (MDA)
28	DINC Tunahan (TUR)	29	MUCIK H. (TUR)	48	ARAVIASHVILI S. (GEO)
29	SYCHOU Matvei (IJF)	30	MORARU A. (MDA)	49	NOBREGA B. (BRA)
30	PAISHANBIEV Oshurmamad (TJK)	31	ISATAEV N. (KAZ)	50	NAGHIYEV N. (AZE)
31	ZHUBATKANOV Akylyzhan (KAZ)	32	ARAVIASHVILI S. (GEO)	51	SABASHVILI S. (GEO)
32	MUCIK Hilmi (TUR)		PRED ALEXANDRU (ROU)	52	IMRANOV N. (AZE)

REPECHAGE

61	GIGAURI T. (GEO)	62	ZHOLEKESH A. (KAZ)	63	ISKAKOV N. (KAZ)	64	PAISHANBIEV O. (TJK)
65	YERZHANOV Y. (KAZ)	66	MAITIN S. (SUI)	67	SULEYMANLI N. (AZE)	68	PAISHANBIEV O. (TJK)
69	NAGHIYEV N. (AZE)	70	SABASHVILI S. (GEO)	71	ISKAKOV N. (KAZ)	72	ISATAEV N. (KAZ)
75	SABASHVILI S. (GEO)	76	ISATAEV N. (KAZ)	77	ZHUBATKANOV A. (KAZ)	78	NOBREGA B. (BRA)

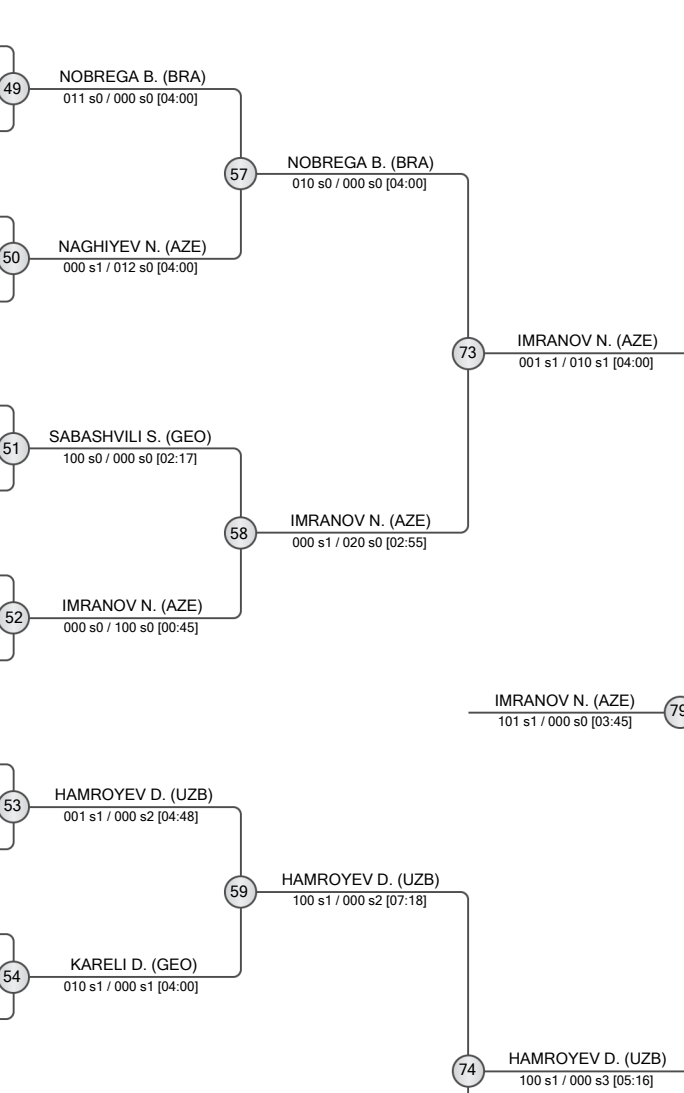

FINAL RESULTS		
1.	IMRANOV Nizami	AZE
2.	HAMROYEV Dilshodbek	UZB
3.	ZHUBATKANOV Akylyzhan	KAZ
3.	NOBREGA Bruno	BRA
5.	SABASHVILI Saba	GEO
5.	ISKAKOV Nursultan	KAZ
7.	NAGHIYEV Nijat	AZE
7.	PAISHANBIEV Oshurmamad	TJK





Istanbul Junior European Cup 2025

Türkiye, İstanbul, 3-4 May 2025

-73 kg

Men (62)

POOL A

1	LAHMOURI N. (MAR)	33	LAHMOURI N. (MAR)		
2	MURESAN M. (ROU)	001 s2 / 000 s0 [04:00]	33	LAHMOURI N. (MAR)	110 s0 / 010 s3 [06:00]
3	TELMANOV I. (UZB)	101 s1 / 000 s2 [03:57]	34	TELMANOV I. (UZB)	100 s0 / 000 s0 [01:23]
4	GOKER Y. (TUR)	000 s0 / 020 s0 [02:18]	35	ZAKIROV M. (KAZ)	010 s1 / 000 s2 [07:09]
5	ZAKIROV M. (KAZ)	001 s1 / 000 s2 [08:16]	36	TURGUTLU A. (TUR)	102 s0 / 000 s1 [03:42]
6	ALKHOU S. (IJF)	000 s1 / 101 s0 [02:46]	37	JEAN P. (FRA)	100 s0 / 000 s1 [01:21]
7	TURGUTLU A. (TUR)	101 s1 / 010 s2 [03:55]	38	YAHYAYEV N. (AZE)	111 s0 / 000 s0 [02:21]
8	SHIKHALIYEV T. (AZE)	010 s2 / 000 s1 [04:00]	39	MORBEDADZE N. (GEO)	010 s0 / 020 s2 [04:20]

POOL B

9	JEAN P. (FRA)	100 s0 / 000 s1 [01:21]	40	JAFAROV M. (AZE)	010 s0 / 000 s1 [04:00]
10	KAZIMIERCZAK A. (POL)	001 s1 / 000 s1 [04:00]	41	MAMMADLI F. (AZE)	000 s0 / 010 s1 [04:00]
11	YAHYAYEV N. (AZE)	111 s0 / 000 s0 [02:21]	42	SAFAROV B. (UZB)	000 s0 / 100 s1 [02:34]
12	RYSMAKHAN T. (KAZ)	100 s0 / 000 s0 [00:21]	43	BROSSEAU K. (FRA)	000 s1 / 010 s1 [05:42]
13	CADIGNAN N. (FRA)	100 s0 / 000 s0 [00:57]	44	TALAKA Y. (IJF)	100 s0 / 000 s0 [00:21]
14	MORBEDADZE N. (GEO)	100 s0 / 000 s0 [00:14]	45	SKERLEV V. (BUL)	011 s0 / 000 s0 [04:00]
15	JAFAROV M. (AZE)	000 s1 / 100 s0 [01:59]	46	RZAYEV S. (AZE)	020 s0 / 000 s0 [02:22]
16	VALIZADEH A. (IRI)	000 s2 / 010 s1 [04:00]	47	ARAKAWA R. (JPN)	000 s0 / 101 s1 [02:46]

POOL C

17	NOLASCO M. (BRA)	000 s2 / 010 s1 [04:00]	48	JACOBS I. (MAR)	000 s2 / 112 s2 [03:22]
18	MAMMADLI F. (AZE)	000 s0 / 010 s1 [04:00]	49	TELMANOV I. (UZB)	000 s2 / 100 s0 [03:30]
19	SAFAROV B. (UZB)	000 s1 / 020 s0 [01:37]	50	TURGUTLU A. (TUR)	000 s0 / 100 s0 [01:15]
20	ABAY I. (KAZ)	010 s2 / 000 s1 [05:26]	51	JEAN P. (FRA)	100 s0 / 000 s2 [02:54]
21	YUSUBOV A. (AZE)	101 s1 / 000 s0 [02:27]	52	MORBEDADZE N. (GEO)	001 s2 / 000 s0 [04:08]
22	BROSSEAU K. (FRA)	000 s1 / 010 s1 [05:42]	53	SAFAROV B. (UZB)	000 s0 / 100 s1 [02:34]
23	TALAKA Y. (IJF)	011 s1 / 100 s0 [02:32]	54	BROSSEAU K. (FRA)	020 s0 / 001 s0 [03:18]
24	SENGUR B. (TUR)	100 s2 / 000 s3 [08:41]	55	SKERLEV V. (BUL)	100 s2 / 000 s3 [05:09]

POOL D

25	SKERLEV V. (BUL)	011 s0 / 000 s0 [04:00]	56	ARAKAWA R. (JPN)	100 s1 / 000 s0 [02:55]
26	DUBOVIK A. (IJF)	010 s1 / 000 s2 [04:00]	57	TELMANOV I. (UZB)	100 s0 / 000 s1 [02:08]
27	RZAYEV S. (AZE)	020 s0 / 000 s0 [02:22]	58	JEAN P. (FRA)	100 s1 / 000 s3 [07:18]
28	CHANSSEAUME C. (FRA)	100 s2 / 000 s3 [03:23]	59	SAFAROV B. (UZB)	020 s1 / 010 s2 [06:03]
29	ARAKAWA R. (JPN)	000 s0 / 101 s1 [02:46]	60	ARAKAWA R. (JPN)	000 s1 / 001 s0 [04:00]
30	ANDRADE J. (BRA)	000 s1 / 001 s1 [06:25]	61	GOKER Y. (TUR)	000 s1 / 100 s0 [03:02]
31	ZOBA CASI D. (FRA)	020 s0 / 000 s1 [02:37]	62	KAZIMIERCZAK A. (POL)	000 s0 / 020 s0 [02:13]
32	JACOBS I. (MAR)	000 s2 / 112 s2 [03:22]	63	ABAY I. (KAZ)	000 s1 / 001 s1 [05:29]

REPECHAGE

61	GOKER Y. (TUR)	000 s1 / 100 s0 [03:02]	65	LAHMOURI N. (MAR)	000 s0 / 100 s0 [01:01]
62	KAZIMIERCZAK A. (POL)	000 s0 / 020 s0 [02:13]	66	YAHYAYEV N. (AZE)	000 s2 / 110 s1 [03:54]
63	ABAY I. (KAZ)	000 s1 / 001 s1 [05:29]	67	MAMMADLI F. (AZE)	110 s0 / 000 s0 [00:51]
64	ANDRADE J. (BRA)	000 s1 / 001 s1 [06:25]	68	ZOBA CASI D. (FRA)	000 s1 / 010 s0 [04:40]
65	LAHMOURI N. (MAR)	000 s0 / 100 s0 [01:01]	69	TURGUTLU A. (TUR)	000 s1 / 010 s2 [04:00]
66	YAHYAYEV N. (AZE)	000 s2 / 110 s1 [03:54]	70	MORBEDADZE N. (GEO)	020 s0 / 000 s0 [01:24]
67	MAMMADLI F. (AZE)	110 s0 / 000 s0 [00:51]	71	BROSSEAU K. (FRA)	000 s0 / 001 s0 [04:00]
68	ZOBA CASI D. (FRA)	000 s1 / 010 s0 [04:40]	72	ZOBA CASI D. (FRA)	010 s2 / 000 s0 [04:00]

FINAL RESULTS

1. ARAKAWA Ryusei JPN
2. JEAN Peter FRA
3. SAFAROV Bunyod UZB
3. BROSSEAU Kassim FRA
5. YAHYAYEV Nihad AZE
5. TELMANOV Inoyat UZB
7. TURGUTLU Abdullah TUR
7. ZOBA CASI Desir FRA





Istanbul Junior European Cup 2025

Türkiye, İstanbul, 3-4 May 2025

-81 kg

Men (62)

POOL A

1	TROMBINI Enzo (BRA)	33	TROMBINI E. (BRA)
2	OTEGEN Arkhat (KAZ)	000 s0 / 110 s1 [03:28]	000 s0 / 110 s1 [03:28]
3	KAPANADZE Giorgi (GEO)	100 s0 / 000 s0 [00:33]	100 s0 / 000 s0 [00:33]
4	SAIDZODA Sadullo (TKJ)	100 s0 / 100 s0 [01:18]	100 s0 / 100 s0 [01:18]
5	SABIC Bakir (BIH)	000 s0 / 100 s0 [00:52]	000 s0 / 100 s0 [00:52]
6	TARGULIYEV Nahid (AZE)	000 s0 / 100 s0 [00:52]	000 s0 / 100 s0 [00:52]
7	RUDENKO Tymofii (ESP)	000 s0 / 010 s1 [04:00]	000 s0 / 010 s1 [04:00]
8	SZULIK Szymon (POL)	011 s0 / 001 s1 [04:57]	011 s0 / 001 s1 [04:57]
9	MELNIKAU Danila (IJF)	000 s0 / 100 s0 [02:17]	000 s0 / 100 s0 [02:17]
10	KVELASHVILI I. (GEO)	000 s0 / 100 s0 [02:17]	000 s0 / 100 s0 [02:17]
11	KNOPPERSEN Kai (NED)	000 s0 / 100 s0 [00:42]	000 s0 / 100 s0 [00:42]
12	ODA Akiyumi (JPN)	100 s0 / 000 s1 [05:26]	100 s0 / 000 s1 [05:26]
13	PAPIASHVILI Roman (GEO)	000 s1 / 003 s2 [04:00]	000 s1 / 003 s2 [04:00]
14	ARI Emir Selim (TUR)		

POOL B

9	ABBASOV M. (AZE)	000 s2 / 001 s1 [06:41]	000 s2 / 001 s1 [06:41]
10	ASHRAFI Mohammad Amin (IRI)	000 s0 / 022 s0 [03:53]	000 s0 / 022 s0 [03:53]
11	GVELESIANI Mate (GEO)	001 s1 / 000 s0 [04:00]	001 s1 / 000 s0 [04:00]
12	AKHLOURI Sandro (GEO)	000 s0 / 102 s0 [01:52]	000 s0 / 102 s0 [01:52]
13	TOPCU Melih (TUR)	001 s1 / 000 s0 [04:00]	001 s1 / 000 s0 [04:00]
14	AVDEJEVS Aleksandrs (LAT)	100 s0 / 000 s1 [00:25]	100 s0 / 000 s1 [00:25]
15	MARTINS Rafael (BRA)	021 s0 / 000 s1 [02:59]	021 s0 / 000 s1 [02:59]
16	TCHIGLADZE Zurab (GEO)	100 s1 / 000 s2 [05:54]	100 s1 / 000 s2 [05:54]
17	BELLEVAL Jawanys (FRA)	001 s1 / 000 s0 [04:00]	001 s1 / 000 s0 [04:00]
18	MIHALY Hunor (ROU)	020 s0 / 000 s2 [03:43]	020 s0 / 000 s2 [03:43]
19	ANARBEKOV Arsen (KGZ)	001 s2 / 000 s0 [06:36]	001 s2 / 000 s0 [06:36]
20	CANELLO Joao Pedro (BRA)	100 s0 / 000 s1 [01:43]	100 s0 / 000 s1 [01:43]
21	AKTAS Yunus Emre (TUR)		
22	SOLANKI Aditya (IND)		
23	NERGUI Jangarai (MGL)		

POOL C

17	TARKOWSKI Fabrycjusz (POL)	020 s0 / 000 s0 [00:55]	020 s0 / 000 s0 [00:55]
18	MELNIC Emilian (MDA)	011 s1 / 000 s1 [04:00]	011 s1 / 000 s1 [04:00]
19	RESHIEV Abdulmalik (TUR)	002 s2 / 000 s0 [04:00]	002 s2 / 000 s0 [04:00]
20	KULTAEV Aktilek (KGZ)	011 s1 / 000 s1 [04:00]	011 s1 / 000 s1 [04:00]
21	BADRAKH Shinetulga (MGL)	000 s0 / 011 s2 [04:00]	000 s0 / 011 s2 [04:00]
22	VALCHEV Emil (BUL)	010 s0 / 000 s2 [08:34]	010 s0 / 000 s2 [08:34]
23	VAKHTANGADZE Tornike (GEO)	100 s1 / 000 s0 [02:35]	100 s1 / 000 s0 [02:35]
24	BALGABAY Dosbol (KAZ)	000 s3 / 100 s1 [04:26]	000 s3 / 100 s1 [04:26]
25	PAPUKISHVILI Giorgi (GEO)	001 s0 / 000 s1 [06:14]	001 s0 / 000 s1 [06:14]
26	COSTA Silas (BRA)	102 s0 / 000 s0 [02:15]	102 s0 / 000 s0 [02:15]
27	HARBACHOU Yauheni (IJF)		
28	LADO Akos (ROU)		
29	GARAYEV Roman (AZE)		
30	MISHVELIDZE Giorgi (GEO)		
31	O'NEAL-NARCIS Corey (GBR)		

POOL D

25	MEDEIROS NETO Antonio (BRA)	000 s3 / 100 s1 [08:41]	000 s3 / 100 s1 [08:41]
26	MURATOV Nurmukhammed (KGZ)	000 s0 / 110 s0 [01:38]	000 s0 / 110 s0 [01:38]
27	BAKHTADZE Tsoetne (GEO)	000 s0 / 100 s0 [02:09]	000 s0 / 100 s0 [02:09]
28	MEMETOV Robert (IF2)	100 s2 / 000 s1 [02:41]	100 s2 / 000 s1 [02:41]
29	ENERIZ GARCIA Arkaitz (ESP)	001 s2 / 000 s2 [04:22]	001 s2 / 000 s2 [04:22]
30	IBADLI Jasur (AZE)	000 s0 / 100 s1 [04:00]	000 s0 / 100 s1 [04:00]
31	MUXIBIDDINOV Samariddin (UZB)	100 s0 / 000 s0 [00:40]	100 s0 / 000 s0 [00:40]
32	TCHIKADZE Saba (GEO)	100 s1 / 000 s3 [02:55]	100 s1 / 000 s3 [02:55]
33	TUGULEA Maxim (ROU)	000 s0 / 000 s0 [00:00]	000 s0 / 000 s0 [00:00]
34	ZAITSAU Mikita (IJF)	101 s1 / 000 s2 [03:36]	101 s1 / 000 s2 [03:36]
35	LE GALLOU Liam (FRA)	001 s0 / 101 s2 [04:22]	001 s0 / 101 s2 [04:22]
36	SAHIN Ibrahim Melih (TUR)		
37	MAKHMADBEKOV Muslim (TKJ)		
38	DURDEVIC Adrian (BIH)		
39	MADENOV Muradali (KAZ)		
40	ONIANI Luka (GEO)		

REPECHAGE

61	RUDENKO T. (ESP)	000 s0 / 101 s1 [02:26]	000 s0 / 101 s1 [02:26]
62	KVELASHVILI I. (GEO)	100 s0 / 000 s0 [00:00]	100 s0 / 000 s0 [00:00]
63	TOPCU M. (TUR)	000 s1 / 100 s0 [01:29]	000 s1 / 100 s0 [01:29]
64	AVDEJEVS A. (LAT)	000 s0 / 100 s0 [00:00]	000 s0 / 100 s0 [00:00]
65	MELNIC E. (MDA)	000 s0 / 100 s0 [00:28]	000 s0 / 100 s0 [00:28]
66	BAKHTADZE T. (GEO)	000 s1 / 100 s0 [01:58]	000 s1 / 100 s0 [01:58]
67	MURATOV N. (KGZ)	000 s1 / 100 s1 [05:36]	000 s1 / 100 s1 [05:36]
68	KVELASHVILI I. (GEO)	020 s0 / 000 s0 [02:21]	020 s0 / 000 s0 [02:21]
69	ODA A. (JPN)	000 s2 / 100 s1 [03:30]	000 s2 / 100 s1 [03:30]
70	TROMBINI E. (BRA)	000 s1 / 100 s0 [01:29]	000 s1 / 100 s0 [01:29]
71	ABBASOV M. (AZE)	020 s1 / 000 s1 [03:07]	020 s1 / 000 s1 [03:07]
72	IBADLI J. (AZE)	000 s1 / 010 s2 [06:39]	000 s1 / 010 s2 [06:39]
73	ABBASOV M. (AZE)	000 s0 / 100 s1 [01:24]	000 s0 / 100 s1 [01:24]
74	TCHIGLADZE Z. (GEO)	000 s0 / 100 s0 [00:00]	000 s0 / 100 s0 [00:00]
75	ABBASOV M. (AZE)	000 s2 / 100 s1 [03:30]	000 s2 / 100 s1 [03:30]
76	MELNIC E. (MDA)	000 s1 / 010 s0 [04:00]	000 s1 / 010 s0 [04:00]
77	BAKHTADZE T. (GEO)	000 s2 / 000 s2 [04:00]	000 s2 / 000 s2 [04:00]
78	MURATOV N. (KGZ)	000 s2 / 000 s2 [04:00]	000 s2 / 000 s2 [04:00]
79	IBADLI J. (AZE)	010 s1 / 000 s1 [04:48]	010 s1 / 000 s1 [04:48]

FINAL RESULTS

1. SZULIK Szymon (POL)
2. TARKOWSKI Fabrycjusz (POL)
3. ABBASOV Mehdi (AZE)
3. AKHLOURI Sandro (GEO)
5. MEMETOV Robert (IF2)
5. IBADLI Jasur (AZE)
7. TROMBINI Enzo (BRA)
7. KULTAEV Aktilek (KGZ)





Istanbul Junior European Cup 2025

Türkiye, İstanbul, 3-4 May 2025

-90 kg

Men (46)

POOL A

1	GHIMBOVSCHI Vadim	MDA
2	KRYLOV Daniil	KAZ
3	KESKIN Berat Abdullah	TUR
4	GVELESIANI Saba	GEO
5	GLIGA David	ROU
6	KAIS Rayan	FRA
7	KARELISHVILI Luka	GEO
8	MOHEBI Abolfazl	IRI
9	NAKHOSTIN Omid	JPN
10	ALIYEV Khayyam	AZE
11	KOMPE Mertcan	TUR
12	CHAPURISHVILI Mate	GEO

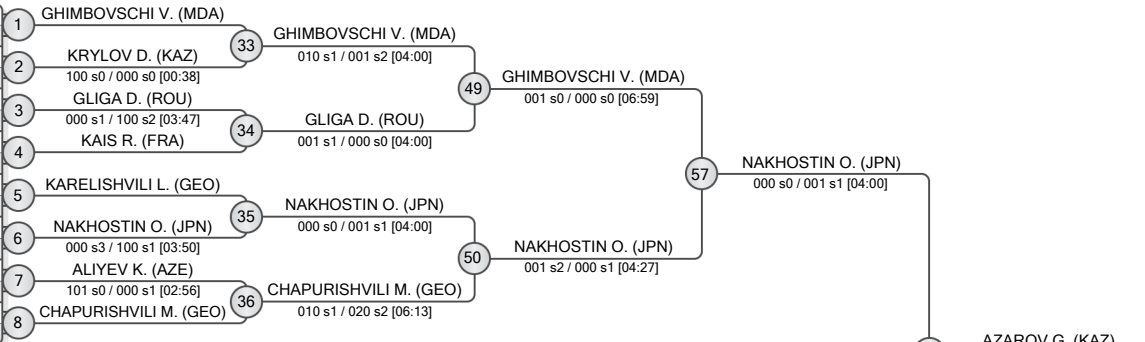

POOL B

9	SEGATELLE Joao	BRA
10	JIKIA Saba	GEO
11	SEYMEN Bekir Taha	TUR
12	JANSEN Dylan	NED
13	MELISOV Daniir	KGZ
14	BOLDYRIEV Aleksii	POL
15	KOVAL Dzmityr	IJF
16	ENZ Lorenzo	SUI
17	KAVTARASHVILI Irakli	GEO
18	ERKINOV Sardorbek	UZB
19	AZAROV Gleb	KAZ

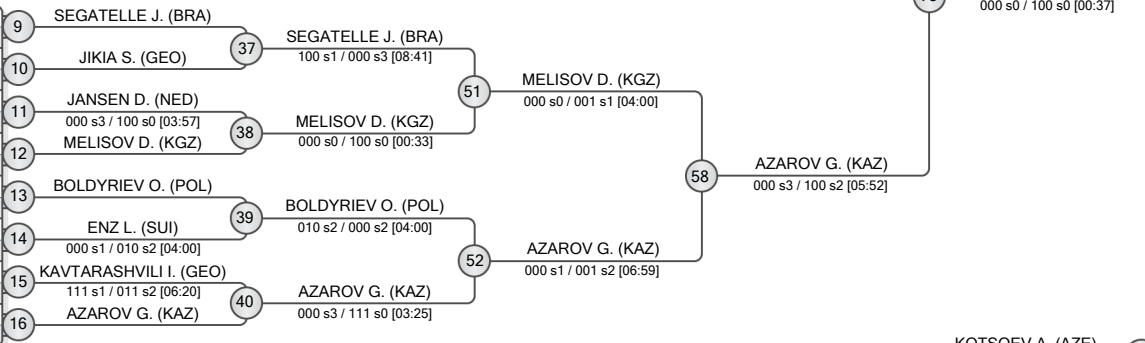

POOL C

17	BARBOSA Jesse	BRA
18	DURSON Fatih	TUR
19	CHYZHEVSKYI Ghenadi	MDA
20	TOLEBIULY Yelbossyn	KAZ
21	JAVAKHISHVILI Luka	GEO
22	ALTENA Thijs	NED
23	KOTSOEV Aslan	AZE
24	SHVANGIRADZE Luka	GEO
25	KHASBAATAR Bulgankhuu	MGL
26	KAZIEV Nariman	KGZ
27	TSAKIROV Vasili	GRE
28	GELASHVILI Giorgi	GEO

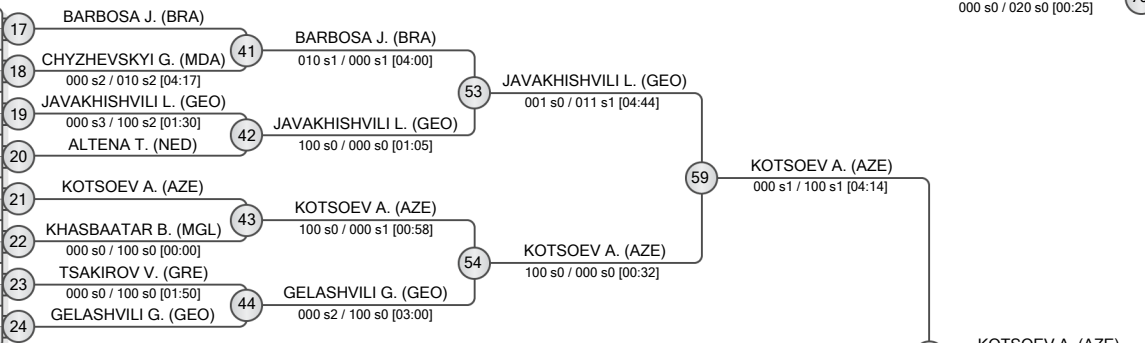

POOL D

25	SAMANOV Alisher	UZB
26	PAPUKISHVILI David	GEO
27	OUBENAISSA Salim	FRA
28	IORGA Fabian	ROU
29	SALOMOV Surush	TJK
30	ATASOGLU Necdet	TUR
31	CHOOPAN Amir Abbas	IRI
32	AGYBAYEV Shakhniyaz	KAZ
33	TEVDORADZE Luka	GEO
34	ALIYEV Janpolad	AZE
35	SJARDIN Kees	NED

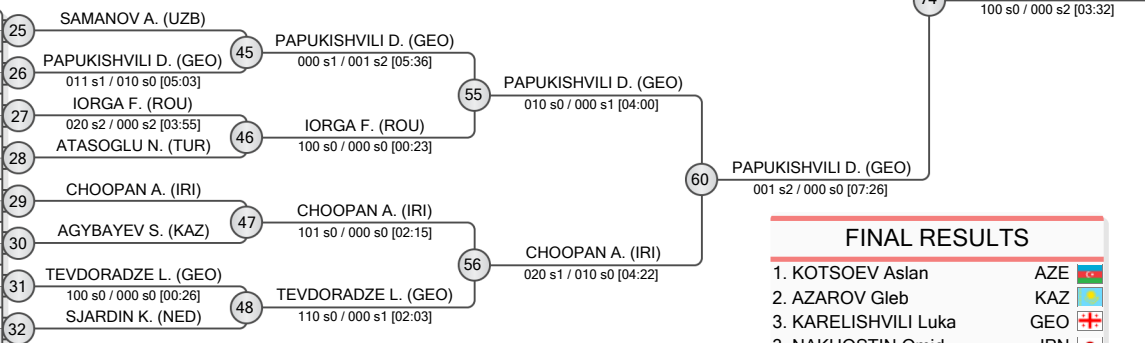

FINAL RESULTS	
1.	KOTSOEV Aslan (AZE)
2.	AZAROV Gleb (KAZ)
3.	KARELISHVILI Luka (GEO)
3.	NAKHOSTIN Omid (JPN)
5.	PAPUKISHVILI David (GEO)
5.	JAVAKHISHVILI Luka (GEO)
7.	KAVTARASHVILI Irakli (GEO)
7.	OUBENAISSA Salim (FRA)

REPECHAGE

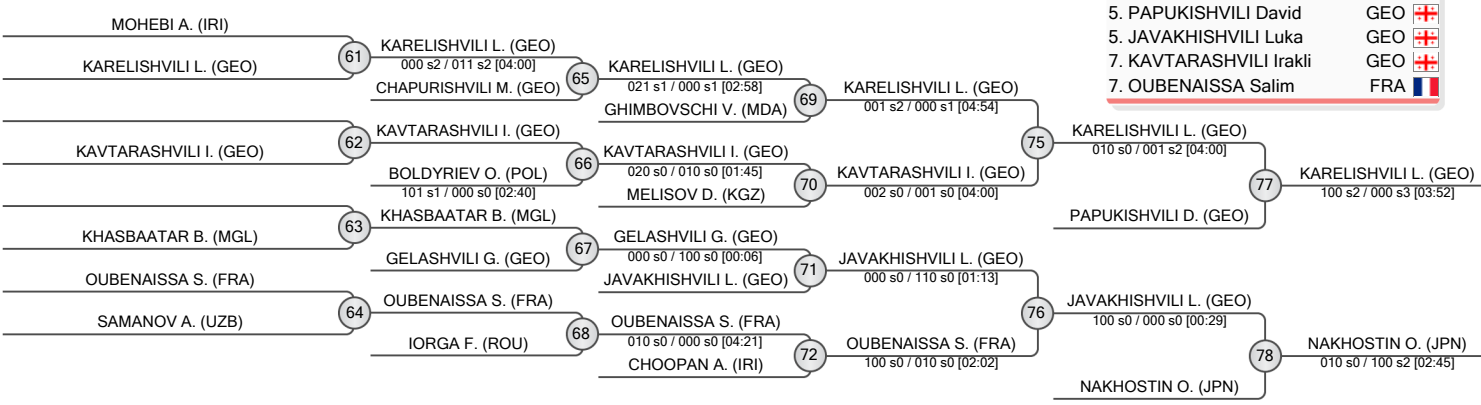



Istanbul Junior European Cup 2025

Türkiye, İstanbul, 3-4 May 2025

-100 kg

Men (39)

POOL A

IRI	NIKSERESHT Ali Reza	1	NIKSERESHT A. (IRI)
BUL	BACHVAROV Dzhani	2	BACHVAROV D. (BUL)
TUR	ZALOGLU Mikail	3	ZALOGLU M. (TUR)
GEO	ZHORZHOLIANI Giorgi	4	ZHORZHOLIANI G. (GEO)
GEO	BENDELIANI Giorgi	5	BENDELIANI G. (GEO)
KAZ	RAIS Bibarys	6	RAIS B. (KAZ)
POL	MARCIN Walenciak	7	MARCIN W. (POL)
TUR	CIRIK Mustafa Enes	8	BERTHELEMY M. (FRA)
FRA	BERTHELEMY Maxence	8	BERTHELEMY M. (FRA)

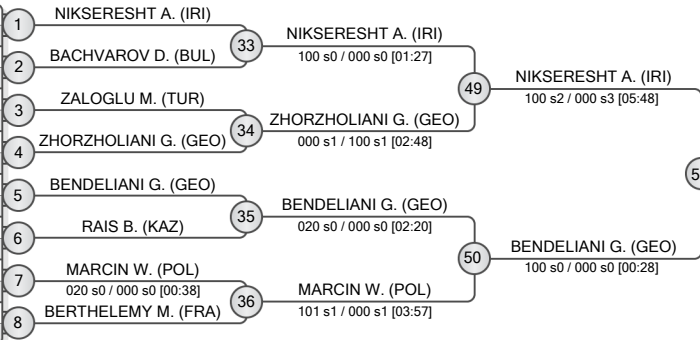

POOL B

POL	KUBIAK Damian	9	KUBIAK D. (POL)
GEO	TCHETCHELASHVILI Aleksandre	10	TCHETCHELASHVILI A. (GEO)
KAZ	YERULANULY Sanzhar	11	GULER M. (TUR)
TUR	GULER Muzaffer	11	GULER M. (TUR)
NED	FRANSENS Leonhard	12	FRANSENS L. (NED)
ROU	PETRE Bogdan	13	PETRE B. (ROU)
TUR	ASKIN Omer Gunes	14	SASAKI Y. (JPN)
JPN	SASAKI Yuto	14	SASAKI Y. (JPN)
AZE	ALIYEV Vidad	15	ALIYEV V. (AZE)
GEO	TSINTSALASHVILI Islam	16	TSINTSALASHVILI I. (GEO)
GEO	TSINTSALASHVILI Islam	16	TSINTSALASHVILI I. (GEO)

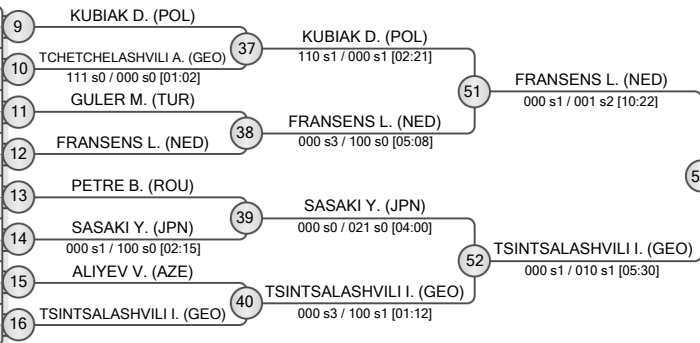

POOL C

BRA	GUIMARAES Matheus	17	GUIMARAES M. (BRA)
ROU	DINCA Alexandru	18	DINCA A. (ROU)
TUR	OZTAS Mevlut	19	HASIC A. (BIH)
BIH	HASIC Amar	19	HASIC A. (BIH)
GEO	JATCHVLIANI Nika	20	JATCHVLIANI N. (GEO)
GEO	EKVTIMISHVILI Luka	21	EKVTIMISHVILI L. (GEO)
AZE	EYVAZLI Huseyn	22	EYVAZLI H. (AZE)
GEO	ZAALISHVILI Nikoloz	23	ZAALISHVILI N. (GEO)
KAZ	LEKER Nursultan	24	ZOIROV M. (UZB)
UZB	ZOIROV Mukhammadali	24	ZOIROV M. (UZB)

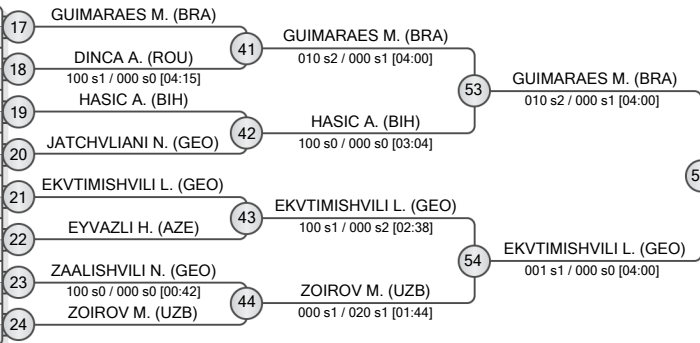

POOL D

BRA	MILANO Gustavo	25	MILANO G. (BRA)
GEO	GABRITCHIDZE Nika	26	GABRITCHIDZE N. (GEO)
KAZ	BIRZHANOV Askar	27	BIRZHANOV A. (KAZ)
TUR	KISA Mehmet	28	BIRZHANOV A. (KAZ)
POL	WACKO Mateusz	28	WACKO M. (POL)
GEO	ALAPISHVILI Nodari	29	ALAPISHVILI N. (GEO)
KGZ	POLTUSHEV Daut	30	MORAU Y. (IJF)
IJF	MORAU Yauheni	30	MORAU Y. (IJF)
TUR	KARA Mert Yasin	31	KARA M. (TUR)
ROU	SANDU Victor	32	SANDU V. (ROU)
ROU	SANDU Victor	32	SANDU V. (ROU)

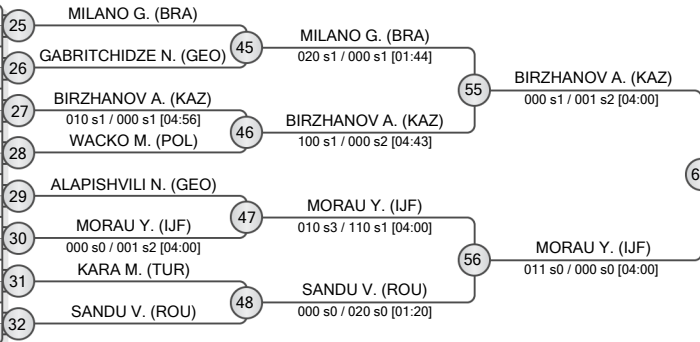

FINAL RESULTS		
1.	BIRZHANOV Askar	KAZ
2.	BENDELIANI Giorgi	GEO
3.	GUIMARAES Matheus	BRA
3.	WACKO Mateusz	POL
5.	TSINTSALASHVILI Islam	GEO
7.	FRANSENS Leonhard	NED
7.	RAIS Bibarys	KAZ
7.	EKVTIMISHVILI Luka	GEO

REPECHAGE

KAZ	RAIS B. (KAZ)	61	RAIS B. (KAZ)
POL	MARCIN W. (POL)	65	MARCIN W. (POL)
TUR	GULER M. (TUR)	62	GULER M. (TUR)
TUR	GULER M. (TUR)	62	GULER M. (TUR)
ROU	DINCA A. (ROU)	63	DINCA A. (ROU)
TUR	KISA M. (TUR)	64	KISA M. (TUR)
POL	WACKO M. (POL)	64	WACKO M. (POL)
POL	WACKO M. (POL)	64	WACKO M. (POL)

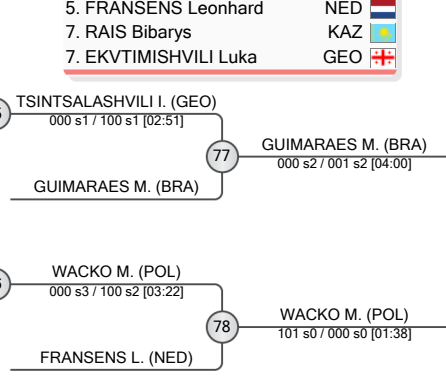
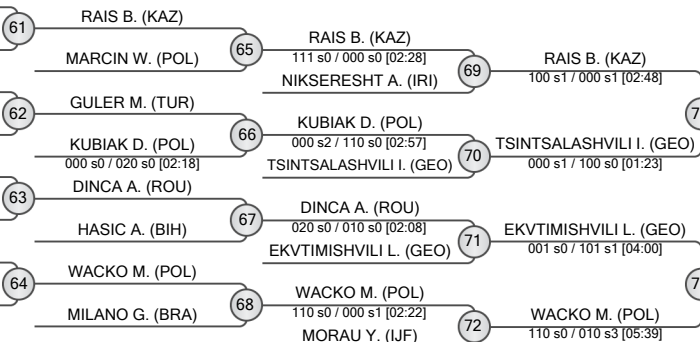



Istanbul Junior European Cup 2025

Türkiye, İstanbul, 3-4 May 2025

+100 kg

Men (24)

POOL A

COELHO Andrey	BRA	1	COELHO A. (BRA)
HATAKEYAMA Gai	JPN	2	HATAKEYAMA G. (JPN)
BADUASHVILI Giorgi	GEO		
GANTULGA Khangarid	MGL	3	GANTULGA K. (MGL)
AKCA Baris	TUR		
YADIGARLI Rauf	AZE	4	YADIGARLI R. (AZE)

POOL B

BIGANASHVILI Tamaz	GEO	5	BIGANASHVILI T. (GEO)
ZEGGAI Noaim	FRA	6	YERZHANULY S. (KAZ)
YERZHANULY Shynggys	KAZ		
RAFIKOV Fazliddin	UZB	7	RAFIKOV F. (UZB)
MADEN Mahmutcan	TUR	8	KOBALADZE N. (GEO)
KOBALADZE Nodar	GEO		

POOL C

DOS SANTOS Gabriel	BRA	9	DOS SANTOS G. (BRA)
POLAT Zubeyir Talha	TUR	10	BALLERING M. (NED)
BALLERING Martinus	NED		
ALPANOV Sherkhan	KAZ	11	ALPANOV S. (KAZ)
KHARAZISHVILI Daviti	GEO	12	KHARAZISHVILI D. (GEO)
MASKOU Mikita	IJF		

POOL D

AHMADOV Ramazan	AZE	13	AHMADOV R. (AZE)
TCHIKADZE Davit	GEO	14	TCHIKADZE D. (GEO)
TUTAR Tunahan	TUR		
ERGIN Recep	TUR	15	ERGIN R. (TUR)
TUGUI David	ROU	16	TUGUI D. (ROU)
ARMANULY Assanali	KAZ		

REPECHAGE

BADUASHVILI G. (GEO)	COELHO A. (BRA)	29	COELHO A. (BRA)
COELHO A. (BRA)	GANTULGA K. (MGL)	33	COELHO A. (BRA)
KOBALADZE N. (GEO)	BIGANASHVILI T. (GEO)	34	KOBALADZE N. (GEO)
BALLERING M. (NED)	ALPANOV S. (KAZ)	35	BALLERING M. (NED)
TUGUI D. (ROU)	AHMADOV R. (AZE)	36	AHMADOV R. (AZE)

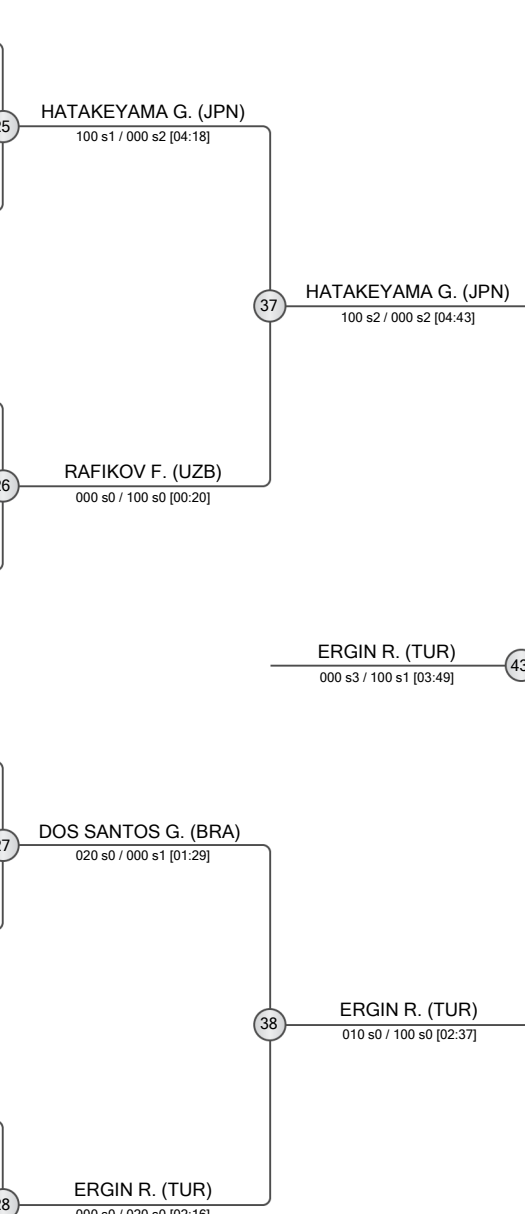

FINAL RESULTS

1.	ERGIN Recep	TUR	
2.	HATAKEYAMA Gai	JPN	
3.	DOS SANTOS Gabriel	BRA	
3.	AHMADOV Ramazan	AZE	
5.	KOBALADZE Nodar	GEO	
5.	RAFIKOV Fazliddin	UZB	
7.	COELHO Andrey	BRA	
7.	BALLERING Martinus	NED	





Istanbul Junior European Cup 2025

Türkiye, İstanbul, 3-4 May 2025

-48 kg

Women (26)

POOL A

	DIAZ HERNANDEZ Aitana	ESP	1	DIAZ HERNANDEZ A. (ESP)
	DURMAZ Sila	TUR	2	MERMET C. (FRA)
	MERMET Clara	FRA		000 s1 / 010 s0 [05:10]
	DOGRUYOL Begumnaz	TUR	3	DOGRUYOL B. (TUR)
	TOGTBAATAR Otgonjargal	MGL		100 s0 / 000 s3 [07:04]
	NAUKENOVA Aizat	KAZ	4	NAUKENOVA A. (KAZ)
	BASIC Ena	BIH		110 s0 / 000 s0 [01:52]

POOL B

	NUNES Mariana	BRA	5	NUNES M. (BRA)
	KIRT Elif	TUR	6	KIRT E. (TUR)
	MAKEYENKA Aryna	IJF		100 s1 / 000 s3 [08:14]
	ABDUALI Tasnim	KAZ	7	ABDUALI T. (KAZ)
	LIMA Imane	FRA	8	LIMA I. (FRA)
	TOPALSALIHOGU Eda Naz	TUR		010 s0 / 000 s1 [04:00]

POOL C

	BOGDAN Laura	ROU	9	BOGDAN L. (ROU)
	TUNC Merve	TUR	10	TUNC M. (TUR)
	MIRZAYEVA Farida	AZE		001 s0 / 000 s0 [04:29]
	RANGELOVA Sofia	BUL	11	RANGELOVA S. (BUL)
	ARGEMI Maria Antonia	BRA		002 s0 / 001 s0 [04:28]
	OMONOVA Saina	KAZ	12	ERDOGMUS S. (TUR)
	ERDOGMUS Sewal	TUR		000 s0 / 111 s0 [03:30]

POOL D

	ERTEM Zilan	TUR	13	ERTEM Z. (TUR)
	OTEPKALI Zere	KAZ	14	PUENTE LOPEZ A. (ESP)
	PUENTE LOPEZ Africa	ESP		000 s1 / 100 s0 [02:46]
	KATENDI NZUZI Fina Pamedie	FRA	15	KATENDI NZUZI F. (FRA)
	OZDAMAR Ahsen Zulal	TUR	16	ALISHEROVA R. (UZB)
	ALISHEROVA Rukhshona	UZB		000 s3 / 100 s2 [04:29]

REPECHAGE

DURMAZ S. (TUR)	29	DURMAZ S. (TUR)	33	DOGRUYOL B. (TUR)
DIAZ HERNANDEZ A. (ESP)		101 s1 / 000 s1 [02:22]		000 s1 / 100 s0 [02:41]
MAKEYENKA A. (IJF)		DOGRUYOL B. (TUR)		
NUNES M. (BRA)	30	NUNES M. (BRA)	34	ABDUALI T. (KAZ)
		000 s0 / 010 s1 [04:00]		000 s2 / 010 s2 [06:26]
		ABDUALI T. (KAZ)		
TUNC M. (TUR)	31	TUNC M. (TUR)	35	ERDOGMUS S. (TUR)
		ERDOGMUS S. (TUR)		010 s2 / 011 s0 [04:00]
PUENTE LOPEZ A. (ESP)	32	PUENTE LOPEZ A. (ESP)	40	KATENDI NZUZI F. (FRA)
		KATENDI NZUZI F. (FRA)		000 s0 / 101 s1 [02:56]
				000 s2 / 100 s1 [05:43]

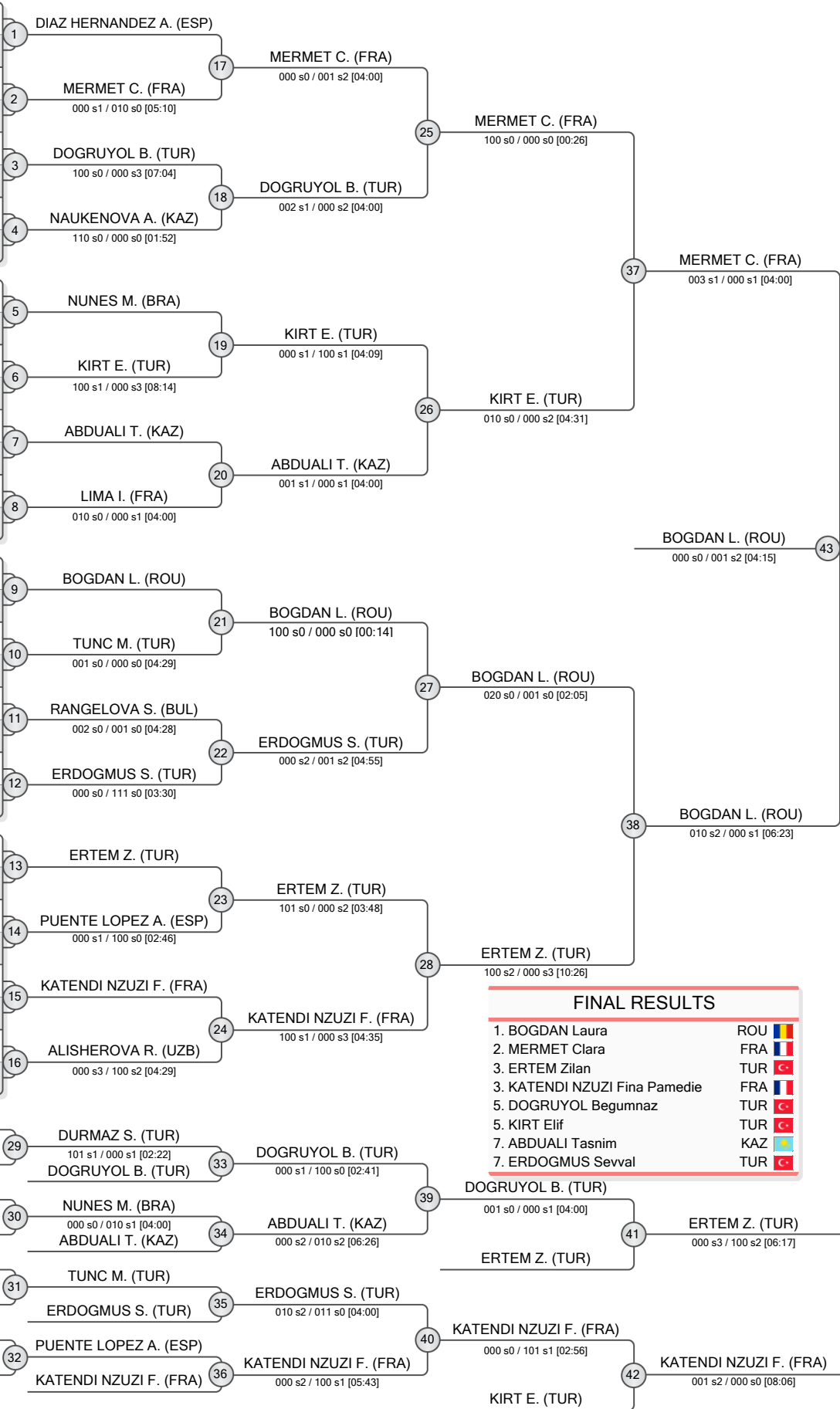

FINAL RESULTS

1.	BOGDAN Laura	ROU	
2.	MERMET Clara	FRA	
3.	ERTEM Zilan	TUR	
3.	KATENDI NZUZI Fina Pamedie	FRA	
5.	DOGRUYOL Begumnaz	TUR	
5.	KIRT Elif	TUR	
7.	ABDUALI Tasnim	KAZ	
7.	ERDOGMUS Sewal	TUR	





Istanbul Junior European Cup 2025

Türkiye, İstanbul, 3-4 May 2025

-52 kg

Women (25)

POOL A

	RODRIGUES Rafaela	BRA	1	RODRIGUES R. (BRA)
	MARQUES Alicia	FRA	2	MARQUES A. (FRA)
	KARASU Sura Nil	TUR		100 s1 / 000 s3 [04:17]
	JAMALOVA Zarina	UZB	3	BEORLEGUI OSES M. (ESP)
	BEORLEGUI OSES Marta	ESP		000 s1 / 001 s1 [05:31]
	LEISHANGTHEM Nungshithoi Chanu	IND	4	LEISHANGTHEM N. (IND)
	DEMIR Yagmurnisa	TUR		101 s0 / 001 s0 [02:43]

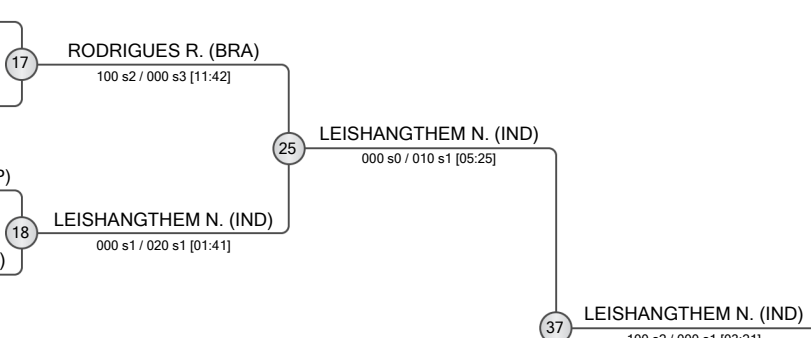

POOL B

	CATANA Luciana	ROU	5	CATANA L. (ROU)
	SARSENBEK Nurailym	KAZ	6	SARSENBEK N. (KAZ)
	DINCER Gizem	TUR		011 s2 / 000 s1 [04:00]
	GADASHOVA Khadzha	AZE	7	GADASHOVA K. (AZE)
	LUIS Shanice	NED	8	LUIS S. (NED)
	VISHNIAK Katsiaryna	IJF		011 s0 / 000 s0 [04:00]

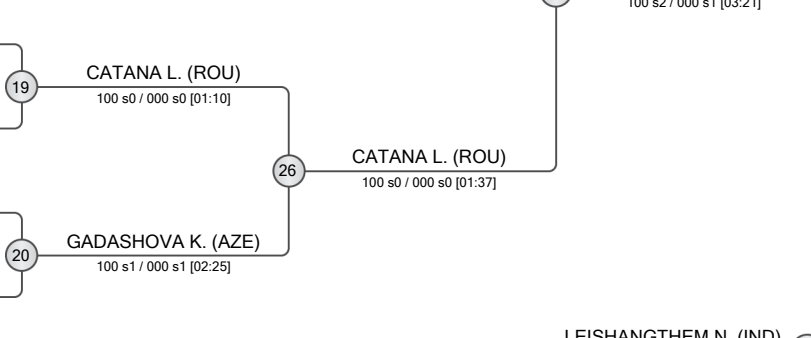

POOL C

	MARQUES Nicole	BRA	9	MARQUES N. (BRA)
	SARIKAYA Zeynep Betul	TUR	10	PECQUEUX M. (FRA)
	PECQUEUX Maia	FRA		000 s1 / 100 s0 [01:45]
	KAIRAT Ayaulym	KAZ	11	KAIRAT A. (KAZ)
	POMANA Silvia	ROU	12	GRIGORENKO D. (IJF)
	GRIGORENKO Diana	IJF		001 s0 / 110 s1 [03:35]

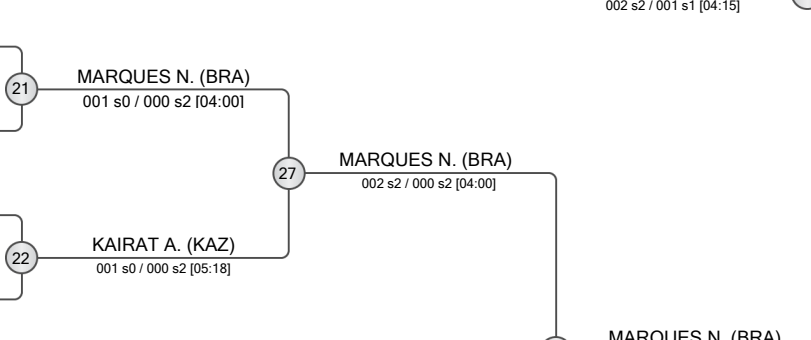

POOL D

	SANTIAGO SANTANA Odalis	ESP	13	SANTIAGO SANTANA O. (ESP)
	VAN LEEUWEN Emma	NED	14	VAN LEEUWEN E. (NED)
	YALCIN Elif Nur	TUR		100 s0 / 010 s0 [01:37]
	YILDIRIM Seyma	TUR	15	YILDIRIM S. (TUR)
	ZAINUL Nurbala	KAZ	16	ZAINUL N. (KAZ)
	SADIGOVA Chinara	AZE		001 s0 / 000 s1 [05:03]

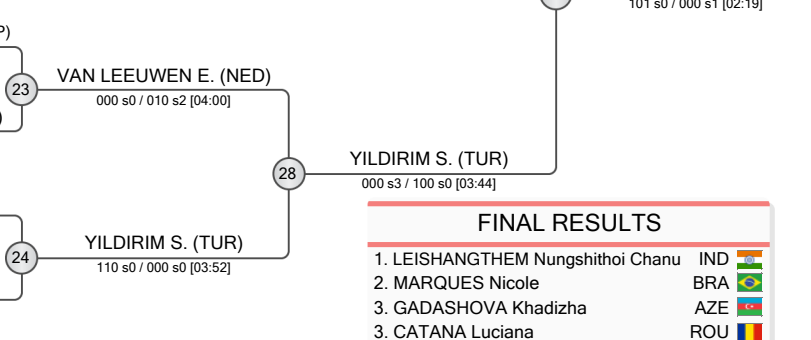

REPECHAGE

	DEMIR Y. (TUR)			BEORLEGUI OSES M. (ESP)
	BEORLEGUI OSES M. (ESP)	29		RODRIGUES R. (BRA)
				010 s0 / 100 s0 [03:30]
				RODRIGUES R. (BRA)
				000 s0 / 001 s0 [05:52]
				SARSENBEK N. (KAZ)
				GADASHOVA K. (AZE)
				000 s2 / 021 s0 [03:42]
				PECQUEUX M. (FRA)
				KAIRAT A. (KAZ)
				000 s0 / 010 s0 [04:00]
				ZAINUL N. (KAZ)
				VAN LEEUWEN E. (NED)
				000 s2 / 001 s2 [07:11]

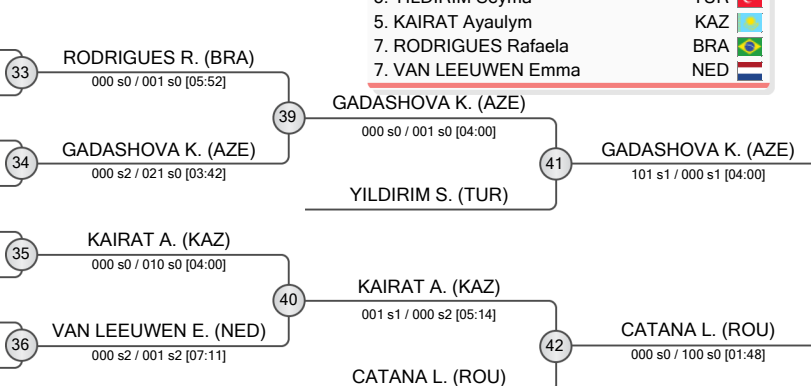

FINAL RESULTS

- LEISHANGTHEM Nungshithoi Chanu
- MARQUES Nicole
- GADASHOVA Khadzha
- CATANA Luciana
- YILDIRIM Seyma
- KAIRAT Ayaulym
- RODRIGUES Rafaela
- VAN LEEUWEN Emma





Istanbul Junior European Cup 2025

Türkiye, İstanbul, 3-4 May 2025

-57 kg

Women (31)

POOL A

	ANDRADE Gyovanna	BRA	1	ANDRADE G. (BRA)
	OZDEMIR Ayse Naz	TUR	2	OZDEMIR A. (TUR)
	ZHALINOVA Akbota	KAZ		001 s2 / 000 s2 [04:00]
	ALBITOS LOPEZ Carla	ESP	3	ALLABERGANOVA M. (UZB)
	ALLABERGANOVA Mohinur	UZB		000 s1 / 013 s1 [04:00]
	YILDIZ Nilda	TUR	4	VERDIYEVA A. (AZE)
	VERDIYEVA Aytan	AZE		000 s0 / 100 s0 [01:32]

POOL B

	GRAMATIKOVA Snezhana	BUL	5	GRAMATIKOVA S. (BUL)
	ZUEND Annika	SUI		100 s0 / 000 s0 [01:12]
	BUYUK Sena Nur	TUR	6	DROBOTA R. (ROU)
	DROBOTA Rebecca	ROU		000 s3 / 100 s0 [03:31]
	CARILLON Clarisse	FRA	7	AGAR E. (TUR)
	AGAR Elif	TUR		000 s0 / 100 s0 [00:00]
	NEDANOVSKA Liljana	MKD	8	BAYRAMOVA G. (AZE)
	BAYRAMOVA Gulnara	AZE		000 s0 / 100 s0 [00:19]

POOL C

	BIRRI Madeleine	GBR	9	BIRRI M. (GBR)
	BASARIR Ceylin	TUR		003 s0 / 001 s1 [04:00]
	KARAKENOVA Karina	KAZ	10	PROBST E. (SUI)
	PROBST Eileen	SUI		002 s2 / 100 s1 [03:54]
	KORKMAZ Gulzade	TUR	11	KORKMAZ G. (TUR)
	MOUSSATI Inaya	FRA		002 s1 / 000 s0 [04:00]
	ARALBAEVA Aselkhan	UZB	12	ARALBAEVA A. (UZB)
	KRAUS Daria	ROU		021 s0 / 000 s0 [02:25]

POOL D

	POLLHEIMER Mirja	SUI	13	POLLHEIMER M. (SUI)
	IDDIR Feroudja	FRA		111 s1 / 000 s0 [03:19]
	CEKICI Sumeyye	TUR	14	KSIONZHUK E. (IJF)
	KSIONZHUK Emiliya	IJF		000 s0 / 101 s0 [01:22]
	FRADE Victoria	BRA	15	FRADE V. (BRA)
	OZTURK Zeynep	TUR		100 s0 / 000 s3 [03:42]
	DUMA Carla	ROU	16	GASIMOVA F. (AZE)
	GASIMOVA Fidan	AZE		000 s1 / 002 s0 [04:00]

REPECHAGE

ALBITOS LOPEZ C. (ESP)	29	ALBITOS LOPEZ C. (ESP)	33	ANDRADE G. (BRA)
VERDIYEVA A. (AZE)		101 s0 / 000 s0 [03:01]		001 s1 / 000 s2 [05:24]
ZUEND A. (SUI)		ZUEND A. (SUI)	34	BAYRAMOVA G. (AZE)
DROBOTA R. (ROU)	30	100 s0 / 000 s0 [02:55]		111 s0 / 000 s1 [02:37]
KRAUS D. (ROU)		KORKMAZ G. (TUR)	31	BIRRI M. (GBR)
KORKMAZ G. (TUR)		000 s0 / 101 s0 [03:14]		000 s0 / 001 s1 [04:29]
IDDIR F. (FRA)		IDDIR F. (FRA)	32	IDDIR F. (FRA)
KSIONZHUK E. (IJF)		100 s1 / 000 s2 [04:50]		002 s2 / 001 s1 [04:15]
		GASIMOVA F. (AZE)	36	

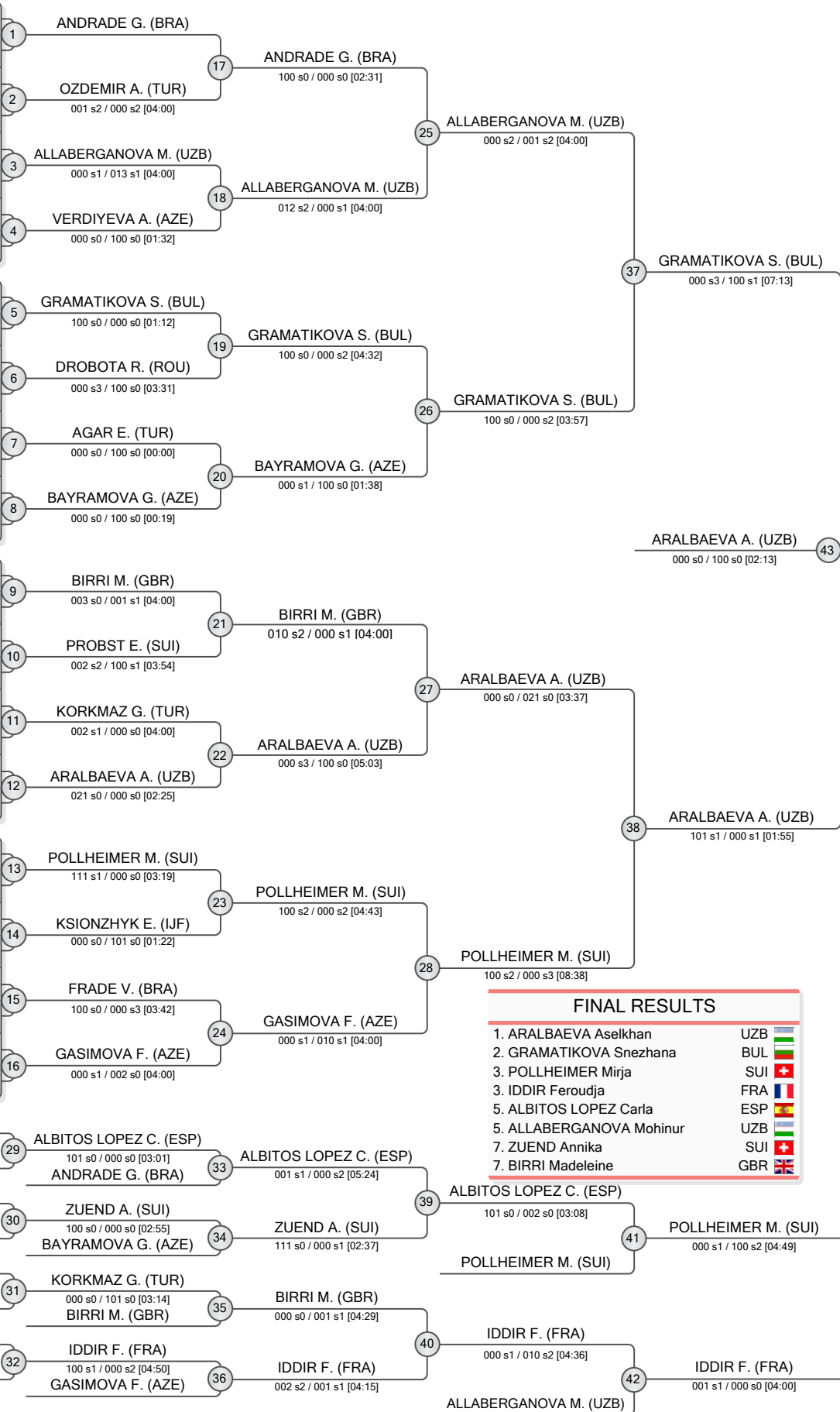

FINAL RESULTS

1.	ARALBAEVA Aselkhan	UZB	
2.	GRAMATIKOVA Snezhana	BUL	
3.	POLLHEIMER Mirja	SUI	
4.	IDDIR Feroudja	FRA	
5.	ALBITOS LOPEZ Carla	ESP	
6.	ALLABERGANOVA Mohinur	UZB	
7.	ZUEND Annika	SUI	
8.	BIRRI Madeleine	GBR	





Istanbul Junior European Cup 2025

Türkiye, İstanbul, 3-4 May 2025

-63 kg

Women (30)

POOL A

	BASTOS Eduarda	BRA	1
	BONITO Carla	FRA	2
	ALTUN Oyku	TUR	3
	HANGYI Eva	NED	4
	RZAYEVA Nilgun	AZE	5
	ASSYLKHANOVA Damelya	KAZ	6
	KOZLJAK Dzejla	BIH	7

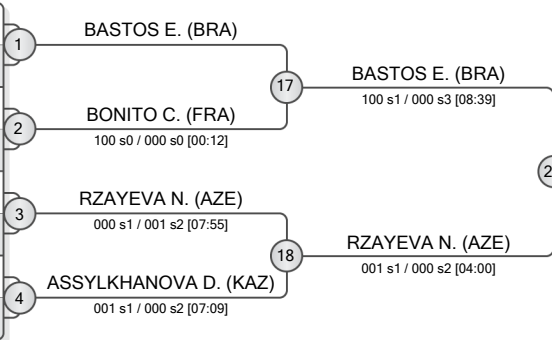

POOL B

	AGATI-ALOUACHE Manon	FRA	5
	AKYILDIZ Hilal	TUR	6
	LAIN-NAU Solene	SUI	7
	INOUE MACHADO Carolina Eiko	BRA	8
	XUSANOVA Sarvinoz	UZB	9
	UNGUREANU Bianca	ROU	10
	COMART Betul	TUR	11
	OMURZAKOVA Zhibek	KGZ	12

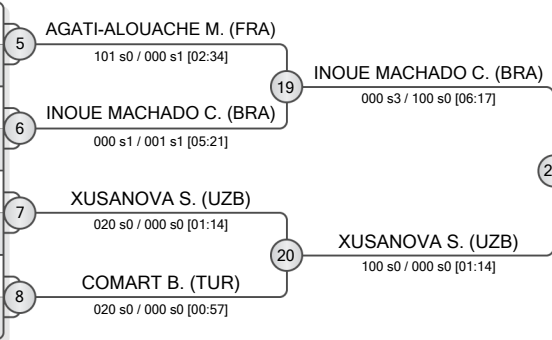

POOL C

	AVELINO Maria	BRA	9
	FIODARAVA Viyaleta	IJF	10
	KAKITAEVA Meerim	KGZ	11
	ORUC Sinem	TUR	12
	SARTO Brenda	BRA	13
	PHINERA Ines	FRA	14
	TELMAN Karlygash	KAZ	15

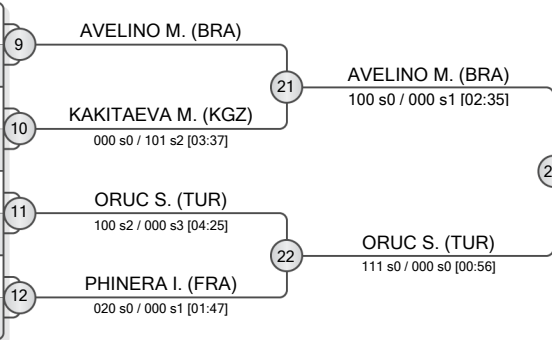

POOL D

	FEITOSA Ana Beatriz	BRA	13
	ABIKHANOVA Aidana	KAZ	14
	TOPCU Ceren	TUR	15
	ATAYEVA Leyla	AZE	16
	VATANSEVER Ceyda	TUR	17
	CHANAMBAM Linthoi	IND	18
	LAJOS Orsolya	ROU	19
	CHIPAN Jaelynn	FRA	20

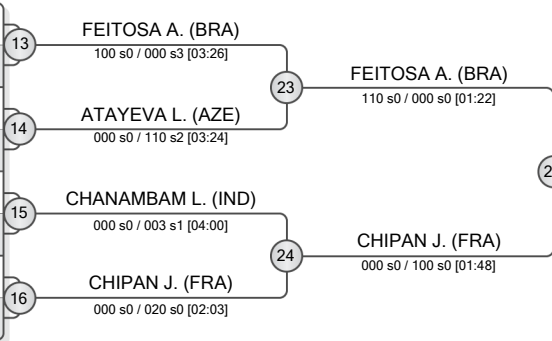

REPECHAGE

	BONITO C. (FRA)	29
	LAIN-NAU S. (SUI)	30
	SARTO B. (BRA)	31
	ABIKHANOVA A. (KAZ)	32
	BONITO C. (FRA)	33
	AGATI-ALOUACHE M. (FRA)	34
	PHINERA I. (FRA)	35
	ATAYEVA L. (AZE)	36

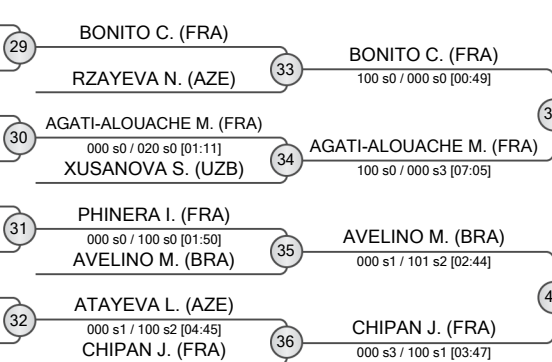

FINAL RESULTS		
1.	INOUE MACHADO Carolina Eiko	BRA
2.	FEITOSA Ana Beatriz	BRA
3.	ORUC Sinem	TUR
3.	CHIPAN Jaelynn	FRA
5.	AGATI-ALOUACHE Manon	FRA
5.	BASTOS Eduarda	BRA
7.	BONITO Carla	FRA
7.	AVELINO Maria	BRA

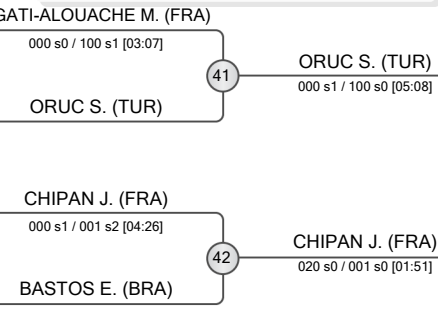



Istanbul Junior European Cup 2025

Türkiye, İstanbul, 3-4 May 2025

-70 kg

Women (20)

POOL A

	OLIVEIRA Maria Eduarda	BRA	1	OLIVEIRA M. (BRA)
	SCHILLINGS Chloe	LUX	2	SCHILLINGS C. (LUX)
	JAAFAR Nadie	BUL	3	JAAFAR N. (BUL)
	DE KOCK Luna	NED	4	BAYSUG E. (TUR)
	BAYSUG Ecem	TUR	4	BAYSUG E. (TUR)

POOL B

	KHAMROEVA Tuygul	UZB	5	KHAMROEVA T. (UZB)
	SUCIU Anamaria	ROU	6	SUCIU A. (ROU)
	MOLDOKULOVA Alina	KGZ	7	MOLDOKULOVA A. (KGZ)
	BITIMBAY Shynar	KAZ	8	BITIMBAY S. (KAZ)
	ABDULLAYEVA Parvana	AZE	8	BITIMBAY S. (KAZ)

POOL C

	ADIL Sagira	KAZ	9	ADIL S. (KAZ)
	KOCYIGIT Hatice	TUR	10	SALA CANO A. (ESP)
	SALA CANO Aitana	ESP	10	SALA CANO A. (ESP)
	SITNIK Hanna	IJF	11	SITNIK H. (IJF)
	USURELU Alexia	ROU	12	USURELU A. (ROU)

POOL D

	MARCON Carolina	BRA	13	MARCON C. (BRA)
	ZONGUR Ayse	TUR	14	ZONGUR A. (TUR)
	DEPRI Ilona	FRA	15	DEPRI I. (FRA)
	MICIC Una	BIH	16	MICIC U. (BIH)
	BOGDAN Smaranda	ROU	16	MICIC U. (BIH)

REPECHAGE

SCHILLINGS C. (LUX)	29	SCHILLINGS C. (LUX)	BAYSUG E. (TUR)	33
SUCIU A. (ROU)	30	SUCIU A. (ROU)	MOLDOKULOVA A. (KGZ)	34
USURELU A. (ROU)	31	USURELU A. (ROU)	SALA CANO A. (ESP)	35
ZONGUR A. (TUR)	32	ZONGUR A. (TUR)	DEPRI I. (FRA)	36

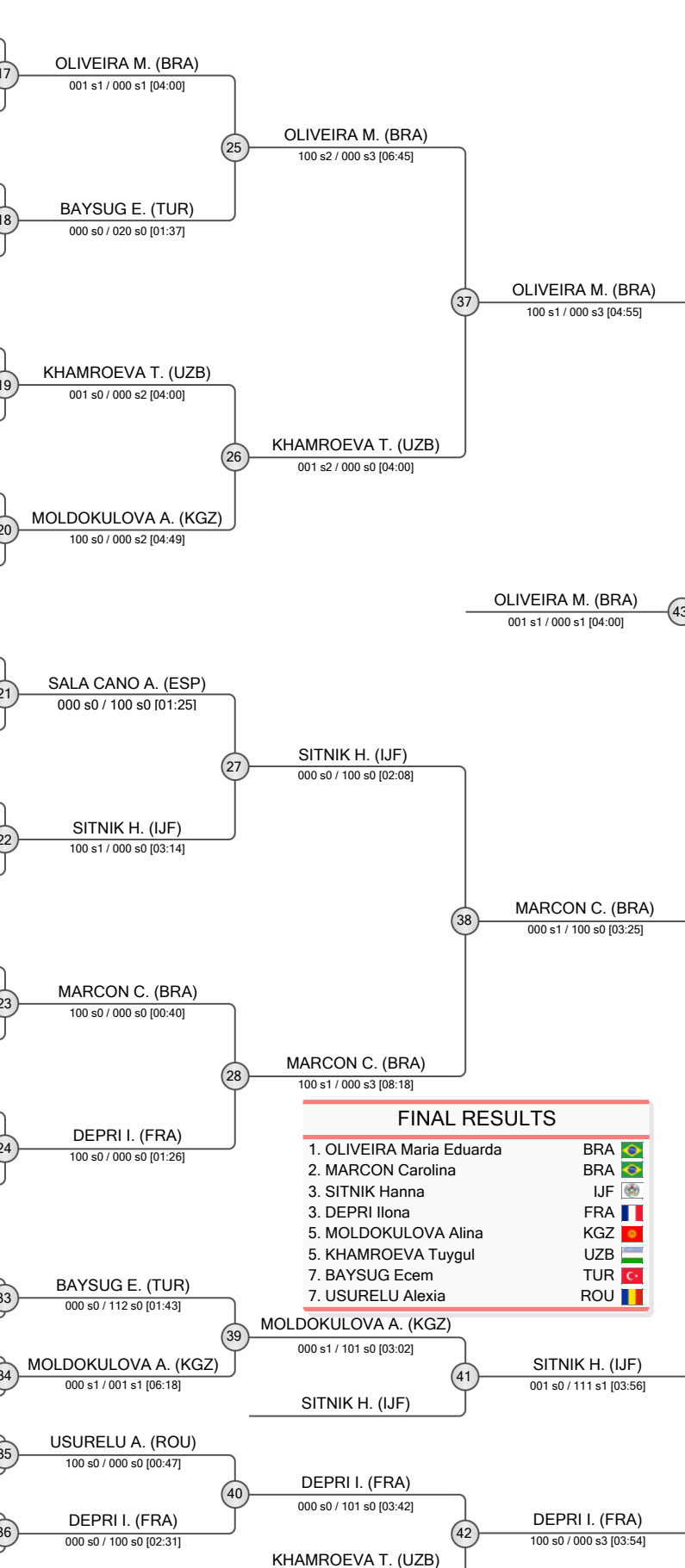

FINAL RESULTS

1.	OLIVEIRA Maria Eduarda	BRA	
2.	MARCON Carolina	BRA	
3.	SITNIK Hanna	IJF	
3.	DEPRI Ilona	FRA	
5.	MOLDOKULOVA Alina	KGZ	
5.	KHAMROEVA Tuygul	UZB	
7.	BAYSUG Ecem	TUR	
7.	USURELU Alexia	ROU	





Istanbul Junior European Cup 2025

Türkiye, İstanbul, 3-4 May 2025

-78 kg

Women (16)

POOL A

	CAMILO Dandara	BRA
	KEMELKHANKYZY Nurshat	KAZ
	YAHSI Ela Naz	TUR
	TURDAZHIEVA Akmarzhan	KGZ

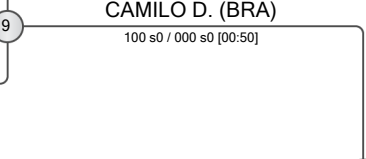
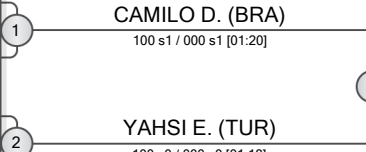

POOL B

	WOOD Nicole	GBR
	MAUD Romane	FRA
	RYLKEVICH Slaviana	IJF
	OMAROVA Bakytkul	KAZ

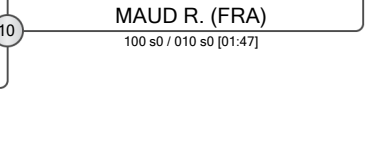
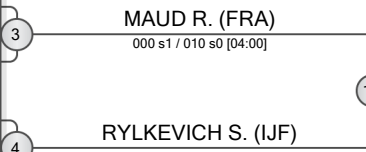

POOL C

	PAJIC Sofija	BIH
	CLOTEAUX Manon	FRA
	DILBIRLIGI Kevser	TUR
	MAHMUDJONOVA Sevinch	UZB

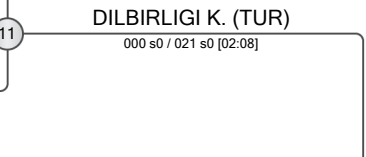
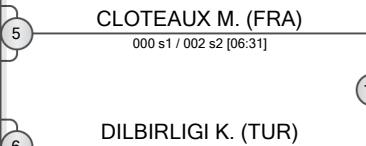

POOL D

	MORENO CAMPO June	ESP
	KOCABEY Ceylan	TUR
	AKHMETOVA Saltanat	KAZ
	HARTMEIJER Lindey	NED

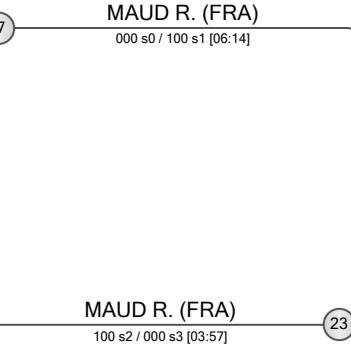
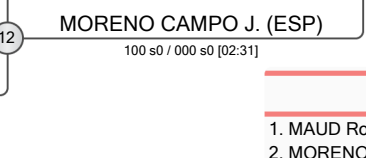
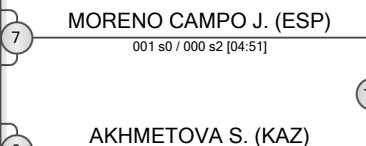

REPECHAGE

KEMELKHANKYZY N. (KAZ)	13	KEMELKHANKYZY N. (KAZ) 100 s0 / 000 s1 [01:41]
YAHSI E. (TUR)		
WOOD N. (GBR)	14	WOOD N. (GBR) 100 s0 / 000 s0 [01:54]
RYLKEVICH S. (IJF)		
MAHMUDJONOVA S. (UZB)	15	CLOTEAUX M. (FRA) 100 s0 / 000 s0 [01:54]
CLOTEAUX M. (FRA)		
KOCABEY C. (TUR)	16	KOCABEY C. (TUR) 100 s0 / 000 s0 [01:54]
AKHMETOVA S. (KAZ)		

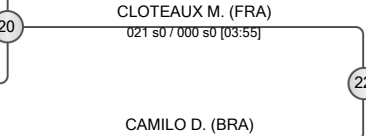
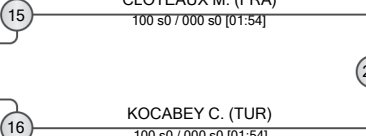
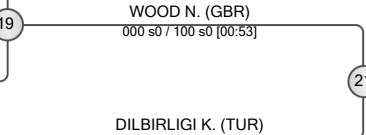
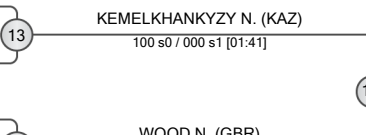

FINAL RESULTS		
1.	MAUD Romane	FRA
2.	MORENO CAMPO June	ESP
3.	WOOD Nicole	GBR
3.	CAMILO Dandara	BRA
5.	DILBIRLIGI Kevser	TUR
5.	CLOTEAUX Manon	FRA
7.	KEMELKHANKYZY Nurshat	KAZ
7.	KOCABEY Ceylan	TUR





Istanbul Junior European Cup 2025

Türkiye, İstanbul, 3-4 May 2025

+78 kg

Women (16)

POOL A

	DAS CHAGAS PEREIRA Evellyn Vitoria	BRA
	GOL Efsa Ceylin	TUR
	SULEYMANOVA Nigar	AZE
	GUCTEKIN Irmak Ceylin	TUR

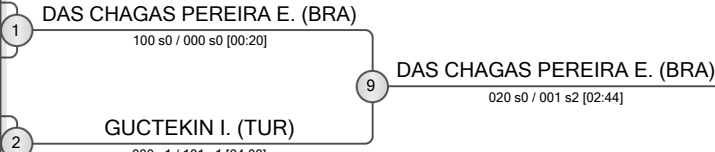

POOL B

	SOARES Ana	BRA
	NIGMATOVA Umida	UZB
	TUDORACHE Daria	ROU
	COSKUN Gizem	TUR

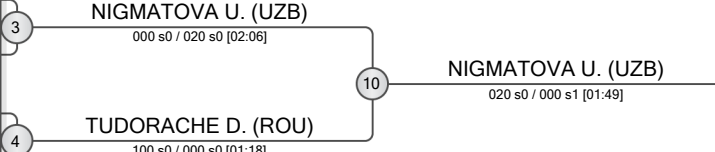

POOL C

	TUKHTAMISHEVA Mokhlaroyim	UZB
	ARDIC Hayrun Nisa	TUR
	METE Sema	TUR
	BAKYTBEK Korkem	KAZ

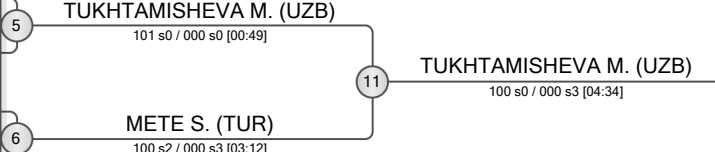

POOL D

	YILMAZ Yagmur	TUR
	VISA Roxana	ROU
	LANG Bintibe	FRA
	DUMANKYZY Aiyhzada	KAZ

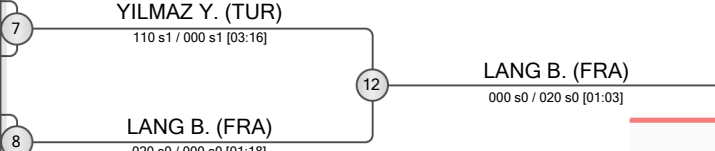

REPECHAGE

GOL E. (TUR)	13	GUCTEKIN I. (TUR) 000 s2 / 100 s2 [01:18]
GUCTEKIN I. (TUR)		
SOARES A. (BRA)	14	SOARES A. (BRA) 100 s0 / 000 s3 [02:34]
TUDORACHE D. (ROU)		
ARDIC H. (TUR)	15	METE S. (TUR) 100 s0 / 000 s3 [02:34]
METE S. (TUR)		
DUMANKYZY A. (KAZ)	16	DUMANKYZY A. (KAZ) 100 s0 / 000 s3 [02:34]
YILMAZ Y. (TUR)		

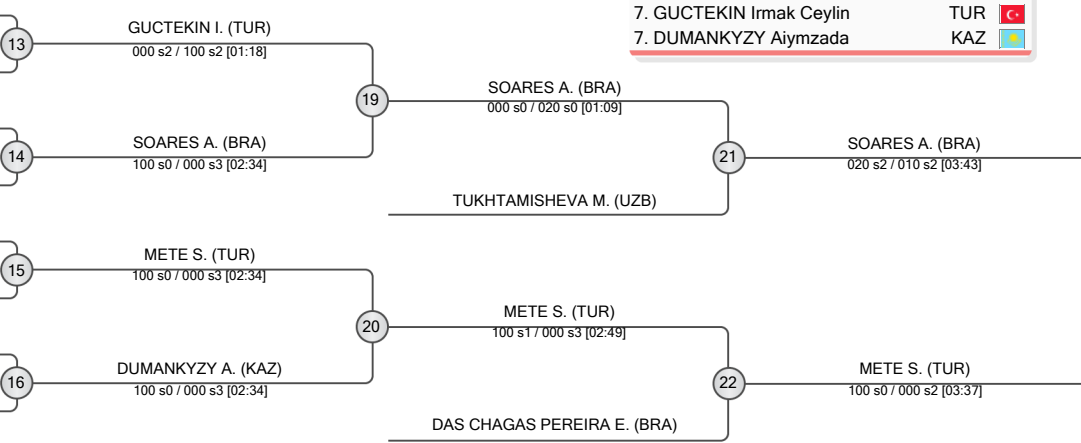

FINAL RESULTS

1.	NIGMATOVA Umida	UZB	
2.	LANG Bintibe	FRA	
3.	SOARES Ana	BRA	
3.	METE Sema	TUR	
5.	TUKHTAMISHEVA Mokhlaroyim	UZB	
5.	DAS CHAGAS PEREIRA Evellyn Vitoria	BRA	
7.	GUCTEKIN Irmak Ceylin	TUR	
7.	DUMANKYZY Aiyhzada	KAZ	

