



Prague Junior European Cup 2026

Czechia, Prague, 4-5 Jul 2026

-60 kg

Juniors (41)

POOL A

USA	1	YANG J. (USA)
AZE	2	MIRZAZADA A. (AZE)
BUL	3	JAKL M. (CZE)
ITA	4	KIRIELEISON F. (ITA)
UKR	5	AVRAMENKO D. (UKR)
ITA	6	DOSBERGEN N. (KAZ)
KAZ	7	CRUZ G. (BRA)
GER	8	BERGER A. (GER)

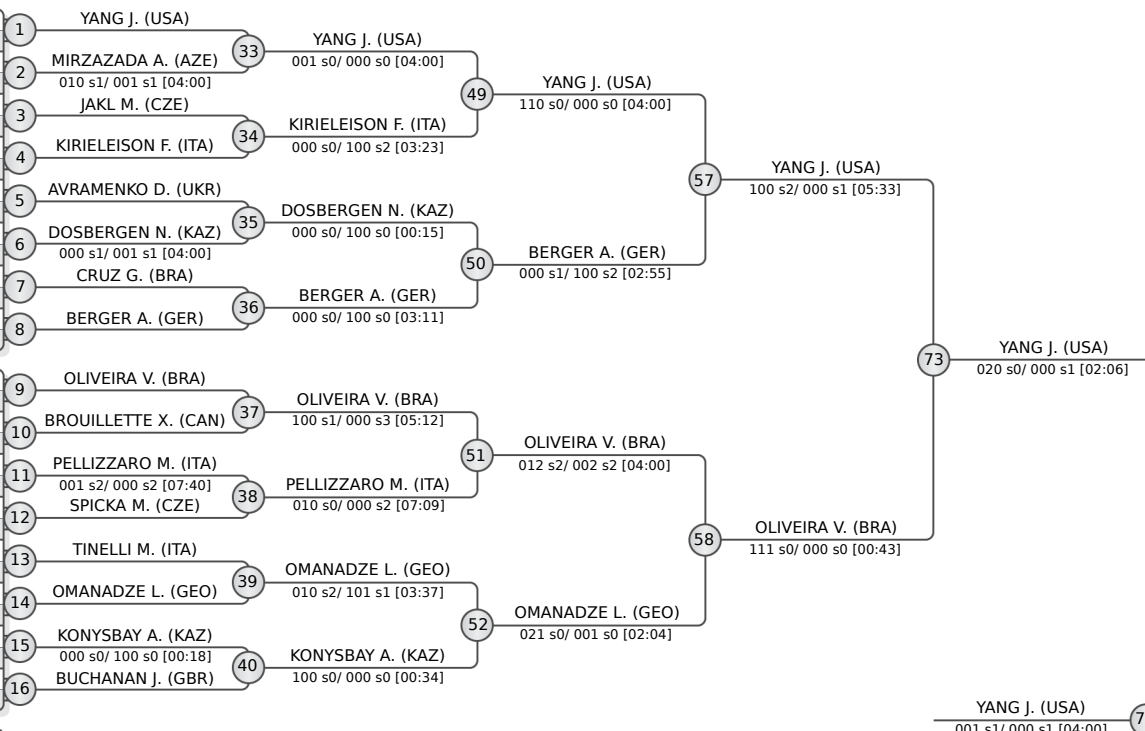

POOL B

BRA	9	OLIVEIRA V. (BRA)
CAN	10	BROUILLETTE X. (CAN)
ITA	11	PELLIZZARO M. (ITA)
KOR	12	SPICKA M. (CZE)
ITA	13	TINELLI M. (ITA)
GEO	14	OMANADZE L. (GEO)
FRA	15	KONYSBAY A. (KAZ)
KAZ	16	BUCHANAN J. (GBR)

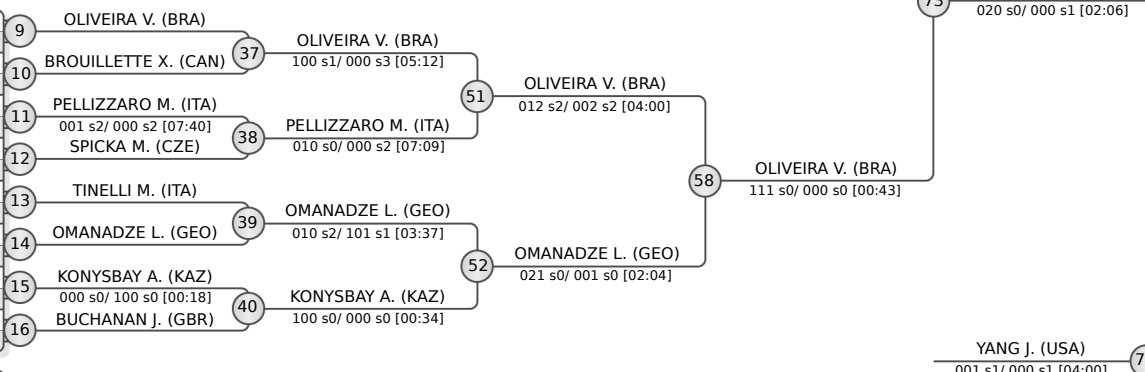

POOL C

AUS	17	LEE C. (AUS)
LTU	18	REIS A. (POR)
POR	19	SILVA V. (BRA)
ITA	20	GHEORGHIU D. (GBR)
KAZ	21	ZHENGISSULY K. (KAZ)
ITA	22	CAVALI S. (CZE)
CZE	23	KALIASHVILI L. (GEO)
ITA	24	SASSI T. (ITA)

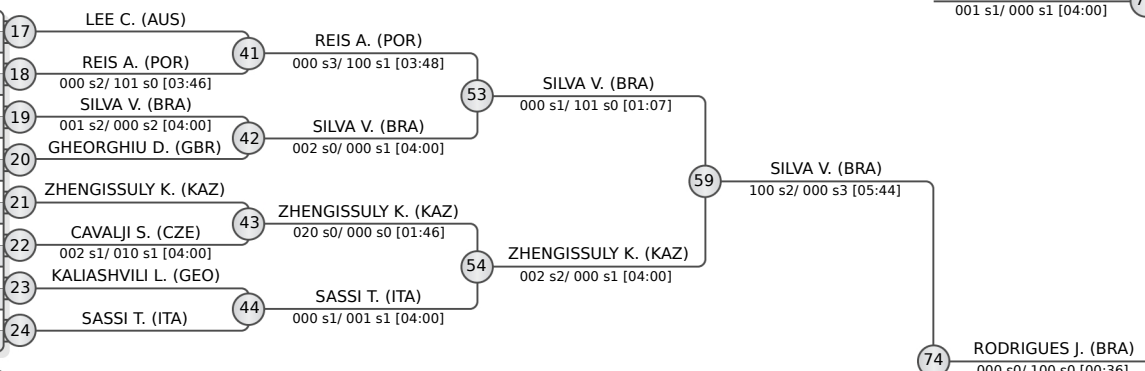

POOL D

ITA	25	CROCIANI F. (ITA)
SUI	26	CORI S. (SUI)
KAZ	27	ABDIMANAP A. (KAZ)
CAN	28	TONO T. (USA)
GEO	29	BACHOSHVILI S. (GEO)
BRA	30	RODRIGUES J. (BRA)
GRE	31	CHIARELLA L. (ITA)
ITA	32	BILKA O. (SVK)

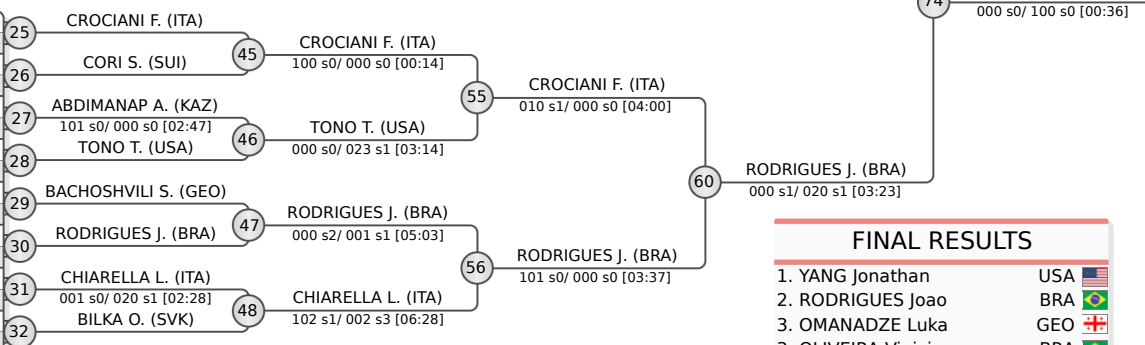

FINAL RESULTS		
1.	YANG Jonathan	USA
2.	RODRIGUES Joao	BRA
3.	OMANADZE Luka	GEO
3.	OLIVEIRA Vinicius	BRA
5.	SILVA Victor Hugo	BRA
5.	ZHENGISSULY Kairat	KAZ
7.	BERGER Arthur	GER
7.	CROCIANI Francesco	ITA

REPECHAGE

61	MIRZAZADA A. (AZE)
62	BROUILLETTE X. (CAN)
63	GHEORGHIU D. (GBR)
64	BACHOSHVILI S. (GEO)

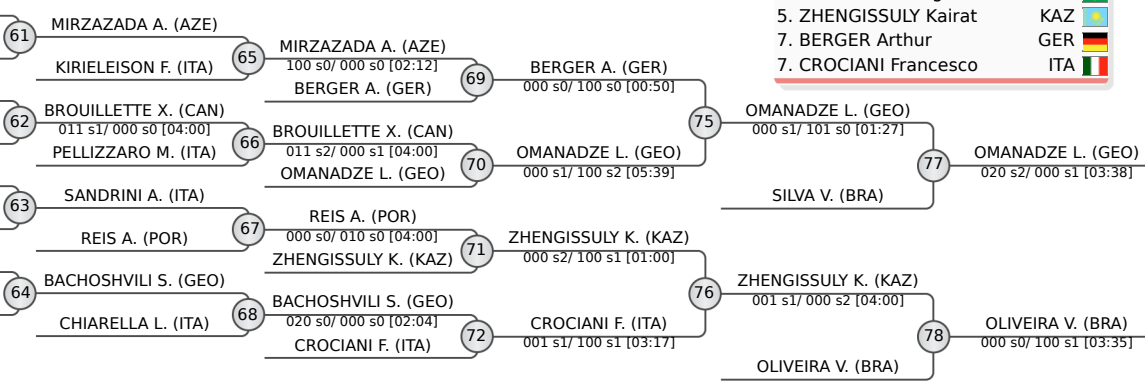



Prague Junior European Cup 2026

Czechia, Prague, 4-5 Jul 2026

-66 kg

Juniors (41)

POOL A

MUSAYEV Mahammad	AZE	1	MUSAYEV M. (AZE)
TERTULIANO Gustavo	BRA	2	TERTULIANO G. (BRA)
FIGUEIREDO Manuel	POR	3	FIGUEIREDO M. (POR)
JACKEVICIUS Rokas	LTU	4	JACKEVICIUS R. (LTU)
ESPOSITO Antonio	ITA	5	ESPOSITO A. (ITA)
ABYL Dias	KAZ	6	ABYL D. (KAZ)
SABASHVILI Saba	GEO	7	SABASHVILI S. (GEO)
MILJIC Srdjan	SRB	8	MILJIC S. (SRB)
DISCOLO Davide	ITA	9	DISCOLO D. (ITA)
OSTAPENKO Bohdan	UKR	10	OSTAPENKO B. (UKR)

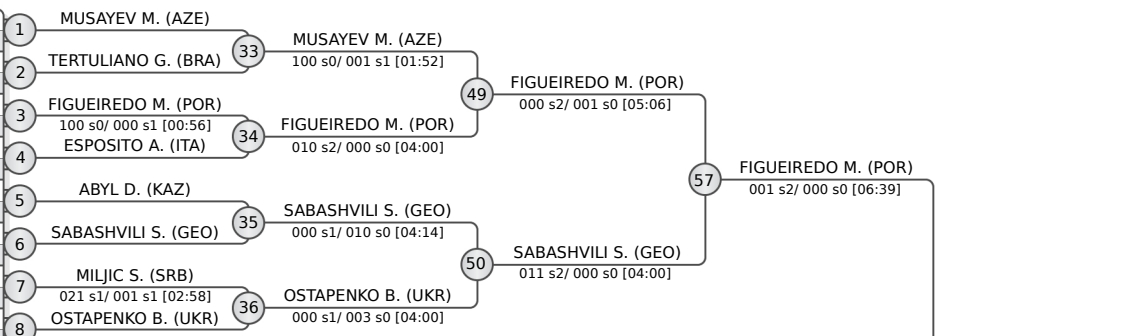

POOL B

MARTYNCHUK Oleksandr	UKR	9	MARTYNCHUK O. (UKR)
GHIDONI Thomas	ITA	10	GHIDONI T. (ITA)
COHEN Adrian	USA	11	COHEN A. (USA)
MIVOVAN Adrian	FRA	12	MIVOVAN A. (FRA)
ROZGA Roko	CRO	13	ROZGA R. (CRO)
BICORNGNI Alessandro	ITA	14	BICORNGNI A. (ITA)
LE DUC Tri	CZE	15	LE DUC T. (CZE)
BELIK Vadim	LTU	16	BELIK V. (LTU)
WINTER Felix	GER	17	WINTER F. (GER)
NEYOLOV Denis	CAN	18	NEYOLOV D. (CAN)
COHEN Itay	ISR	19	COHEN I. (ISR)

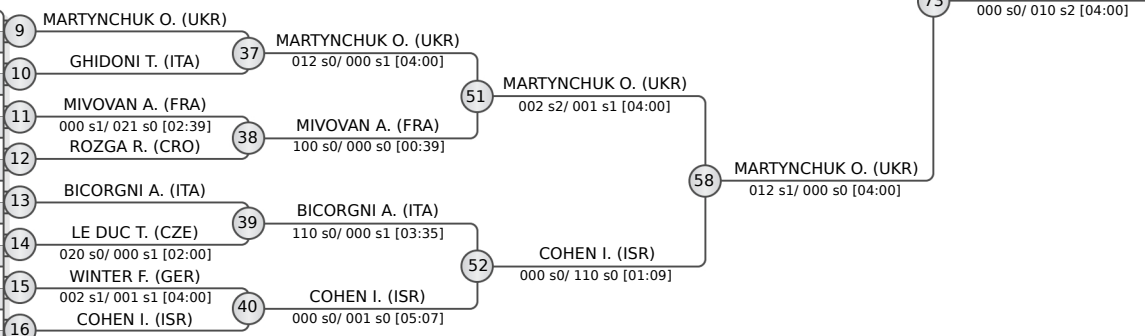

POOL C

CORMACK Angus	AUS	17	CORMACK A. (AUS)
PIO Leonardo	ITA	18	PIO L. (ITA)
JAKUBAUSKAS Adris	LTU	19	JAKUBAUSKAS A. (LTU)
DVORAK Petr	CZE	20	DVORAK P. (CZE)
SCHIER Francisco	BRA	21	SCHIER F. (BRA)
MIDDLETON Vas	AUS	22	MIDDLETON V. (AUS)
NIKOLOV Preslav	BUL	23	NIKOLOV P. (BUL)
LEE Jaejun	KOR	24	LEE J. (KOR)
BREKKE-JENSSEN Torstein	NOR	25	BREKKE-JENSSEN T. (NOR)
LEHMEN Theodore	USA	26	LEHMEN T. (USA)

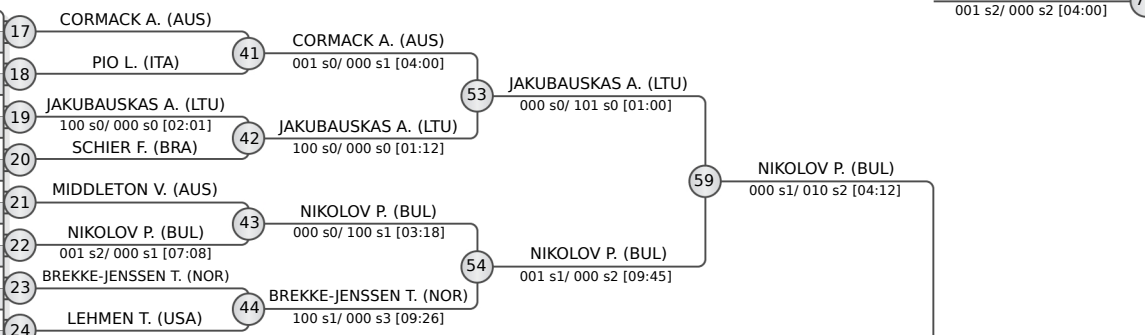

POOL D

POLIKEVICIUS Simas	LTU	25	POLIKEVICIUS S. (LTU)
PALILLO Thomas	ITA	26	PALILLO T. (ITA)
ECHAVARRIA Omar	USA	27	ECHAVARRIA O. (USA)
SIMSEK Mustafa Berat	TUR	28	SIMSEK M. (TUR)
DEKAN Roman	SVK	29	DEKAN R. (SVK)
MATI Anes	CAN	30	MATI A. (CAN)
ERCOLI Alessandro	ITA	31	ERCOLI A. (ITA)
BIELAN Aristarkh	UKR	32	BIELAN A. (UKR)
BAUD Romain	SUI	33	BAUD R. (SUI)
TAKHAEV Mukhamed	GER	34	TAKHAEV M. (GER)

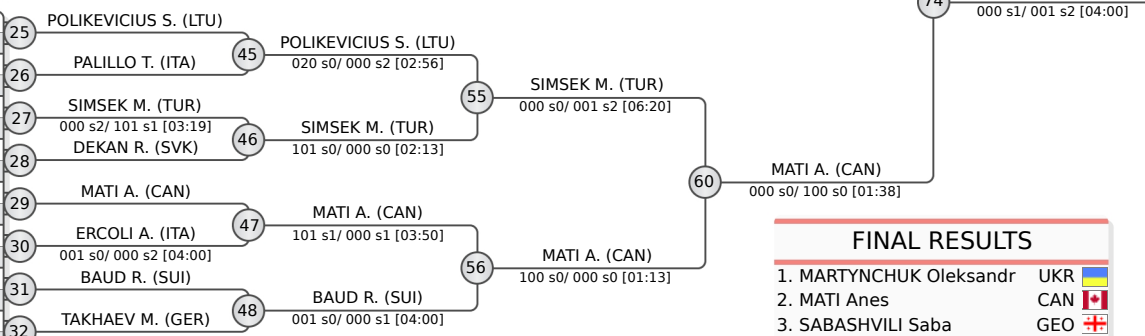

FINAL RESULTS		
1.	MARTYNCHUK Oleksandr	UKR
2.	MATI Anes	CAN
3.	SABASHVILI Saba	GEO
3.	SIMSEK Mustafa Berat	TUR
5.	NIKOLOV Preslav	BUL
5.	FIGUEIREDO Manuel	POR
7.	MIVOVAN Adrian	FRA
7.	JAKUBAUSKAS Adris	LTU

REPECHAGE

JACKEVICIUS R. (LTU)	61	ESPOSITO A. (ITA)	62	GHIDONI T. (ITA)	63	LEE J. (KOR)	64	ERCOLI A. (ITA)
ESPOSITO A. (ITA)	65	MUSAYEV M. (AZE)	66	MIVOVAN A. (FRA)	67	BREKKE-JENSSEN T. (NOR)	68	BAUD R. (SUI)
GHIDONI T. (ITA)	69	SABASHVILI S. (GEO)	70	COHEN I. (ISR)	71	JAKUBAUSKAS A. (LTU)	72	SIMSEK M. (TUR)
LEE J. (KOR)	73	MARTYNCHUK O. (UKR)	74	NIKOLOV P. (BUL)	75	SABASHVILI S. (GEO)	76	FIGUEIREDO M. (POR)
MIDDLETON V. (AUS)	77	SABASHVILI S. (GEO)	78	SIMSEK M. (TUR)	79	SIMSEK M. (TUR)		
ERCOLI A. (ITA)								

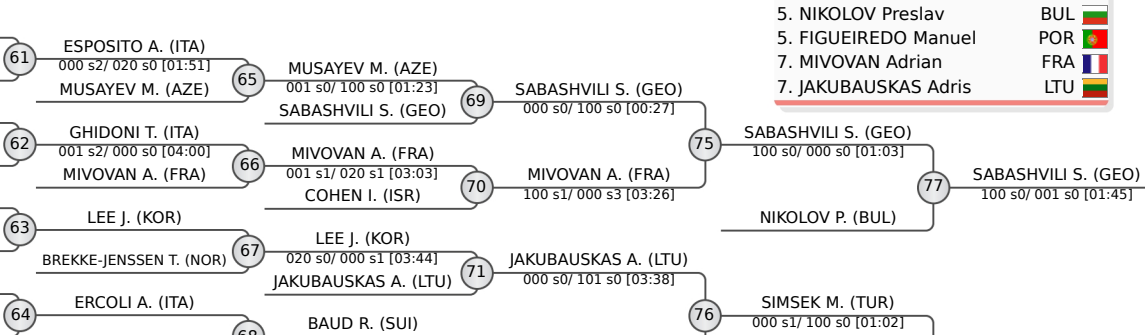



Prague Junior European Cup 2026

Czechia, Prague, 4-5 Jul 2026

-73 kg

Juniors (60)

POOL A

1	DOBRIČ Nikola (AUS)	2	PICCOLO G. (ITA)
3	MARYNYCH R. (UKR)	4	MOURA J. (BRA)
5	MAITIN S. (SUI)	6	PAVLOV P. (BUL)
7	BALESTRI E. (ITA)	8	RACKA N. (LTU)

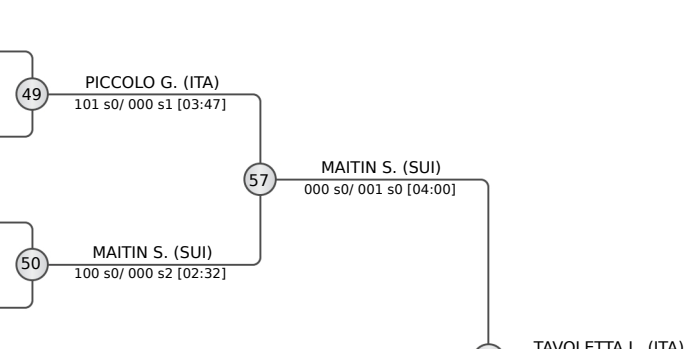

POOL B

9	TAVOLETTA L. (ITA)	10	BULUK Y. (TUR)
11	KENZHALIYEV T. (KAZ)	12	SULTANOV S. (AZE)
13	TERNULLO D. (USA)	14	DI LORENZO M. (ITA)
15	GIVISHVILI G. (GEO)	16	TSAPARAS K. (GRE)

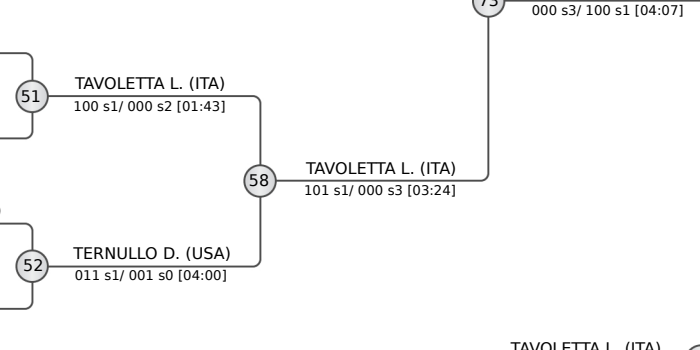

POOL C

17	FITHANE F. (CAN)	18	BASTOS H. (BRA)
19	JOVSA D. (LTU)	20	JAFAROV M. (AZE)
21	ISKAKOV N. (KAZ)	22	KABRAN K. (FRA)
23	MELO V. (POR)	24	GANGL C. (AUT)

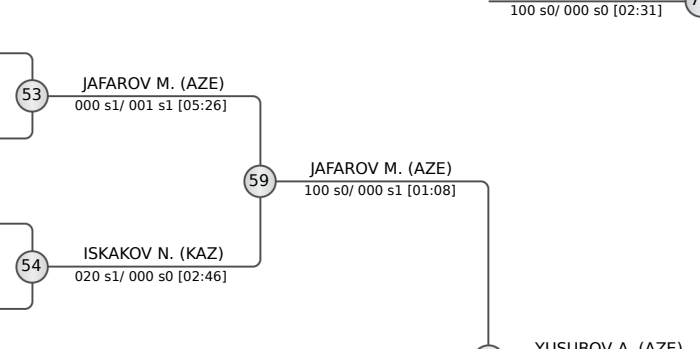

POOL D

25	BELL J. (AUS)	26	MIJIC M. (AUT)
27	DIMITROV I. (BUL)	28	PIDKIPNYY G. (UKR)
29	YUSUBOV A. (AZE)	30	KIM Y. (KOR)
31	RAKHIMZHANOV A. (KAZ)	32	TURGUTLU O. (TUR)

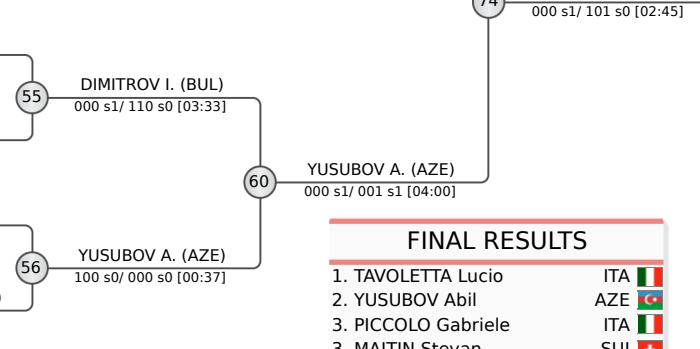

FINAL RESULTS

- TAVOLETTA Lucio (ITA)
- YUSUBOV Abil (AZE)
- PICCOLO Gabriele (ITA)
- MAITIN Stevan (SUI)
- JAFAROV Mehdi (AZE)
- ISKAKOV Nursultan (KAZ)
- BULUK Yusuf (TUR)
- DIMITROV Ivo (BUL)

REPECHAGE

61	PAVLOV P. (BUL)	62	BULUK Y. (TUR)
63	PRYSHCHEPA A. (UKR)	64	KIM Y. (KOR)
65	BALESTRI E. (ITA)	66	BULUK Y. (TUR)
67	FITHANE F. (CAN)	68	TURGUTLU O. (TUR)

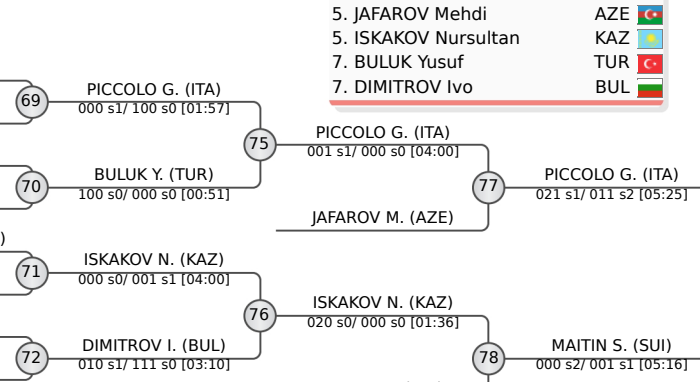



Prague Junior European Cup 2026

Czechia, Prague, 4-5 Jul 2026

-81 kg

Juniors (54)

POOL A

1	NEYOLOV Artem (CAN)	CAN
2	ZALAGH Redouane (FRA)	FRA
3	ZITA Ondrej (CZE)	CZE
4	MOCERINO Andrea (ITA)	ITA
5	SIMUNIC Fran (CRO)	CRO
6	SCHUMACHER Till (GER)	GER
7	RICHNER Suleyman (SUI)	SUI
8	JAKHVELADZE Saba (GEO)	GEO
9	VLACH Marek (CZE)	CZE
10	DAVIES Peter (GBR)	GBR
11	MANGIAPIA Daniel (ITA)	ITA
12	PURPIS Nikass (LAT)	LAT
13	KYDYRBAY Myrzatay (KAZ)	KAZ

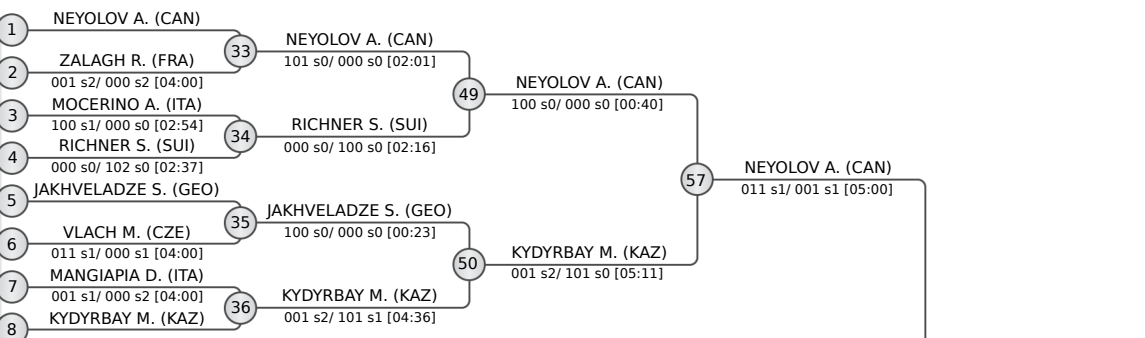

POOL B

9	SHULGIN Daniel (USA)	USA
10	VALCHEV Emil (BUL)	BUL
11	NAPSO Aslan (ISR)	ISR
12	TYBURN Elliott (FRA)	FRA
13	VAVRA Matyas (CZE)	CZE
14	DJURISIC Balsa (MNE)	MNE
15	ABBASOV Mehdi (AZE)	AZE
16	DE OLIVEIRA Octavio (USA)	USA
17	VAKHTANGADZE Tornike (GEO)	GEO
18	BRUECKNER Hannes (GER)	GER
19	HAJNECKY Marco (SVK)	SVK
20	ZADNIPRIANETS Ivan (UKR)	UKR
21	JICINSKY Radim (CZE)	CZE
22	D URBANO Alessandro Bruno (ITA)	ITA

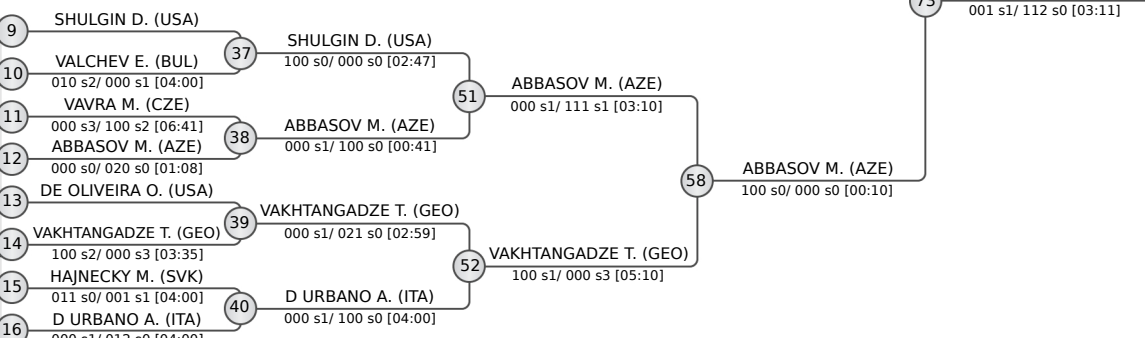

POOL C

17	JOHNSTON Kyle (AUS)	AUS
18	ZAK Adam (CZE)	CZE
19	GUDEJEVS Arsenijs (LAT)	LAT
20	MIHALEV Nikolaz (BUL)	BUL
21	HAMDAOUI Ahmed-Adam (FRA)	FRA
22	ROEDER Henry (GER)	GER
23	KUNDUKHASHVILI Shota (USA)	USA
24	NURBERGENOV Omar (KAZ)	KAZ
25	IBADLI Jasur (AZE)	AZE
26	IOANNOU Markelos (CYP)	CYP
27	SARBOCH Adam (CZE)	CZE
28	ISDAHL Thomas Eriksen (NOR)	NOR
29	RUSSO Edoardo Michele (ITA)	ITA

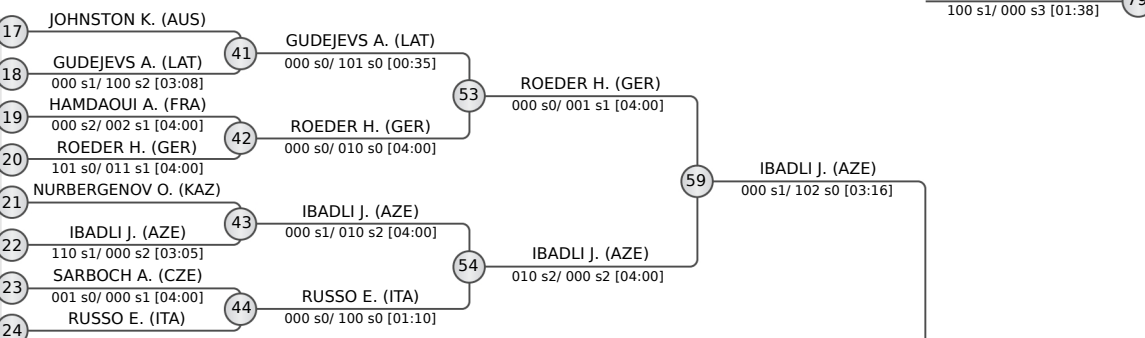

POOL D

25	COSTA Silas (BRA)	BRA
26	KIBIZOV Sarmat (CAN)	CAN
27	GARAYEV Roman (AZE)	AZE
28	GRABNER Erik (AUT)	AUT
29	CIGNINI Luca (ITA)	ITA
30	HAVRANEK Josip (CRO)	CRO
31	MILLER Evan (USA)	USA
32	NIELZIEV Taras (UKR)	UKR
33	RAK Maxmilian (CZE)	CZE
34	KOCZINSKI Arel (ISR)	ISR
35	SIMIN Milan (SRB)	SRB
36	KURDGELASHVILI Nikoloz (GEO)	GEO
37	BULATOVIC Filip (MNE)	MNE
38	MAZZOLA Salvatore (ITA)	ITA

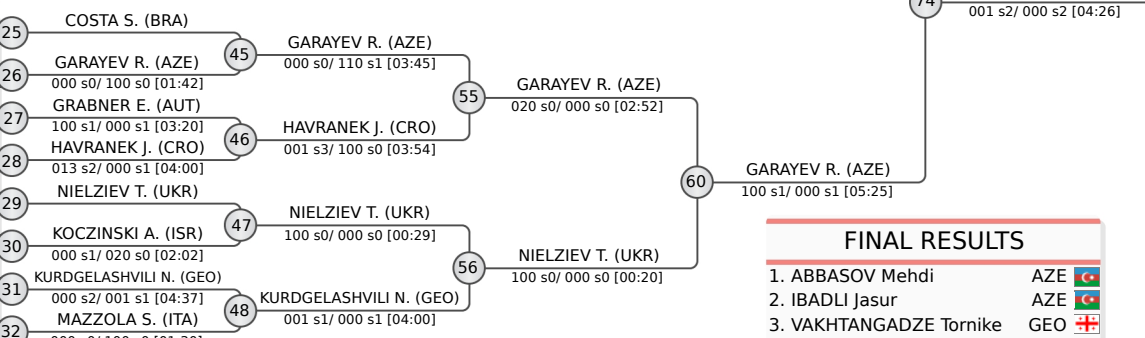

1.	ABBASOV Mehdi	AZE
2.	IBADLI Jasur	AZE
3.	VAKHTANGADZE Tornike	GEO
3.	COSTA Silas	BRA
5.	GARAYEV Roman	AZE
5.	NEYOLOV Artem	CAN
7.	RICHNER Suleyman	SUI
7.	ROEDER Henry	GER

REPECHAGE

61	ZALAGH R. (FRA)	FRA
62	DJURISIC B. (MNE)	MNE
63	NURBERGENOV O. (KAZ)	KAZ
64	COSTA S. (BRA)	BRA

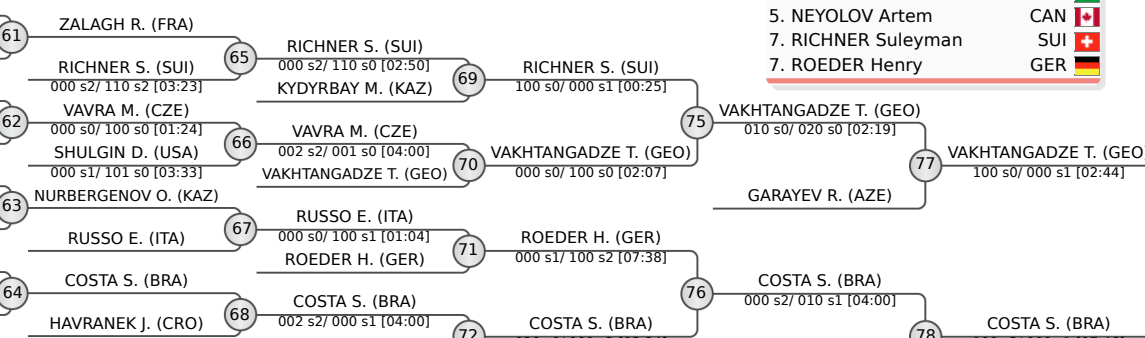



Prague Junior European Cup 2026

Czechia, Prague, 4-5 Jul 2026

-100 kg

Juniors (31)

POOL A

	LIUBIMOVSKI Daniel	USA
	FIORE Francesco	ITA
	BOISSONNET Hugo	FRA
	ZAALISHVILI Nikoloz	GEO
	BISCHOFF Samuel	GER
	JERABEK Martin	CZE
	YAKYMENKO Illia	UKR

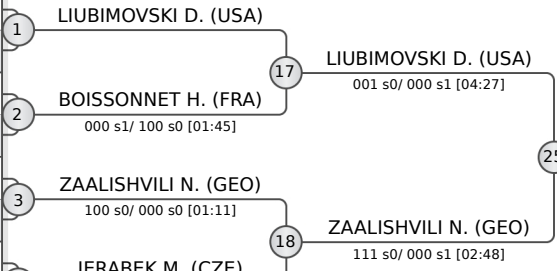

POOL B

	KIM Kyungmin	KOR
	ZIADI Yosef	ISR
	KOPRIVICA Jovan	SRB
	PENONE Yuri	ITA
	MAZZON Francesco	ITA
	RISUKHIN Bohdan	UKR
	ALIYEV Janpolad	AZE
	CALDER Jaden	GBR

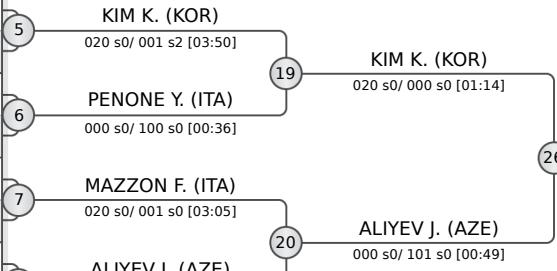

POOL C

	HADDAD Caedmon	USA
	VANEK Michal	CZE
	MAKARENKO Artur	UKR
	TATARU Gheorghe	GBR
	GELASHVILI Giorgi	GEO
	STOROZHUK Danilo	POR
	CAPPELLO Giorgio	ITA
	MOUSSIMA EWANE ELOUTI Franck David	CAN

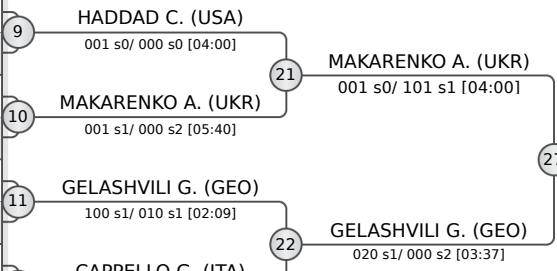

POOL D

	GENYS Majus	LTU
	AFANASJEVS Nikita	LAT
	SHYSHOV Mykhailo	UKR
	UZAN Amit Amos	ISR
	NAMAZLI Davud	AZE
	PAPUKISHVILI David	GEO
	BULATOVIC Pavle	MNE
	ARMANO Filippo	ITA

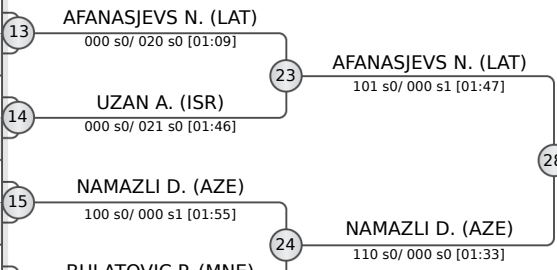

REPECHAGE

BISCHOFF S. (GER)	29	BISCHOFF S. (GER)	33
JERABEK M. (CZE)		LIUBIMOVSKI D. (USA)	
CALDER J. (GBR)		LIUBIMOVSKI D. (USA)	
MAZZON F. (ITA)	30	MAZZON F. (ITA)	34
STOROZHUK D. (POR)		MAZZON F. (ITA)	
CAPPELLO G. (ITA)	31	MAKARENKO A. (UKR)	35
PAPUKISHVILI D. (GEO)		MAKARENKO A. (UKR)	
BULATOVIC P. (MNE)	32	PAPUKISHVILI D. (GEO)	40
		PAPUKISHVILI D. (GEO)	
		AFANASJEVS N. (LAT)	36

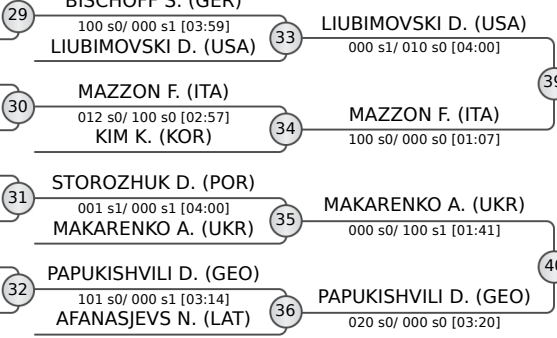

FINAL RESULTS	
1.	GELASHVILI Giorgi (GEO)
2.	ALIYEV Janpolad (AZE)
3.	NAMAZLI Davud (AZE)
3.	ZAALISHVILI Nikoloz (GEO)
5.	MAZZON Francesco (ITA)
7.	PAPUKISHVILI David (GEO)
7.	LIUBIMOVSKI Daniel (USA)
7.	MAKARENKO Artur (UKR)





Prague Junior European Cup 2026

Czechia, Prague, 4-5 Jul 2026

+100 kg

Juniors (20)

POOL A

	AHMADOV Ramazan	AZE
	ALBANO II Alexandre	BRA
	CESARINI Francesco	ITA
	MADEN Mahmutcan	TUR
	KOBALADZE Nodar	GEO

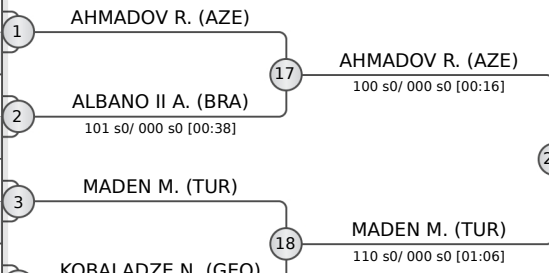

POOL B

	KIM Minjun	KOR
	DAMM Felix	GER
	FESENKO Oleh	UKR
	SCHARNER Oliver	AUT
	TRUHLAR Martin	CZE

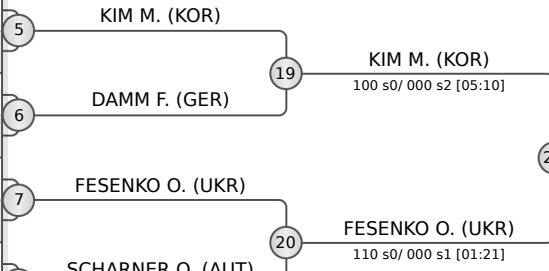

POOL C

	OMELCHENKO Yaroslav	UKR
	MARKOV Nikola	BUL
	ENDELADZE Uta	ITA
	SEDLAK Martin	CZE
	KOVINIC Stefan	MNE

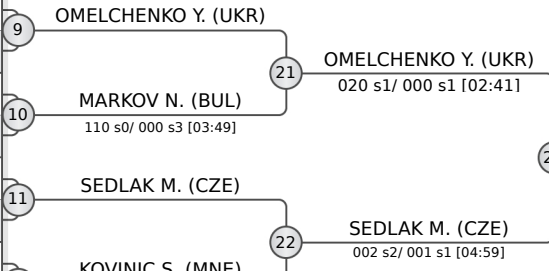

POOL D

	SULTAN Beibarys	KAZ
	KOSTELIDIS Ioannis	GRE
	SCHINDLER Lasse Tjark	GER
	KARCHAIDZE Giorgi	GEO
	CORSICA Michele	ITA

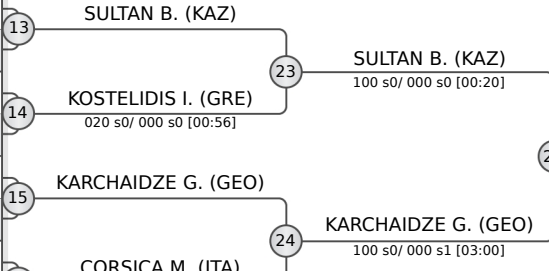

REPECHAGE

29	ALBANO II A. (BRA)	33	MADEN M. (TUR)
30	DAMM F. (GER)	34	FESENKO O. (UKR)
31	MARKOV N. (BUL)	35	SEDLAK M. (CZE)
32	KOSTELIDIS I. (GRE)	36	KARCHAIDZE G. (GEO)



FINAL RESULTS	
1.	AHMADOV Ramazan AZE
2.	SULTAN Beibarys KAZ
3.	ALBANO II Alexandre BRA
3.	KARCHAIDZE Giorgi GEO
5.	OMELCHENKO Yaroslav UKR
5.	KIM Minjun KOR
7.	FESENKO Oleh UKR
7.	MARKOV Nikola BUL





Prague Junior European Cup 2026

Czechia, Prague, 4-5 Jul 2026

-48 kg

Juniors (20)

POOL A

	MENDES Sarah	BRA
	BROVOLD Selma	NOR
	LISOHOROVA Alona	UKR
	CESANA Chiara	ITA
	VEILLARD Melody	SUI

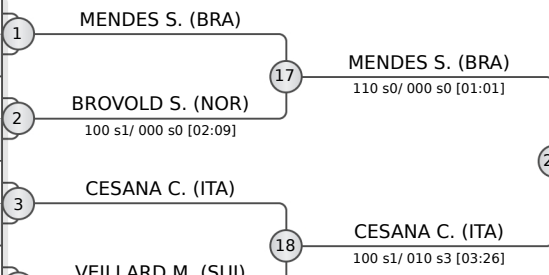

POOL B

	EWING Eva	GBR
	LEE Yoojin	KOR
	WAKABAYASHI Miyu	JPN
	AUER Nina	AUT
	PISATURO Giulia	ITA

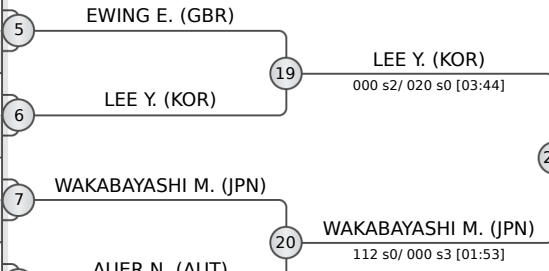

POOL C

	RANGELOVA Sofia	BUL
	MAYRHOFER Lena	AUT
	ERB Alexandra	USA
	PEREIRA Mariana	POR
	AUREL Mathilde	FRA

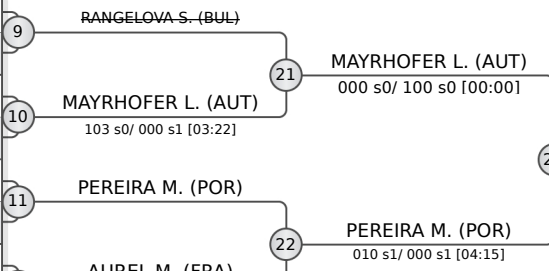

POOL D

	PETRENKO Liliia	UKR
	AHMADOVA Nargiz	AZE
	KUTENKOVA Mariia	UKR
	ZEDDA Roberta	ITA
	HIROSE Rio	AUS

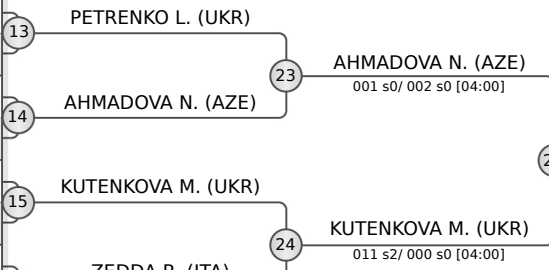

FINAL RESULTS	
1. MENDES Sarah	BRA
2. AHMADOVA Nargiz	AZE
3. WAKABAYASHI Miyu	JPN
3. LEE Yoojin	KOR
5. MAYRHOFER Lena	AUT
5. PEREIRA Mariana	POR
7. CESANA Chiara	ITA
7. PETRENKO Liliia	UKR

REPECHAGE

BROVOLD S. (NOR)	29	BROVOLD S. (NOR)	33	CESANA C. (ITA)
EWING E. (GBR)	30	EWING E. (GBR)	34	WAKABAYASHI M. (JPN)
ERB A. (USA)	31	ERB A. (USA)	35	PEREIRA M. (POR)
RANGELOVA S. (BUL)	31	RANGELOVA S. (BUL)	35	PEREIRA M. (POR)
PETRENKO L. (UKR)	32	PETRENKO L. (UKR)	36	PETRENKO L. (UKR)
		KUTENKOVA M. (UKR)	36	PETRENKO L. (UKR)

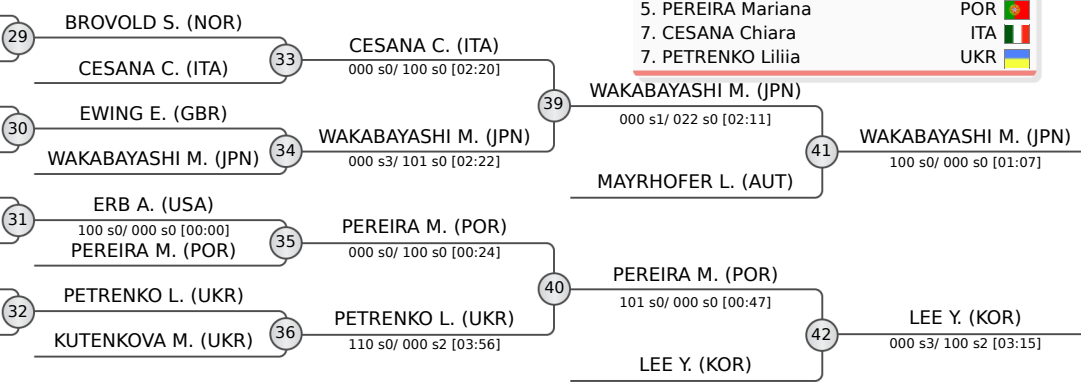



Prague Junior European Cup 2026

Czechia, Prague, 4-5 Jul 2026

-52 kg

Juniors (24)

POOL A

	MARQUES Nicole	BRA
	CIALINI Beatrice	ITA
	HODGKINSON Daisy	GBR
	TORO Asia	ITA
	MIRZAYEVA Farida	AZE
	BAEK Jiho	KOR

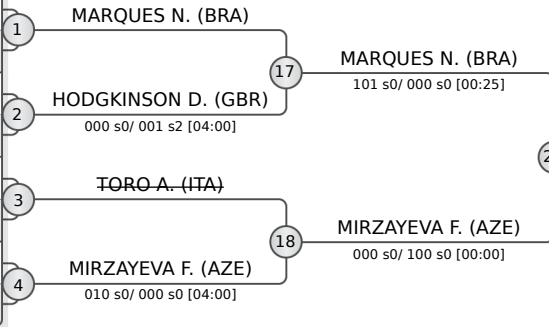

POOL B

	MIROSHNICHENKO Marharyta	UKR
	AGUMAVA Roza	GER
	TAMURA Addyson	CAN
	HRECHKA Sofia	UKR
	NIUTTA Sofia	ITA
	MANIBOG Malia	USA

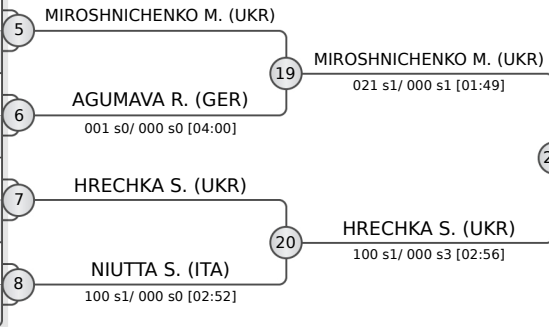

POOL C

	BOURIHANE Rima	CAN
	NETTESHEIM Charlotte	GER
	BONZANO Giulia	ITA
	ALDER Amelia	GBR
	AIROLA GRANACI Iulia	ITA
	FOURNIAT Elodie	FRA

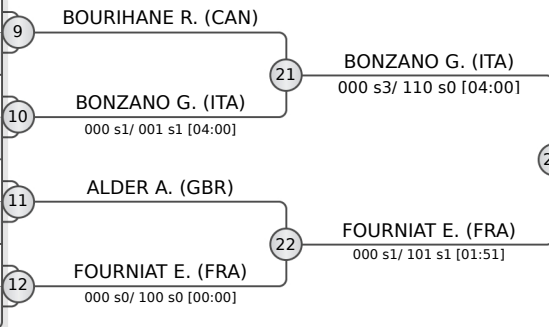

POOL D

	BERSELLINI Alice	ITA
	HAJIZADA Nurana	AZE
	CHERNUKHA Veronika	UKR
	MCPHERSON Mackenzie	USA
	TWAROWSKA Barbara	POL
	SERAFINI India	ITA

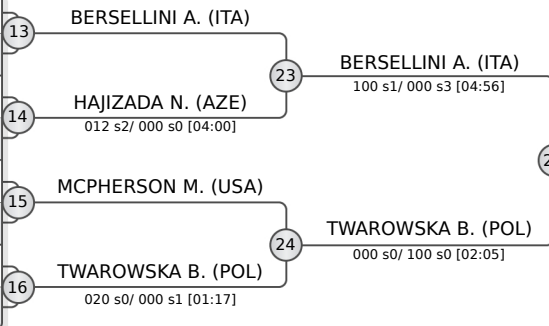

FINAL RESULTS	
1.	TWAROWSKA Barbara POL
2.	MARQUES Nicole BRA
3.	AGUMAVA Roza GER
3.	SERAFINI India ITA
5.	BONZANO Giulia ITA
5.	MIROSHNICHENKO Marharyta UKR
7.	MIRZAYEVA Farida AZE
7.	FOURNIAT Elodie FRA

REPECHAGE

HODGKINSON D. (GBR)	29	HODGKINSON D. (GBR)
AGUMAVA R. (GER)	30	AGUMAVA R. (GER)
NETTESHEIM C. (GER)	31	BOURIHANE R. (CAN)
BOURIHANE R. (CAN)	31	BOURIHANE R. (CAN)
SERAFINI I. (ITA)	32	SERAFINI I. (ITA)
MCPHERSON M. (USA)	32	MCPHERSON M. (USA)

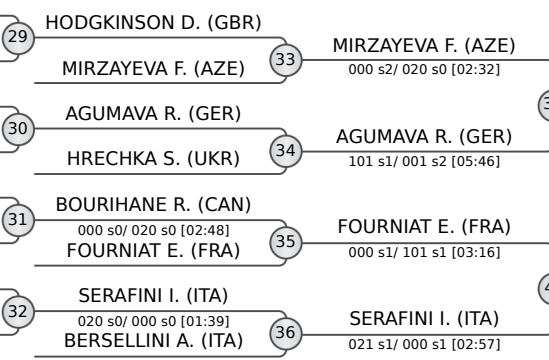



Prague Junior European Cup 2026

Czechia, Prague, 4-5 Jul 2026

-57 kg

Juniors (30)

POOL A

	GAGNON Laurence	CAN
	MASTROPIETRO Ludovica	ITA
	CLARK Elsa	USA
	KORCAKOVA Marketa	CZE
	SEMOUD Luna	GER
	TUCAJ Martina	CRO
	VERDIYEVA Aytan	AZE

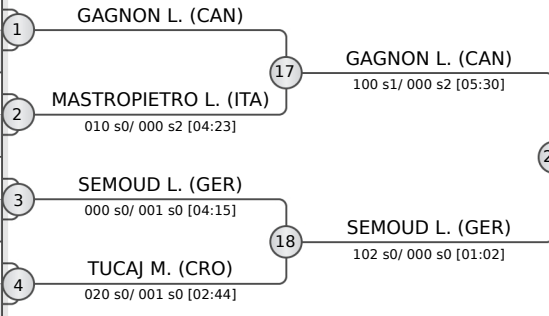

POOL B

	MENEZES Larissa	BRA
	KISSENISKY Maddy	GBR
	SEVERYN Anastasiia	UKR
	HAJIYEVA Vusala	AZE
	SORELLI Giulia	ITA
	MANAILA Nicole Daria	CAN
	BELLEVAL Jaines	FRA
	POSPISILOVA Adela	CZE

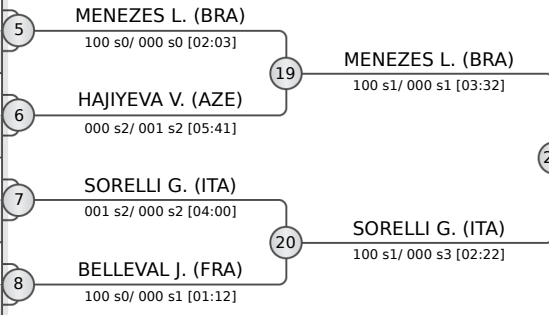

POOL C

	KUCHAR Varvara	LTU
	HILLER Harlee	USA
	HERMANOVA Karolina	CZE
	MARTELLACCI Alice	ITA
	GADASHOVA Khadizha	AZE
	GRENIER Melody	CAN
	ZUEND Annika	SUI

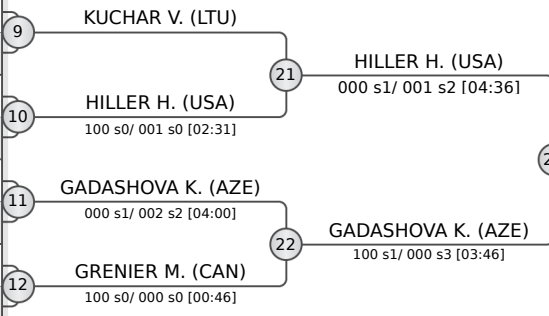

POOL D

	KELLY Oren	AUS
	HADAR Noa	ISR
	FRADE Victoria	BRA
	MOMOT Neonila	UKR
	AZINOOU Marina	CYP
	KOSTROVETS Valeria	CAN
	MERTLOVA Andrea	CZE
	STORIONE Elena	ITA

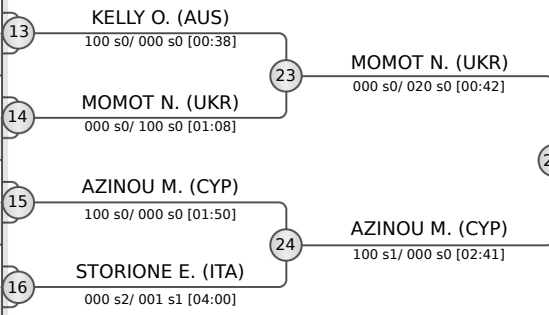

REPECHAGE

KORCAKOVA M. (CZE)	29	KORCAKOVA M. (CZE)	33
TUCAJ M. (CRO)		GAGNON L. (CAN)	
KISSENISKY M. (GBR)	30	KISSENISKY M. (GBR)	34
HAJIYEVA V. (AZE)		SORELLI G. (ITA)	
MARTELLACCI A. (ITA)	31	MARTELLACCI A. (ITA)	35
GRENIER M. (CAN)		HILLER H. (USA)	
FRADE V. (BRA)	32	FRADE V. (BRA)	36
KELLY O. (AUS)		AZINOOU M. (CYP)	

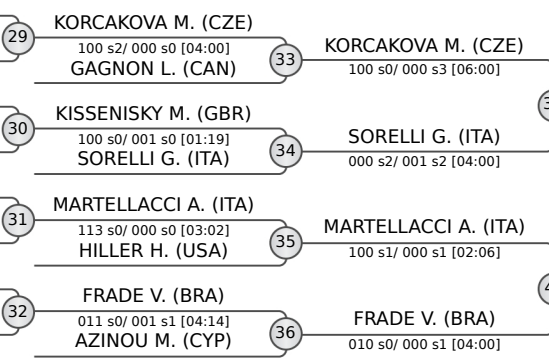

FINAL RESULTS	
1.	MOMOT Neonila
2.	SEMOUD Luna
3.	GADASHOVA Khadizha
3.	MARTELLACCI Alice
5.	SORELLI Giulia
5.	MENEZES Larissa
7.	KORCAKOVA Marketa
7.	FRADE Victoria





Prague Junior European Cup 2026

Czechia, Prague, 4-5 Jul 2026

-63 kg

Juniors (37)

POOL A

1	TANDEAN Bianca (AUS)	33	THOMSON M. (CAN)
2	THOMSON Maia (CAN)	34	MORUZZI R. (ITA)
3	FONSECA L. (BRA)	35	FROSONI G. (ITA)
4	FONSECA Laryssa (BRA)	36	YANG J. (KOR)
5	MORUZZI Rachele (ITA)	37	JASPE E. (USA)
6	FROSONI Giorgia (ITA)	38	RZAYEVA N. (AZE)
7	MUELLER K. (GER)	39	ROTTENHOFER H. (AUT)
8	CECHOVA Veronika (CZE)	40	MATUSZEKOVA P. (SVK)
	KABA Kadidja (FRA)	41	VAN ZYL C. (CAN)
	YANG Jieon (KOR)	42	SISKOVA S. (CZE)

POOL B

9	JASPE Emily Daniela (USA)	43	PAGLIARO M. (ITA)
10	COMBA Anita (ITA)	44	VUKADINOVIC D. (SRB)
11	ALEMPS Zoe (FRA)	45	MAIA M. (BRA)
12	ZHAISSANGBAY Zhibek (KAZ)	46	ZAMBON R. (ITA)
13	RZAYEVA Nilgun (AZE)	47	ABBOTT E. (USA)
14	ROTTENHOFER Helena (AUT)	48	BOICHENKO D. (UKR)
15	GAMBARDELLA Nina (ITA)	49	ORIMO Toa (JPN)
16	MATUSZEKOVA Paula (SVK)	50	ORIMO T. (JPN)
17	VONDRAKOVA Lada (CZE)	51	JASPE E. (USA)
		52	ROTTENHOFER H. (AUT)
		53	VAN ZYL C. (CAN)
		54	PAGLIARO M. (ITA)
		55	MAIA M. (BRA)
		56	ORIMO T. (JPN)
		57	FROSONI G. (ITA)
		58	ROTTENHOFER H. (AUT)
		59	VAN ZYL C. (CAN)
		60	ORIMO T. (JPN)
		61	MUELLER K. (GER)
		62	GAMBARDELLA N. (ITA)
		63	BLOCHE M. (FRA)
		64	BOICHENKO D. (UKR)
		65	YANG J. (KOR)
		66	MATUSZEKOVA P. (SVK)
		67	SISKOVA S. (CZE)
		68	BOICHENKO D. (UKR)
		69	YANG J. (KOR)
		70	JASPE E. (USA)
		71	PAGLIARO M. (ITA)
		72	MAIA M. (BRA)
		73	FROSONI G. (ITA)
		74	ORIMO T. (JPN)
		75	JASPE E. (USA)
		76	MAIA M. (BRA)
		77	VAN ZYL C. (CAN)
		78	MAIA M. (BRA)
		79	ORIMO T. (JPN)

POOL C

17	VAN ZYL Carla (CAN)	41	VAN ZYL C. (CAN)
18	BLOCHE Manon (FRA)	42	SISKOVA S. (CZE)
19	SISKOVA Stela (CZE)	43	PAGLIARO M. (ITA)
20	CARDELLA Sara (ITA)	44	VUKADINOVIC D. (SRB)
21	SILVEIRA Maria (POR)	45	MAIA M. (BRA)
22	PAGLIARO Maila (ITA)	46	ZAMBON R. (ITA)
23	VUKADINOVIC Djurdja (SRB)	47	ABBOTT E. (USA)
24	BACHLER Anna (AUT)	48	BOICHENKO D. (UKR)
	DRDAKOVA Martina (SVK)	49	ORIMO Toa (JPN)
		50	ORIMO T. (JPN)
		51	JASPE E. (USA)
		52	ROTTENHOFER H. (AUT)
		53	VAN ZYL C. (CAN)
		54	PAGLIARO M. (ITA)
		55	MAIA M. (BRA)
		56	ORIMO T. (JPN)
		57	FROSONI G. (ITA)
		58	ROTTENHOFER H. (AUT)
		59	VAN ZYL C. (CAN)
		60	ORIMO T. (JPN)
		61	MUELLER K. (GER)
		62	GAMBARDELLA N. (ITA)
		63	BLOCHE M. (FRA)
		64	BOICHENKO D. (UKR)
		65	YANG J. (KOR)
		66	MATUSZEKOVA P. (SVK)
		67	SISKOVA S. (CZE)
		68	BOICHENKO D. (UKR)
		69	YANG J. (KOR)
		70	JASPE E. (USA)
		71	PAGLIARO M. (ITA)
		72	MAIA M. (BRA)
		73	FROSONI G. (ITA)
		74	ORIMO T. (JPN)
		75	JASPE E. (USA)
		76	MAIA M. (BRA)
		77	VAN ZYL C. (CAN)
		78	MAIA M. (BRA)
		79	ORIMO T. (JPN)

POOL D

25	MAIA Manuela (BRA)	45	MAIA M. (BRA)
26	PELCLOVA Kristyna (CZE)	46	ZAMBON R. (ITA)
27	ZAMBON Reika (ITA)	47	ABBOTT E. (USA)
28	ABBOTT Ellianna (USA)	48	BOICHENKO D. (UKR)
29	BOICHENKO Daria (UKR)	49	ORIMO Toa (JPN)
30	ORIMO Toa (JPN)	50	ORIMO T. (JPN)
31	JURKUTAT Laura (GER)	51	JASPE E. (USA)
32	CAVAGLIA Marika (ITA)	52	ROTTENHOFER H. (AUT)
	BOLTVANNOVA Lea (SVK)	53	VAN ZYL C. (CAN)
		54	PAGLIARO M. (ITA)
		55	MAIA M. (BRA)
		56	ORIMO T. (JPN)
		57	FROSONI G. (ITA)
		58	ROTTENHOFER H. (AUT)
		59	VAN ZYL C. (CAN)
		60	ORIMO T. (JPN)
		61	MUELLER K. (GER)
		62	GAMBARDELLA N. (ITA)
		63	BLOCHE M. (FRA)
		64	BOICHENKO D. (UKR)
		65	YANG J. (KOR)
		66	MATUSZEKOVA P. (SVK)
		67	SISKOVA S. (CZE)
		68	BOICHENKO D. (UKR)
		69	YANG J. (KOR)
		70	JASPE E. (USA)
		71	PAGLIARO M. (ITA)
		72	MAIA M. (BRA)
		73	FROSONI G. (ITA)
		74	ORIMO T. (JPN)
		75	JASPE E. (USA)
		76	MAIA M. (BRA)
		77	VAN ZYL C. (CAN)
		78	MAIA M. (BRA)
		79	ORIMO T. (JPN)

REPECHAGE

61	MUELLER K. (GER)	65	YANG J. (KOR)	69	YANG J. (KOR)	75	JASPE E. (USA)	77	VAN ZYL C. (CAN)
			THOMSON M. (CAN)		101 s0/000 s0 [01:57]		000 s0/100 s0 [01:13]		000 s2/001 s1 [04:32]
62	GAMBARDELLA N. (ITA)	66	MATUSZEKOVA P. (SVK)	70	JASPE E. (USA)	71	PAGLIARO M. (ITA)	76	MAIA M. (BRA)
			MATUSZEKOVA P. (SVK)		000 s0/100 s1 [04:00]		000 s0/110 s1 [03:27]		000 s0/101 s1 [03:22]
63	BLOCHE M. (FRA)	67	SISKOVA S. (CZE)	72	MAIA M. (BRA)	73	FROSONI G. (ITA)	78	MAIA M. (BRA)
			PAGLIARO M. (ITA)		001 s1/010 s0 [04:00]		000 s3/100 s2 [03:46]		100 s0/000 s1 [02:04]
64	BOICHENKO D. (UKR)	68	BOICHENKO D. (UKR)		000 s1/100 s1 [04:00]		000 s3/100 s2 [03:46]		
			CAVAGLIA M. (ITA)				000 s3/100 s2 [03:46]		

FINAL RESULTS		
1.	ORIMO Toa	JPN
2.	FROSONI Giorgia	ITA
3.	VAN ZYL Carla	CAN
3.	MAIA Manuela	BRA
5.	JASPE Emily Daniela	USA
5.	ROTTENHOFER Helena	AUT
7.	YANG Jieon	KOR
7.	PAGLIARO Maila	ITA





Prague Junior European Cup 2026

Czechia, Prague, 4-5 Jul 2026

-70 kg

Juniors (27)

POOL A

	THIBAUT Charlie	CAN
	MO Sumin	KOR
	COUTO HOTTIS Maria Julia	ITA
	NAVICKAITE Marta	LTU
	MOREIRA Ana Beatriz	BRA
	WINTER Leya	GER
	NEMCOVA Barbora	CZE

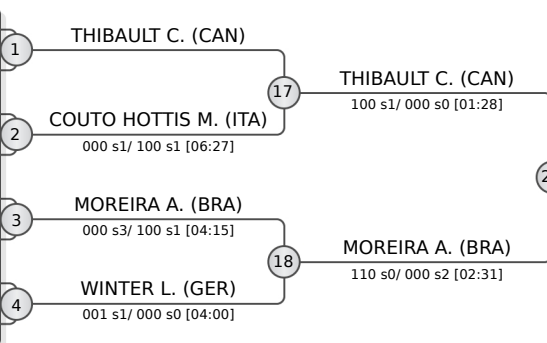

POOL B

	DORVAL MBELE Missy Jen	CAN
	JURCIKOVA Viktorie	CZE
	DIALLO Malika	FRA
	CAMARA Sophia	BRA
	GRASSI Giorgia	ITA
	OMACKOVA Amalie	CZE

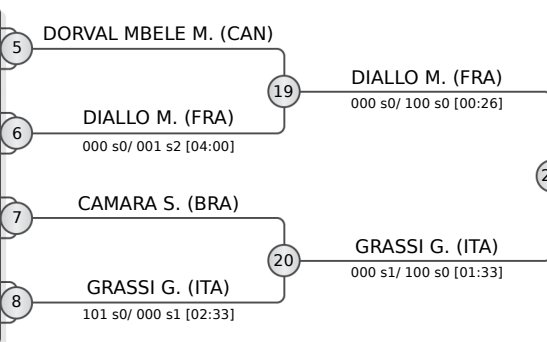

POOL C

	VALLIM Clarisse	BRA
	ESPOSITO Alessia	ITA
	SEDIVA Adela	CZE
	VIRGILIO Sara	ITA
	SCHLIEPER Carlotta	GER
	MORINO Chiharu	JPN
	SPERLING Anna Julia	BRA

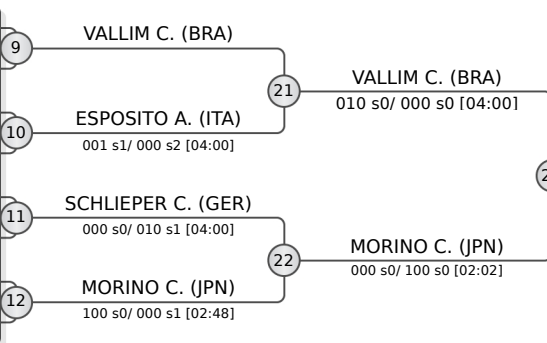

POOL D

	JAAFAR Nadie	BUL
	PONOMARJOVA Sofija	LAT
	KUCEROVA Anna	CZE
	VOZNIUK Liudmyla	UKR
	CAPUANO Irene	ITA
	GRAMBO Anna	NOR
	GIACHINI Mariana	BRA

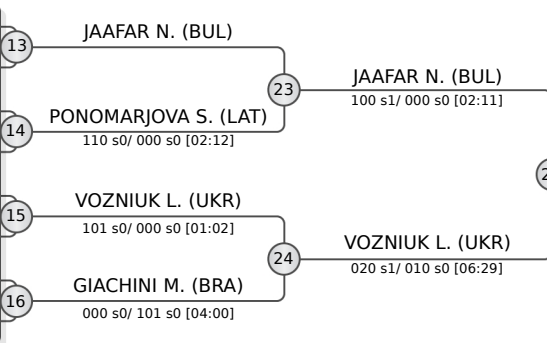

FINAL RESULTS		
1.	VOZNIUK Liudmyla	UKR
2.	GRASSI Giorgia	ITA
3.	MORINO Chiharu	JPN
3.	VALLIM Clarisse	BRA
5.	CAMARA Sophia	BRA
5.	THIBAUT Charlie	CAN
7.	COUTO HOTTIS Maria Julia	ITA
7.	JAAFAR Nadie	BUL

REPECHAGE

COUTO HOTTIS M. (ITA) (29)	COUTO HOTTIS M. (ITA) (33)
OMACKOVA A. (CZE) (30)	CAMARA S. (BRA) (34)
CAMARA S. (BRA) (30)	DIALLO M. (FRA) (34)
SPERLING A. (BRA) (31)	SPERLING A. (BRA) (35)
SCHLIEPER C. (GER) (31)	VALLIM C. (BRA) (35)
CAPUANO I. (ITA) (32)	GIACHINI M. (BRA) (36)
GIACHINI M. (BRA) (32)	JAAFAR N. (BUL) (36)

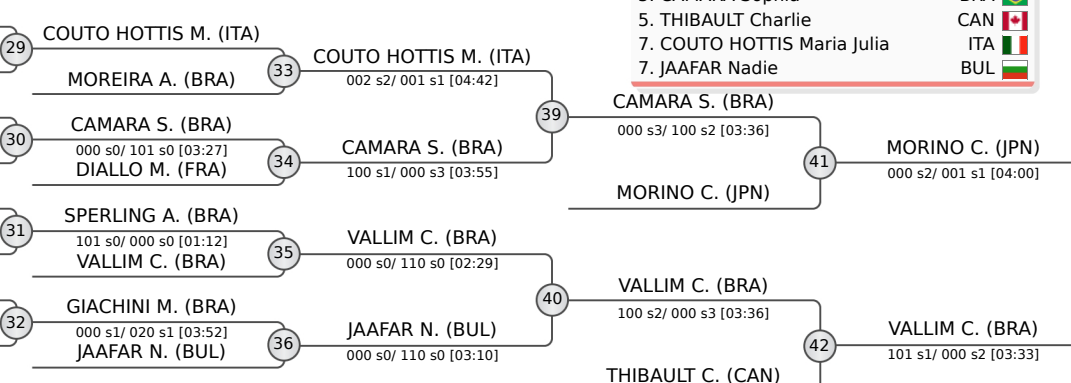



Prague Junior European Cup 2026

Czechia, Prague, 4-5 Jul 2026

-78 kg

Juniors (14)

POOL A

	KLINGER Johanna Elisabeth	BIH
	MENANTEAU Jeanne	FRA
	KIM Goeun	KOR

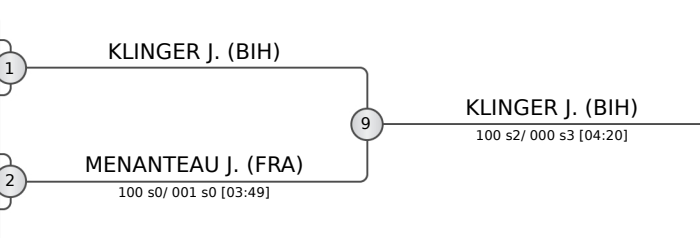

POOL B

	MAGLI Lucia	ITA
	TITOVETS Kira	UKR
	MANUKYAN Mia	GER
	KATSUMATA Misuzu	JPN

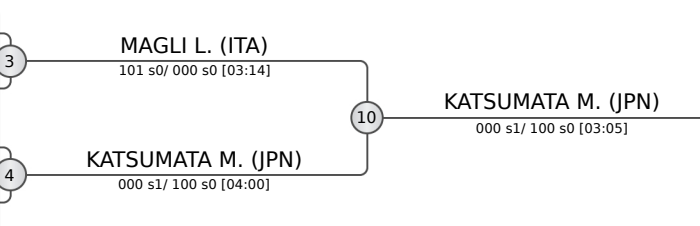

POOL C

	KOSNAROVA Marie	CZE
	JOHANNESSEN Eva	NOR
	TKACHOVA Anna	UKR

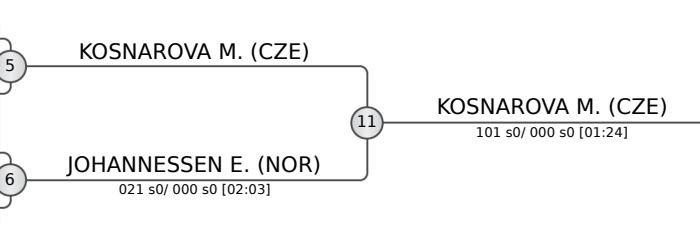

POOL D

	AKHMETOVA Saltanat	KAZ
	OTAWA Kokoro	JPN
	YERGALI Tomiris	KAZ
	BESKER Ana	CRO

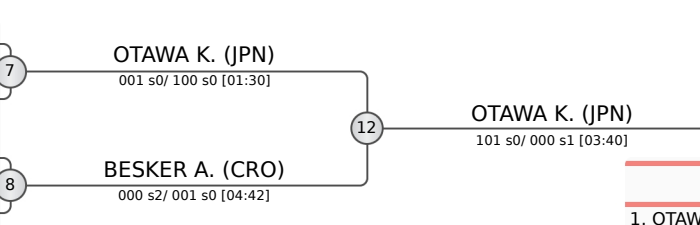

FINAL RESULTS		
1.	OTAWA Kokoro	JPN
2.	KATSUMATA Misuzu	JPN
3.	MENANTEAU Jeanne	FRA
3.	KLINGER Johanna Elisabeth	BIH
5.	KOSNAROVA Marie	CZE
5.	BESKER Ana	CRO
7.	MAGLI Lucia	ITA
7.	JOHANNESSEN Eva	NOR

REPECHAGE

MENANTEAU J. (FRA)	13	MENANTEAU J. (FRA)
MANUKYAN M. (GER)		
MAGLI L. (ITA)	14	MAGLI L. (ITA)
JOHANNESSEN E. (NOR)	15	JOHANNESSEN E. (NOR)
AKHMETOVA S. (KAZ)		
BESKER A. (CRO)	16	BESKER A. (CRO)

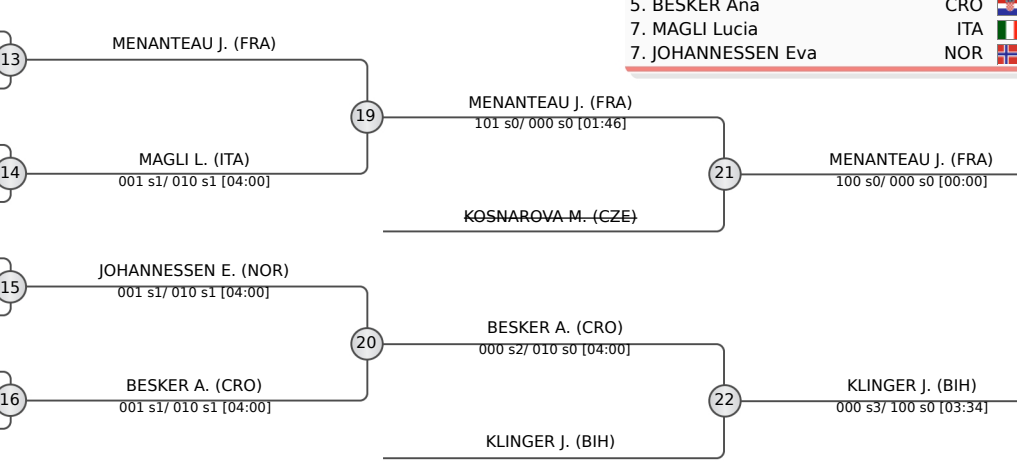



Prague Junior European Cup 2026

Czechia, Prague, 4-5 Jul 2026

+78 kg

Juniors (15)

POOL A

	SOARES Ana	BRA
	KUBLER Sofia	ITA
	INOUE Tomoka	JPN

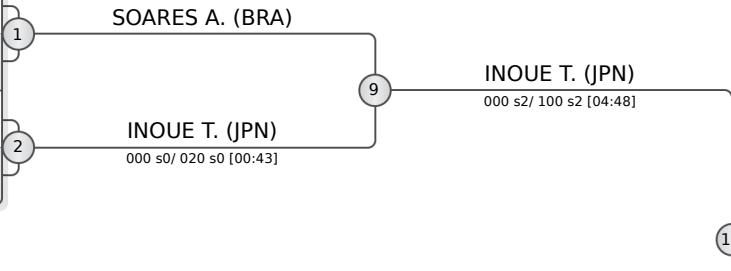

POOL B

	OLIVEIRA Olivia	BRA
	NOVAR Noemie	FRA
	EBONA Tessa	SUI
	BAHMET Kira	UKR

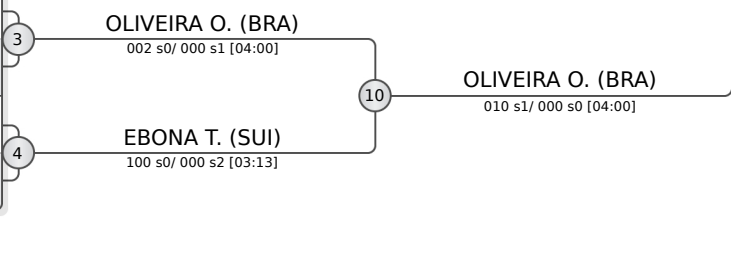

POOL C

	LAVIGNE Frederique	CAN
	LANDOLFA Valeria Luisa Maria	ITA
	HEURTEAU Bleuene	FRA
	NAGASATO Sakura	JPN

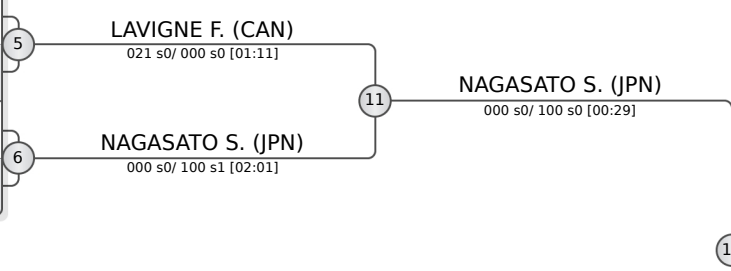

POOL D

	FILKOROVA Nina	SVK
	LEE Seungjin	KOR
	TELESCA Giulia	ITA
	SAMOLIUK Anna	UKR

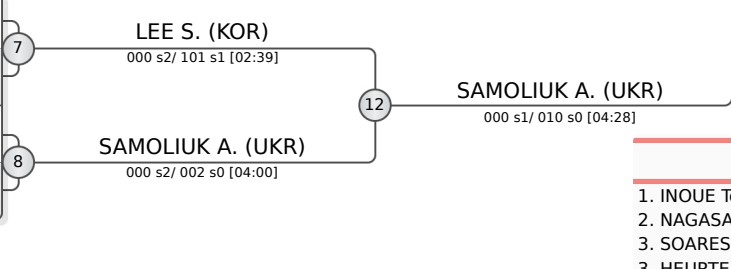

REPECHAGE

KUBLER S. (ITA)	SOARES A. (BRA)
NOVAR N. (FRA)	EBONA T. (SUI)
HEURTEAU B. (FRA)	HEURTEAU B. (FRA)
LAVIGNE F. (CAN)	LEE S. (KOR)

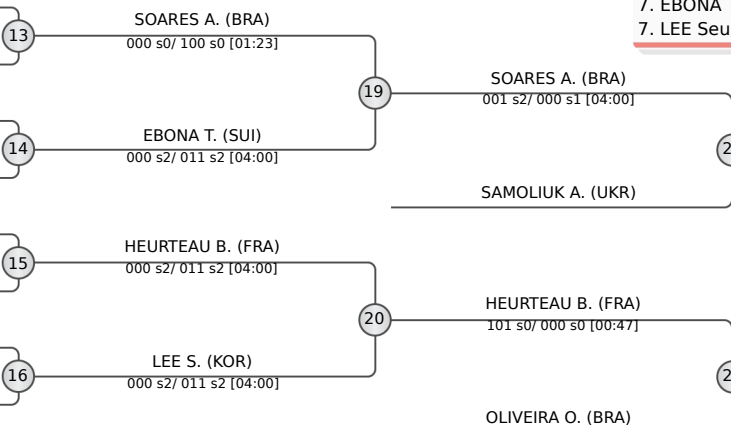

FINAL RESULTS		
1.	INOUE Tomoka	JPN
2.	NAGASATO Sakura	JPN
3.	SOARES Ana	BRA
3.	HEURTEAU Bleuene	FRA
5.	SAMOLIUK Anna	UKR
5.	OLIVEIRA Olivia	BRA
7.	EBONA Tessa	SUI
7.	LEE Seungjin	KOR

