



Podgorica Senior European Cup 2025

Montenegro, Podgorica, 8-9 Mar 2025

-60 kg
Men (18)

POOL A

	HOWARD Benjamin	GER
	IGNASIAK Ksawery	POL
	ERGUN Alperen	TUR
	ANDJELOVIC Rastko	SRB
	ANDREINI Pietro	ITA

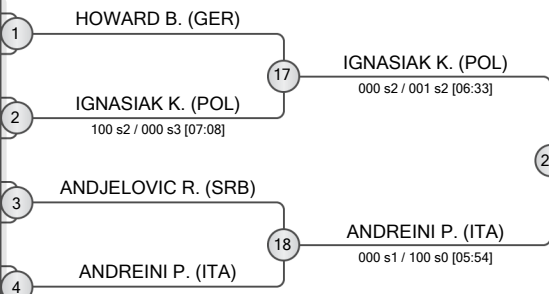

POOL B

	LEDJANSKI Ivan	SRB
	TIRSINA Alexandru	MDA
	FITYKA Mateusz	POL
	CIVOVIC Edvin	MNE

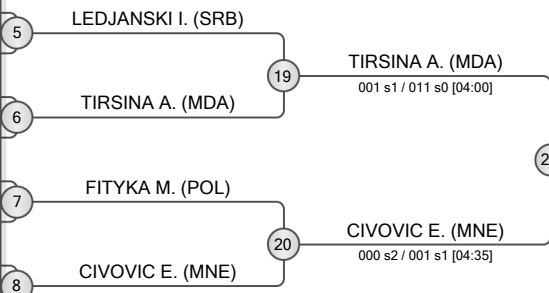

POOL C

	BLASZCZAK Igor	POL
	NIKOLIC Aleksa	SRB
	DAFALLAH Ayoub	GBR
	LATSCHINJAN Hratschik	GER
	KARAHAN Emirhan	TUR

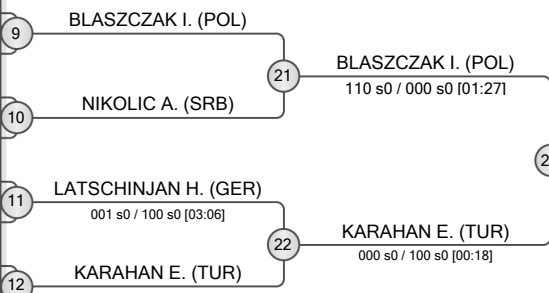

POOL D

	MUSIC Ilija	MNE
	MANFERLOTTI Vincenzo	ITA
	TURKMAN Tuncay	TUR
	GRIGOROV Lyuboslav	BUL

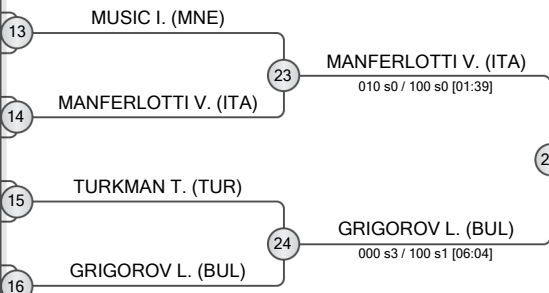

FINAL RESULTS

- TIRSINA Alexandru (MDA)
- MANFERLOTTI Vincenzo (ITA)
- ANDREINI Pietro (ITA)
- IGNASIAK Ksawery (POL)
- BLASZCZAK Igor (POL)
- KARAHAN Emirhan (TUR)
- CIVOVIC Edvin (MNE)
- GRIGOROV Lyuboslav (BUL)

REPECHAGE

ERGUN A. (TUR)	ERGUN A. (TUR)
HOWARD B. (GER)	ANDREINI P. (ITA)
LEDJANSKI I. (SRB)	CIVOVIC E. (MNE)
NIKOLIC A. (SRB)	KARAHAN E. (TUR)
MUSIC I. (MNE)	GRIGOROV L. (BUL)

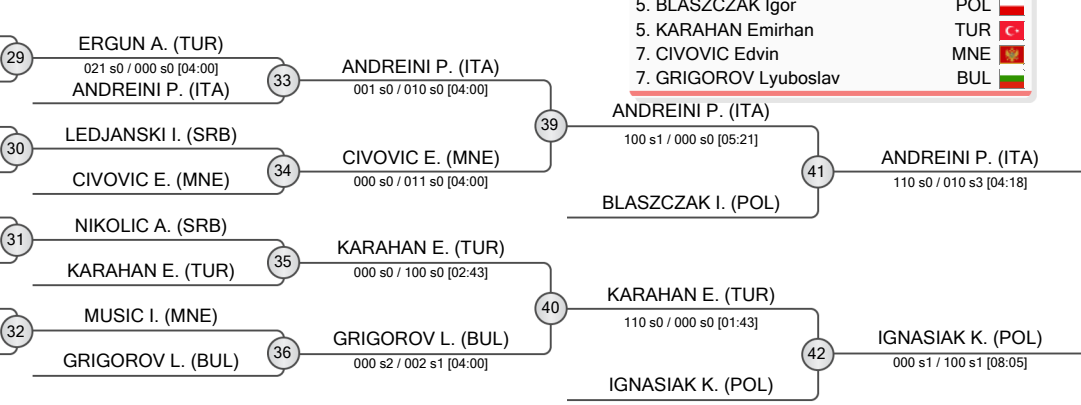



Podgorica Senior European Cup 2025

Montenegro, Podgorica, 8-9 Mar 2025

-66 kg

Men (37)

POOL A

1	YOUNG Charlie	GBR
2	SINANOVIC Emil	MNE
3	BURK Lenny Linus	GER
4	RESHITAJ Andi	KOS
5	KLACAR Dani	CRO
6	TOKTAY Davut	TUR
7	MORELLI Nicolo'	ITA
8	KLODA Gal	ISR
8	KUZHEV Tamerlan	IJF

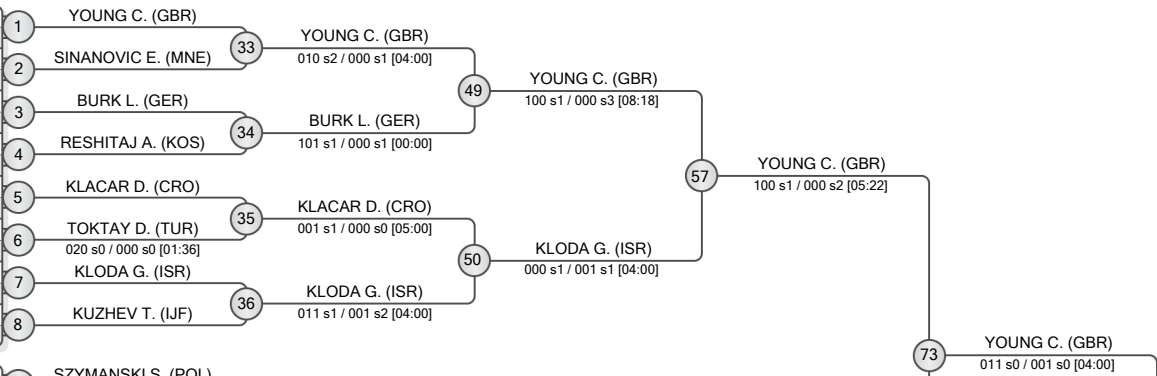

POOL B

9	SZYMANSKI Szymon	POL
10	BOZKURT Ali	TUR
11	KRSMANOVIC Pavle	SRB
12	ZAMBATOV Kantemir	IJF
13	KOKALJ Gasper	SLO
14	RADOVIC Petar	MNE
15	GOGUA Theodoros	GRE
16	TUMASIANIS Levon	IJF
16	GUSTIUC Tudor	MDA

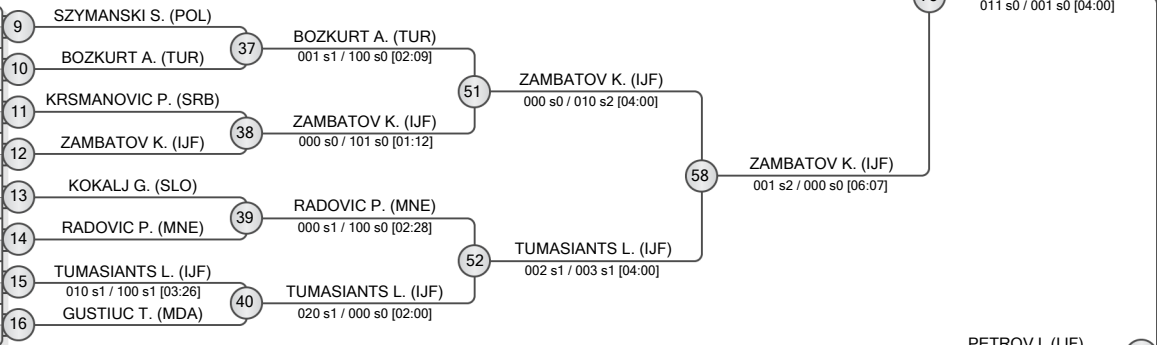

POOL C

17	CAGGIANO Luca	ITA
18	EFIMENKO Dmitrii	IJF
19	AKKUS Mhrac	TUR
20	FRYER Lewis	GBR
21	KURPEJOVIC Abid	MNE
22	ZOROTOVIC Nikola	CRO
23	ANASTASOPOULOS Adam	GRE
24	HERRMANN Liam	GER
24	MATIC Niksa	BIH
24	KEZIC Dusan	SRB

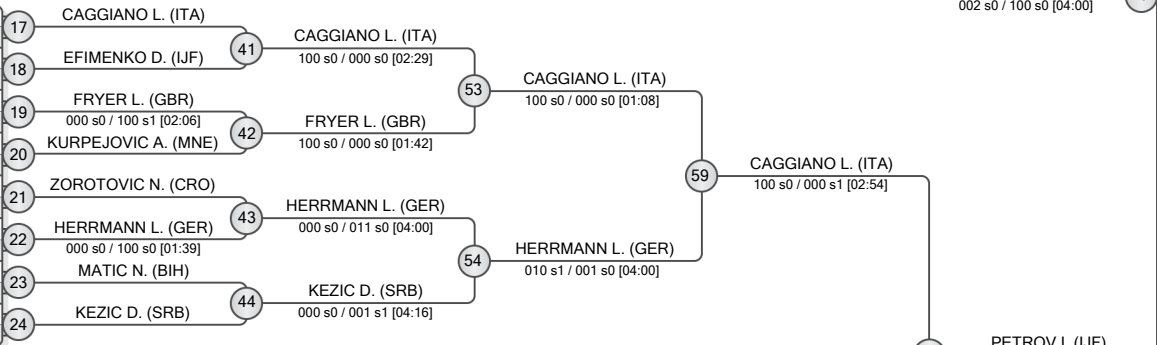

POOL D

25	KLIMKIEWICZ Krzysztof	POL
26	DINC Tunahan	TUR
27	PETROV Ivan	IJF
28	RIPSATER Isac	SWE
29	VESELI Muhamedin	KOS
30	ZENDER Piotr	POL
31	JEREMIC Matija	SRB
32	ELDIC Ivan	CRO
33	MISOAGA Manuel	ITA

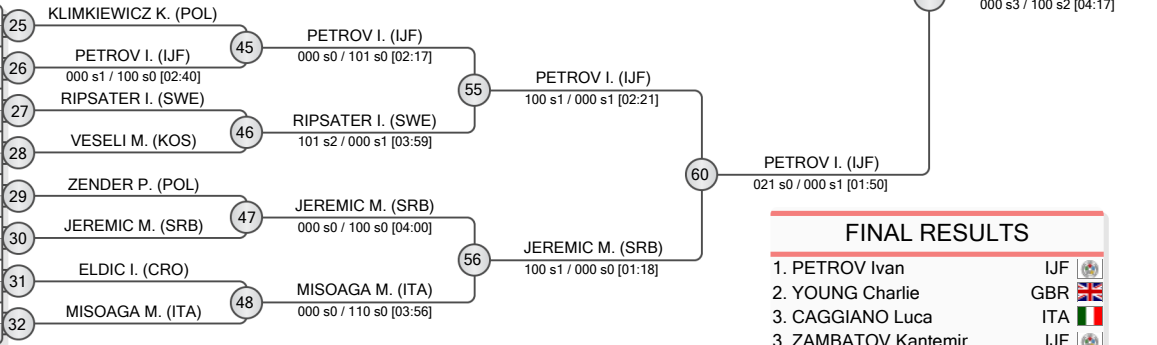

FINAL RESULTS		
1.	PETROV Ivan	IJF
2.	YOUNG Charlie	GBR
3.	CAGGIANO Luca	ITA
3.	ZAMBATOV Kantemir	IJF
5.	BOZKURT Ali	TUR
5.	RIPSATER Isac	SWE
7.	KLODA Gal	ISR
7.	HERRMANN Liam	GER

REPECHAGE

61	SINANOVIC E. (MNE)
62	KRSMANOVIC P. (SRB)
63	EFIMENKO D. (IJF)
64	KLIMKIEWICZ K. (POL)

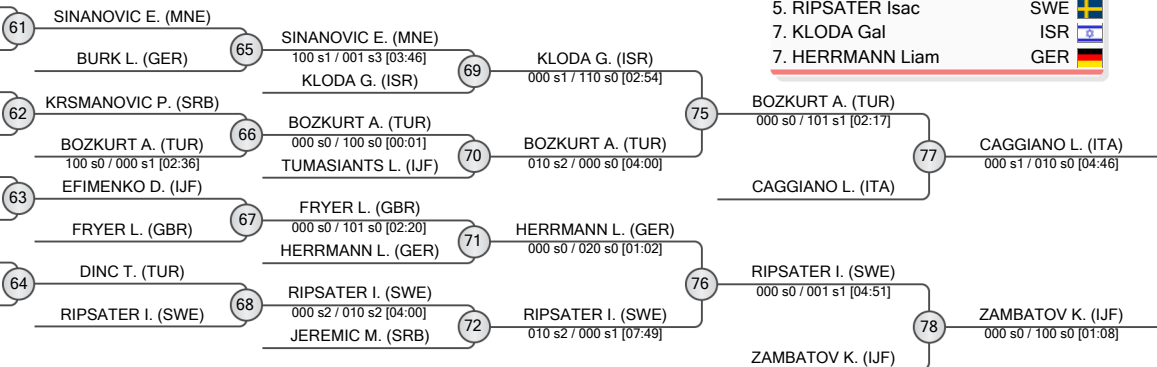



Podgorica Senior European Cup 2025

Montenegro, Podgorica, 8-9 Mar 2025

-73 kg

Men (43)

POOL A

STODOLSKI Adam	POL
PERISIC Djordje	MNE
SHARAPOLLI Dion	KOS
KUZNETSOV Dmitrii	IJF
GOKCEN Niyazi	TUR
KOWALSKI Marcin	POL
ZIVKOVIC Djordje	SRB
BERUASHVILI Mate	GEO
SKOMRLJ Roko	CRO
NAIRNE Ethan	GBR
HENRIKSSON Emil	SWE

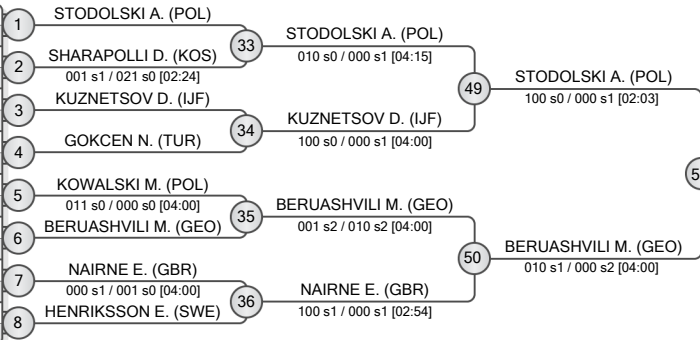

POOL B

MARASTONI Matthew Paul	ITA
RAHAMIM Ofek	ISR
ROSCA Serghei	MDA
KASRADZE Aleko	GEO
VELICKOVIC Bogdan	SRB
KUMTAS Soner	TUR
AKISHEV Nazar	UKR
BORZECKI Bartosz	POL
GOGINASHVILI Irakli	GBR
KURPEJOVIC Nijaz	MNE
HIMMELSPACH Yannick	GER

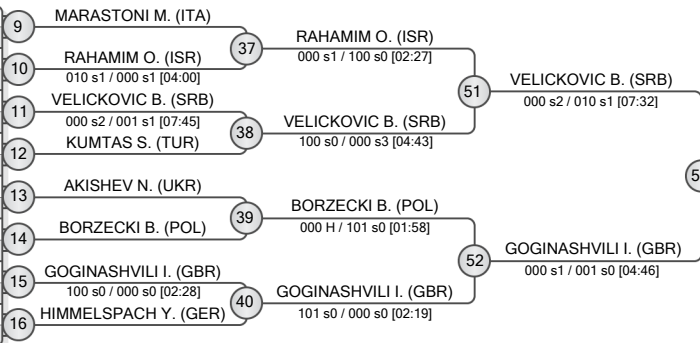

POOL C

SALVO Samuel	ITA
MAXLIN Miljohn	SWE
SEKNIJASVILI Tevdor	SRB
WANDTKE Viktor	GER
KALNINS Patriks	LAT
KATIC Luka	CRO
TOKTAY Ejder	TUR
PEC Jakub	POL
TADIC Luka	MNE
ZHEMUKHOV Marat	IJF

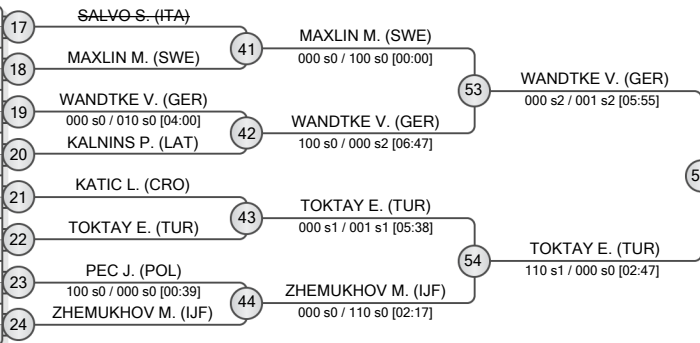

POOL D

LOSKA Olaf	POL
TURGUTLU Abdullah	TUR
JACKSON Thomas	GBR
MENZL Nikolas	GER
SENIC Mihailo	MNE
MITRU Vlad	MDA
KONING Ruben	NED
AYALON Ben	ISR
LOJANICIC Marko	SRB
BRUDETTI Luigi	ITA
MOSIASHVILI Tornike	GEO

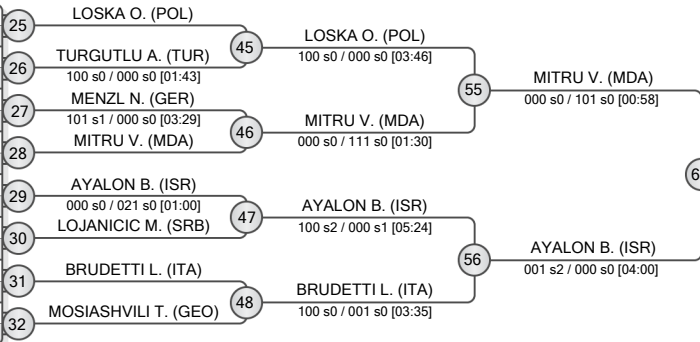

REPECHAGE

KOWALSKI M. (POL)	61
KURPEJOVIC N. (MNE)	62
HIMMELSPACH Y. (GER)	63
KATIC L. (CRO)	64
MENZL N. (GER)	65
NAIRNE E. (GBR)	66
BORZECKI B. (POL)	67
ZHEMUKHOV M. (IJF)	68
LOSKA O. (POL)	69
AYALON B. (ISR)	70
STODOLSKI A. (POL)	71
VELICKOVIC B. (SRB)	72
MITRU V. (MDA)	73
GOGINASHVILI I. (GBR)	74
BERUASHVILI M. (GEO)	75
VELICKOVIC B. (SRB)	76
MITRU V. (MDA)	77
ZHEMUKHOV M. (IJF)	78
GOGINASHVILI I. (GBR)	79

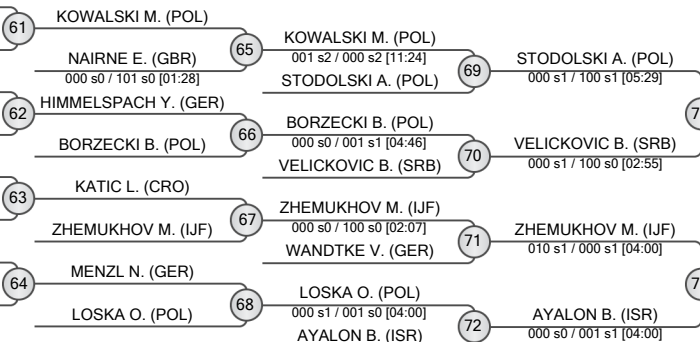

FINAL RESULTS	
1. TOKTAY Ejder	TUR
2. BERUASHVILI Mate	GEO
3. MITRU Vlad	MDA
3. GOGINASHVILI Irakli	GBR
5. VELICKOVIC Bogdan	SRB
5. ZHEMUKHOV Marat	IJF
7. STODOLSKI Adam	POL
7. AYALON Ben	ISR





Podgorica Senior European Cup 2025

Montenegro, Podgorica, 8-9 Mar 2025

-81 kg

Men (33)

POOL A

	GARDASEVIC Nebojsa	MNE	1	GARDASEVIC N. (MNE)
	VAN SINDEREN Mika	NED	2	VAN SINDEREN M. (NED)
	DREXLER Philip	GER	3	DREXLER P. (GER)
	KESHET HALEVI Ori	ISR	4	KESHET HALEVI O. (ISR)
	GUSIC Marko	MNE	5	GUSIC M. (MNE)
	LOLADZE Aleksandre	GEO	6	LOLADZE A. (GEO)
	THOMAS Peter	GER	7	THOMAS P. (GER)
	SIMSEK Musa	TUR	8	SIMSEK M. (TUR)

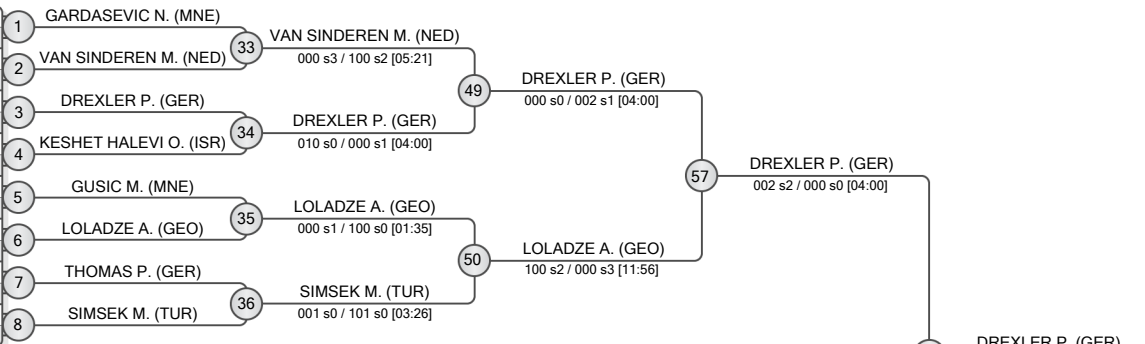

POOL B

	NOACK Gerrit	GER	9	NOACK G. (GER)
	PAJOVIC Petar	MNE	10	PAJOVIC P. (MNE)
	ZOROTOVIC Luka	CRO	11	ZOROTOVIC L. (CRO)
	ARI Emir Selim	TUR	12	ARI E. (TUR)
	MATTSSON Pelle	SWE	13	MATTSSON P. (SWE)
	GRIBINET Ciprian	MDA	14	GRIBINET C. (MDA)
	SADIKU Stevan	MNE	15	SADIKU S. (MNE)
	BUBALO Aleksa	SRB	16	BUBALO A. (SRB)

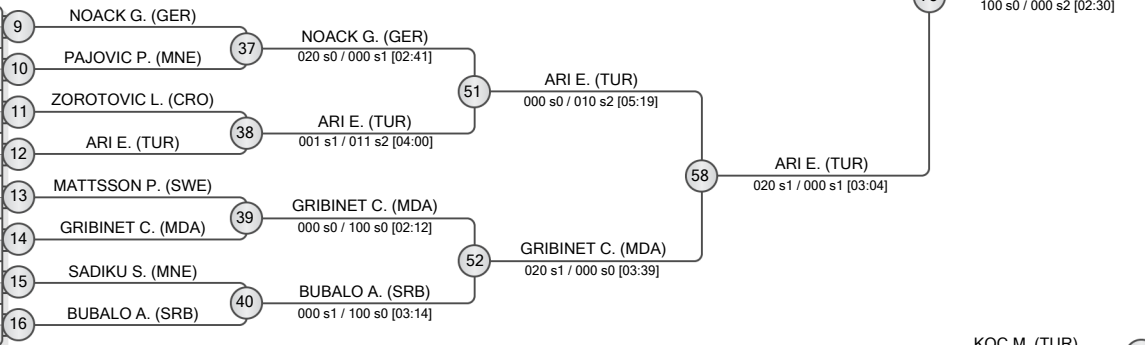

POOL C

	GARDASEVIC Nikola	MNE	17	GARDASEVIC N. (MNE)
	OHNEISER Lukas	GER	18	OHNEISER L. (GER)
	GURGEN Erman	TUR	19	MECILOSEK J. (SLO)
	MECILOSEK Jus	SLO	20	MECILOSEK J. (SLO)
	YAKOVLEV David	ISR	21	YAKOVLEV D. (ISR)
	ELEZ Vuk	SRB	22	ELEZ V. (SRB)
	BEGIC Ante Ivan	CRO	23	BEGIC A. (CRO)
	LEHNIGER Joseph	GER	24	LEHNIGER J. (GER)
	NURKOVIC Jahja	MNE	24	NURKOVIC J. (MNE)

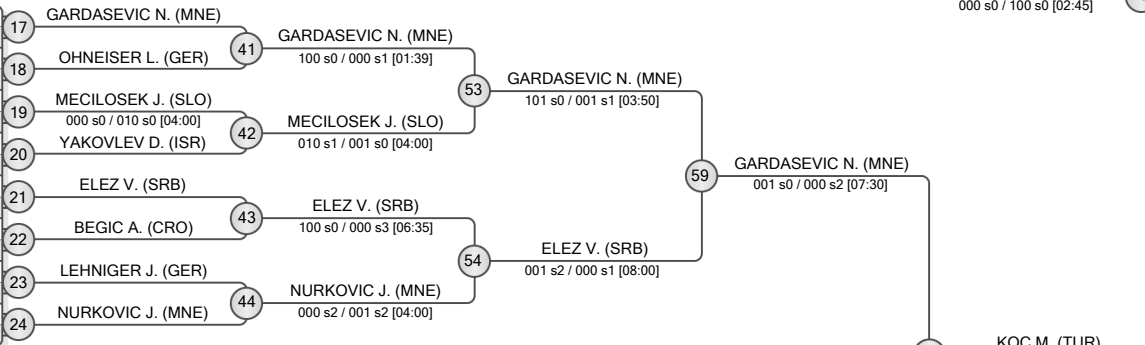

POOL D

	KAUN Sebastian	GER	25	KAUN S. (GER)
	DEMIREL Umalt	TUR	26	DEMIREL U. (TUR)
	RAKOCEVIC Marko	MNE	27	RAKOCEVIC M. (MNE)
	LOEBER Inno	NED	28	LOEBER I. (NED)
	STANIMIROVIC Vukan	SRB	29	STANIMIROVIC V. (SRB)
	POLAK Ori	ISR	30	POLAK O. (ISR)
	KOC Muhammed	TUR	31	KOC M. (TUR)
	ALIAMKIN Sergei	IJF	32	ALIAMKIN S. (IJF)

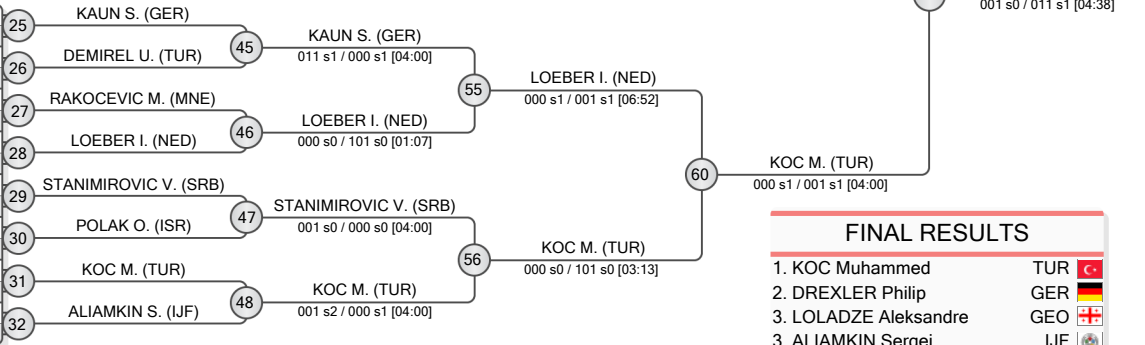

FINAL RESULTS		
1.	KOC Muhammed	TUR
2.	DREXLER Philip	GER
3.	LOLADZE Aleksandre	GEO
3.	ALIAMKIN Sergei	IJF
5.	GARDASEVIC Nikola	MNE
5.	ARI Emir Selim	TUR
7.	GRIBINET Ciprian	MDA
7.	MECILOSEK Jus	SLO

REPECHAGE

KESHET HALEVI O. (ISR)	61	KESHET HALEVI O. (ISR)	65	VAN SINDEREN M. (NED)
ZOROTOVIC L. (CRO)	62	ZOROTOVIC L. (CRO)	66	NOACK G. (GER)
OHNEISER L. (GER)	63	OHNEISER L. (GER)	67	MECILOSEK J. (SLO)
ALIAMKIN S. (IJF)	64	ALIAMKIN S. (IJF)	68	STANIMIROVIC V. (SRB)

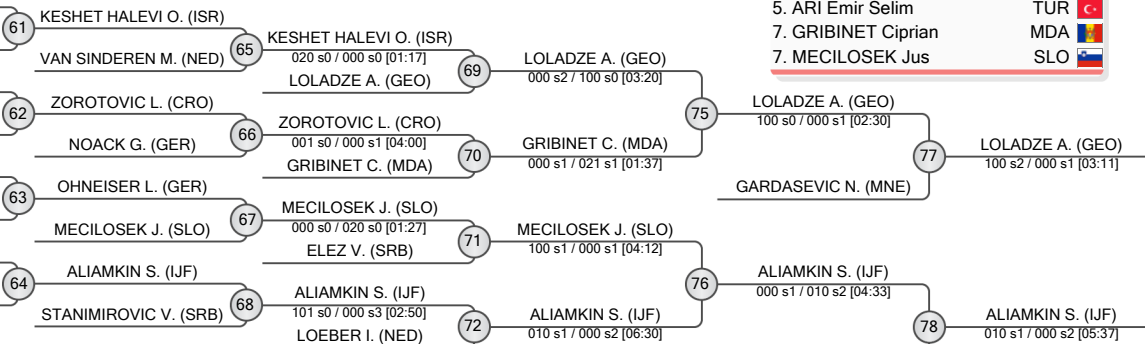



Podgorica Senior European Cup 2025

Montenegro, Podgorica, 8-9 Mar 2025

-90 kg

Men (32)

POOL A

	PETGRAVE Jamal	GBR	1
	ABAZOV Astemir	IJF	2
	SERHIICHUK Stanislav	UKR	3
	SCEPANOVIC Balsa	MNE	4
	HEDENBLAD Joel	SWE	5
	KOSTIC Scepán	MNE	6
	VESELI Anes	KOS	7
	KOMPE Mertcan	TUR	8

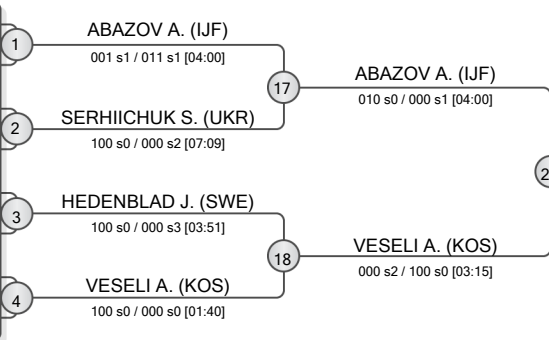

POOL B

	DE BRUIN Jelle	NED	5
	WASIKOWSKI Michal	POL	6
	RIEDEL Louis	GER	7
	SUFAJ Ardian	CRO	8
	RAICEVIC Novo	MNE	9
	EL ASHI Hedar Ihab	BUL	10
	JOVANOVIC Marko	SRB	11
	GUZEL Can	TUR	12

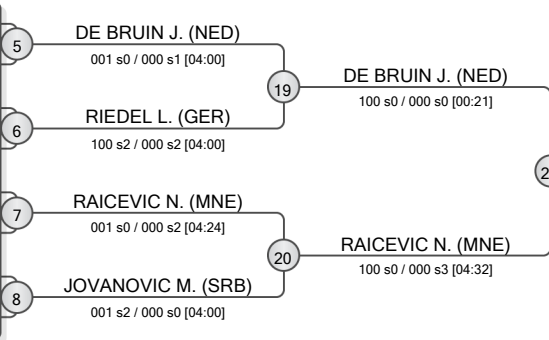

POOL C

	MANDIC Vojin	SRB	9
	PANAGIOTOPOULOS Ioannis	GRE	10
	GUSIC Nikola	MNE	11
	MAKAROVIC Oliver	CRO	12
	NIKCEVIC Stevan	MNE	13
	PINAR Enes	TUR	14
	SCHREDER Leon	GER	15
	KUNIZHEV Rolan	IJF	16

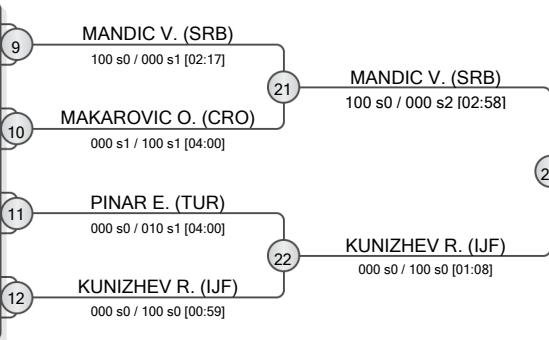

POOL D

	PANKOWSKI Jakub	POL	13
	RUTOVIC Boris	SRB	14
	DJURISIC Andrija	MNE	15
	REZNIKOV Roman	IJF	16
	HYTONEN Leonidas	SWE	17
	CUHADAR Ahmet	TUR	18
	MITROVIC Aleksa	FRA	19
	KONCILIIJA Dan	CRO	20

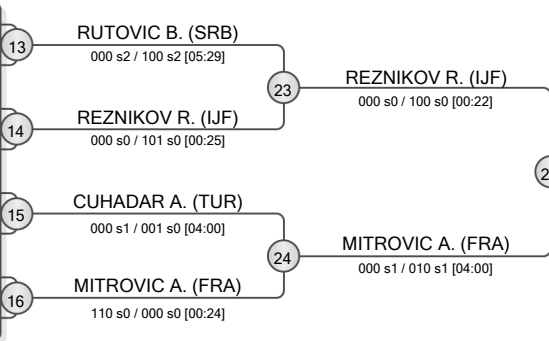

FINAL RESULTS	
1.	KUNIZHEV Rolan IJF
2.	RAICEVIC Novo MNE
3.	PETGRAVE Jamal GBR
4.	MANDIC Vojin SRB
5.	REZNIKOV Roman IJF
6.	ABAZOV Astemir IJF
7.	JOVANOVIC Marko SRB
8.	MITROVIC Aleksa FRA

REPECHAGE

PETGRAVE J. (GBR)	29	PETGRAVE J. (GBR)	30	JOVANOVIC M. (SRB)	31	SCHREDER L. (GER)	32	RUTOVIC B. (SRB)
SERHIICHUK S. (UKR)		VESELI A. (KOS)		DE BRUIN J. (NED)		PINAR E. (TUR)		MITROVIC A. (FRA)
EL ASHI H. (BUL)						DJURISIC A. (MNE)		
JOVANOVIC M. (SRB)								
SCHREDER L. (GER)								
PINAR E. (TUR)								
DJURISIC A. (MNE)								
RUTOVIC B. (SRB)								

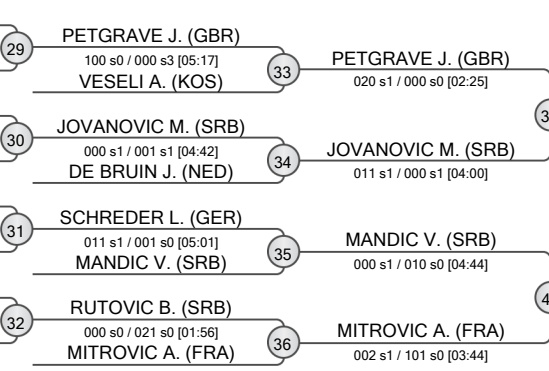



Podgorica Senior European Cup 2025

Montenegro, Podgorica, 8-9 Mar 2025

+100 kg

Men (16)

POOL A

	BRONIEC Patryk	POL
	ZOLOTUKHIN Artem	IJF
	ERGIN Recep	TUR
	MARAS Danilo	MNE

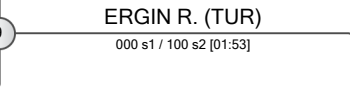
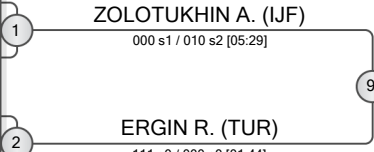

POOL B

	VUKIC Slobodan	MNE
	CSEKASZOV Mihaly	HUN
	STOSIC Andrija	SRB
	DUBRETA Anto	MNE

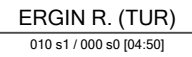
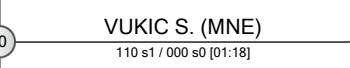
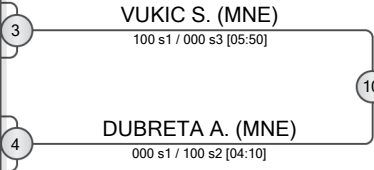

POOL C

	KARDAVA Saba	GEO
	PEROVIC Jovan	MNE
	ANDJELIC Nemanja	MNE
	TUTAR Tunahan	TUR

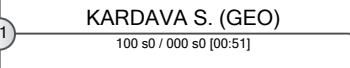
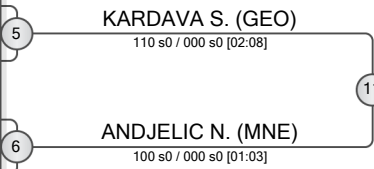

POOL D

	SORDYL Jakub	POL
	CUPIC Lazar	MNE
	GREENIDGE Wesley	GBR
	JASEK Vaclav	CZE

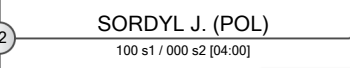
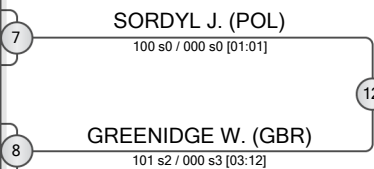

FINAL RESULTS		
1.	ERGIN Recep	TUR
2.	KARDAVA Saba	GEO
3.	ZOLOTUKHIN Artem	IJF
3.	GREENIDGE Wesley	GBR
5.	SORDYL Jakub	POL
5.	VUKIC Slobodan	MNE
7.	DUBRETA Anto	MNE
7.	PEROVIC Jovan	MNE

REPECHAGE

MARAS D. (MNE)	
ZOLOTUKHIN A. (IJF)	13
CSEKASZOV M. (HUN)	
DUBRETA A. (MNE)	14
PEROVIC J. (MNE)	
ANDJELIC N. (MNE)	15
CUPIC L. (MNE)	
GREENIDGE W. (GBR)	16

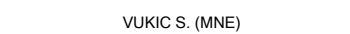
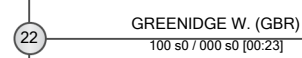
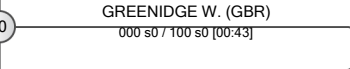
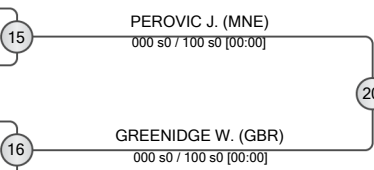
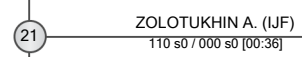
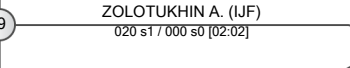
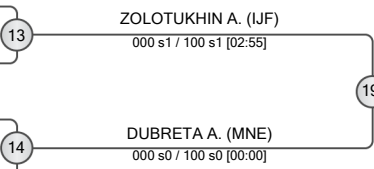



Podgorica Senior European Cup 2025

Montenegro, Podgorica, 8-9 Mar 2025

-48 kg

Women (12)

POOL A

	MOISEEVA Aina	IJF
	CANDAN Emine Ikra	TUR
	RANGELOVA Sofia	BUL

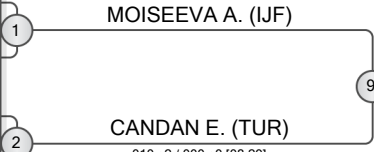

POOL B

	WOZNIAK Zuzanna	POL
	PROLIC Natalija	SRB
	FROBENIUS Hannah	GER

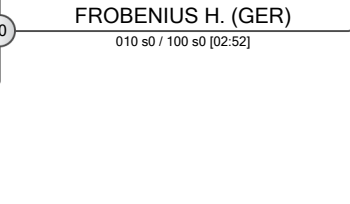
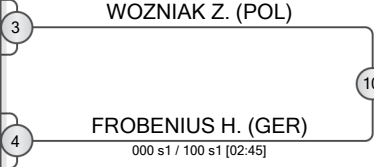

POOL C

	SZLACHTA Paulina	POL
	HASLER Leah	GBR
	ARIFAJ Estea	KOS

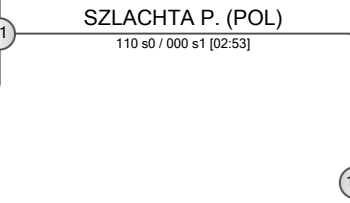
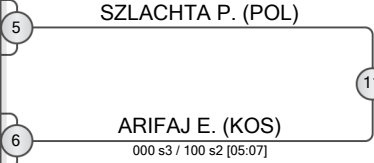

POOL D

	SCHNEIDER Anja	GER
	KIRT Elif	TUR
	IOVINO Anna	ITA

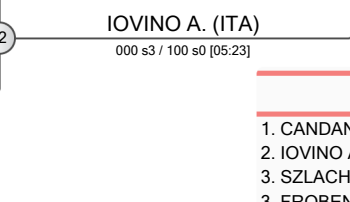
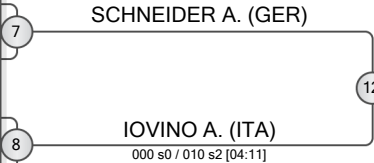

REPECHAGE

RANGELOVA S. (BUL)	13	MOISEEVA A. (IJF) 000 s3 / 100 s2 [03:31]
MOISEEVA A. (IJF)	14	PROLIC N. (SRB) 100 s2 / 000 s1 [03:09]
PROLIC N. (SRB)	15	ARIFAJ E. (KOS) 100 s2 / 000 s1 [03:09]
WOZNIAK Z. (POL)	16	KIRT E. (TUR) 100 s2 / 000 s1 [03:09]
ARIFAJ E. (KOS)		
KIRT E. (TUR)		
SCHNEIDER A. (GER)		

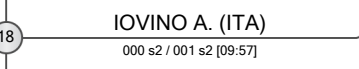
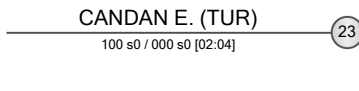
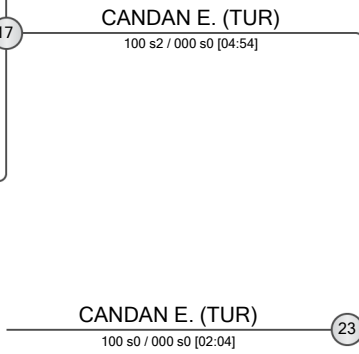
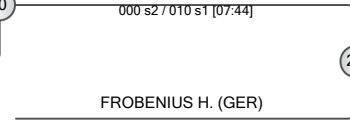
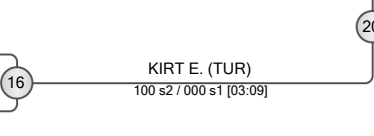
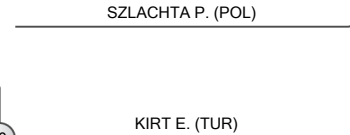
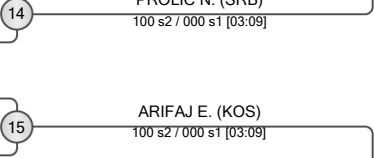
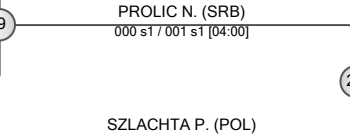
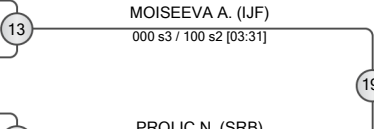

FINAL RESULTS

1.	CANDAN Emine Ikra	TUR	
2.	IOVINO Anna	ITA	
3.	SZLACHTA Paulina	POL	
3.	FROBENIUS Hannah	GER	
5.	PROLIC Natalija	SRB	
5.	KIRT Elif	TUR	
7.	MOISEEVA Aina	IJF	
7.	ARIFAJ Estea	KOS	





Podgorica Senior European Cup 2025

Montenegro, Podgorica, 8-9 Mar 2025

-52 kg

Women (11)

POOL A

	KALETA Aleksandra	POL
	KOMURCU Yaren	TUR
	SVECNJAK Matea	CRO

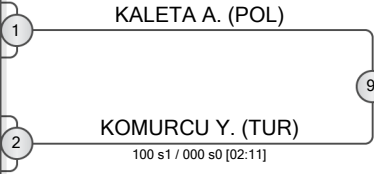

KOMURCU Y. (TUR)
000 s1 / 001 s0 [05:24]

POOL B

	GEORGIEVA Aleksa	BUL
	STEVANOVIC Milana	MNE

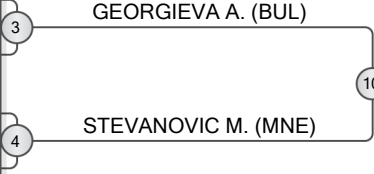

GEORGIEVA A. (BUL)
100 s0 / 000 s0 [01:05]

GEORGIEVA A. (BUL)
000 s1 / 001 s1 [04:00]

POOL C

	CIESLIK Klaudia	POL
	OSMANI Sara	KOS
	KARABULUT Buketnur	TUR

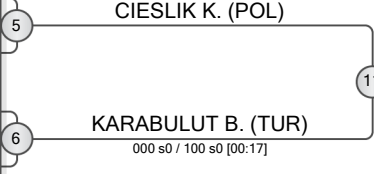

KARABULUT B. (TUR)
000 s0 / 100 s0 [00:23]

KARABULUT B. (TUR)
001 s0 / 010 s1 [04:00]

POOL D

	DJERIOU Lena	GER
	KLIMCZAK Kinga	POL
	SULUN Ayse Nur	TUR

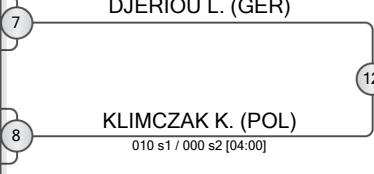

DJERIOU L. (GER)
020 s0 / 000 s1 [03:56]

KARABULUT B. (TUR)
100 s0 / 000 s0 [02:11]

REPECHAGE

SVECNJAK M. (CRO)	13
KALETA A. (POL)	14
STEVANOVIC M. (MNE)	15
OSMANI S. (KOS)	16
CIESLIK K. (POL)	17
KLIMCZAK K. (POL)	18

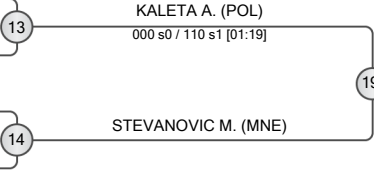

KALETA A. (POL)
020 s0 / 000 s0 [00:33]

KALETA A. (POL)
101 s0 / 000 s0 [01:00]

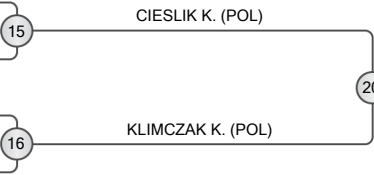

KLIMCZAK K. (POL)
000 s0 / 100 s0 [00:00]

KLIMCZAK K. (POL)
100 s0 / 000 s0 [01:38]

KOMURCU Y. (TUR)

FINAL RESULTS

1. KARABULUT Buketnur	TUR	
2. GEORGIEVA Aleksa	BUL	
3. KALETA Aleksandra	POL	
3. KLIMCZAK Kinga	POL	
5. DJERIOU Lena	GER	
5. KOMURCU Yaren	TUR	
7. CIESLIK Klaudia	POL	





Podgorica Senior European Cup 2025

Montenegro, Podgorica, 8-9 Mar 2025

-57 kg

Women (11)

POOL A

	GARDASEVIC Tamara	MNE
	GRAMATIKOVA Snezhana	BUL
	OZDEMIR Ayse Naz	TUR

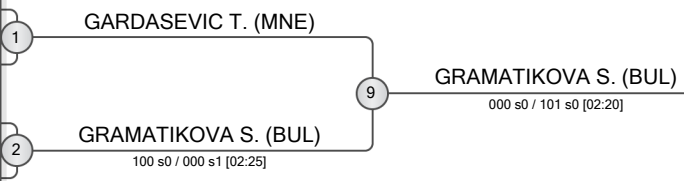

POOL B

	BUDAK Aysenur	TUR
	BULANDA Julia	POL
	SALKARBEK KIZI Dilbara	SRB

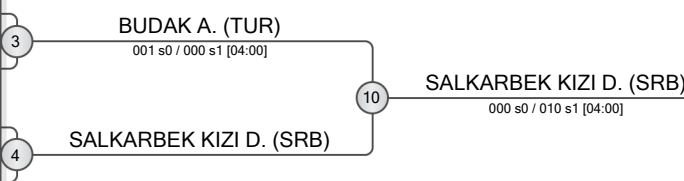

POOL C

	WYSS Lea	LIE
	BOZINOVIC Mia	MNE
	KARADAG Aysenur	TUR

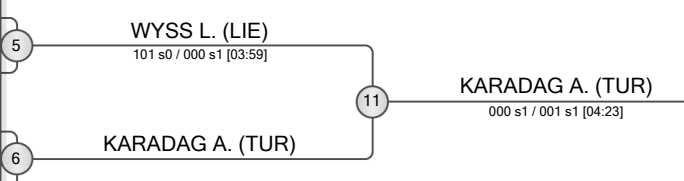

POOL D

	SIENNICKA Karolina	POL
	BJOERAAS Elise	NOR

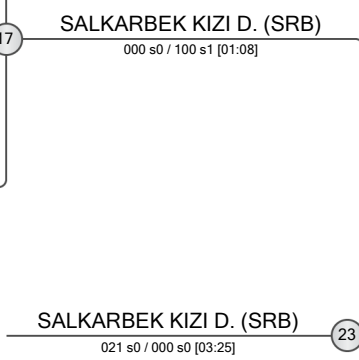
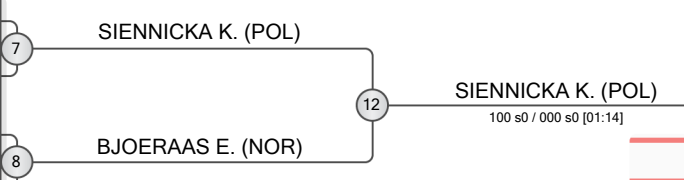

REPECHAGE

OZDEMIR A. (TUR)	13
GARDASEVIC T. (MNE)	14
BUDAK A. (TUR)	15
WYSS L. (LIE)	16
BJOERAAS E. (NOR)	17

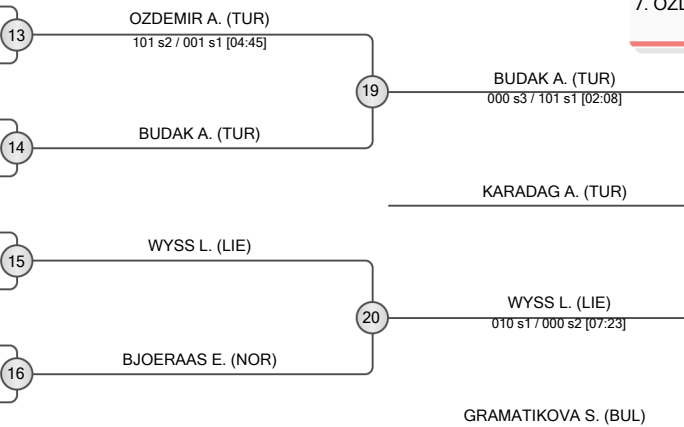

FINAL RESULTS		
1.	SALKARBEK KIZI Dilbara	SRB
2.	SIENNICKA Karolina	POL
3.	BUDAK Aysenur	TUR
3.	GRAMATIKOVA Snezhana	BUL
5.	KARADAG Aysenur	TUR
5.	WYSS Lea	LIE
7.	OZDEMIR Ayse Naz	TUR





Podgorica Senior European Cup 2025

Montenegro, Podgorica, 8-9 Mar 2025

-63 kg

Women (19)

POOL A

	AKDENIZ Minel	TUR	1	AKDENIZ M. (TUR)
	ANDERSSON Ella	SWE	2	GJAKOVA D. (KOS)
	GJAKOVA Debora	KOS	2	000 s2 / 100 s1 [02:56]
	SZAFRAN Agata	POL	3	SZAFRAN A. (POL)
	NURKOVIC Aisa	MNE	4	NURKOVIC A. (MNE)

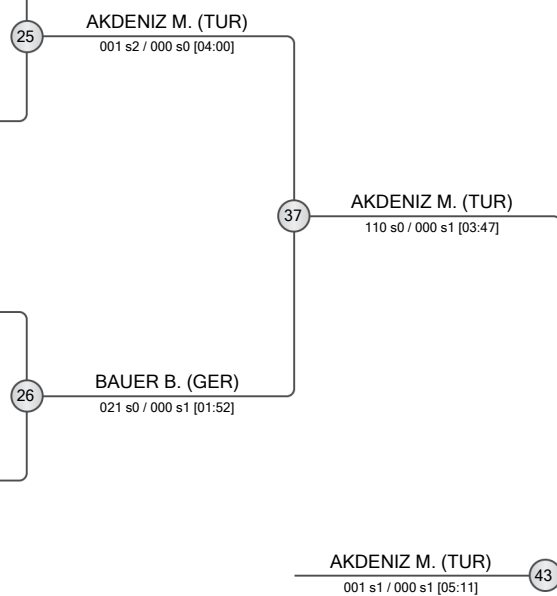
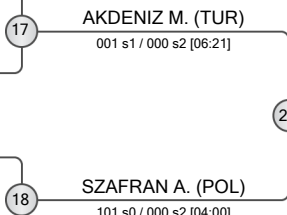

POOL B

	BAUER Bettina	GER	5	BAUER B. (GER)
	MARTINOVIC Mirjana	MNE	6	MARTINOVIC M. (MNE)
	IMERI Sara	CRO	6	100 s2 / 011 s1 [04:00]
	LAUBER Natascha	GER	7	LAUBER N. (GER)
	VATANSEVER Ceyda	TUR	8	VATANSEVER C. (TUR)

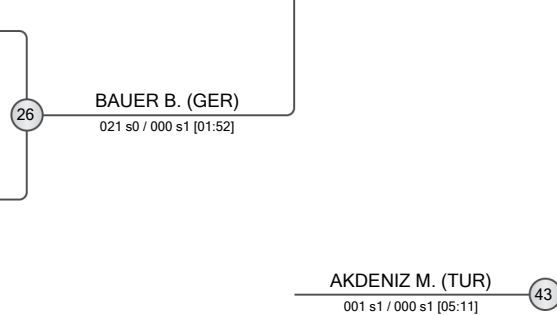
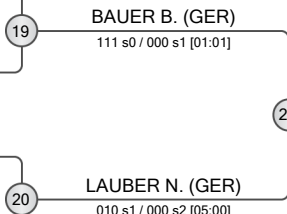

POOL C

	VON LEUPOLDT Charlotte	GER	9	VON LEUPOLDT C. (GER)
	JEFTIC Natasa	MNE	10	MINKINA E. (IJF)
	MINKINA Ekaterina	IJF	10	000 s0 / 100 s0 [01:25]
	TCACI Daniela	MDA	11	TCACI D. (MDA)
	KARADEMIR Ezgi	TUR	12	KARADEMIR E. (TUR)

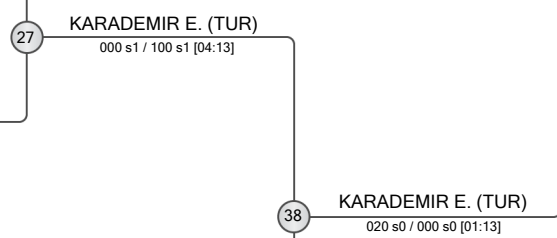
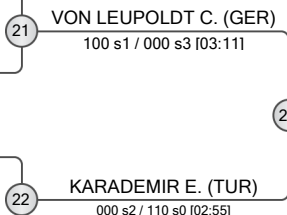

POOL D

	LISCIANI Sara	ITA	13	LISCIANI S. (ITA)
	LAURITSEN Isabella	DEN	14	LAURITSEN I. (DEN)
	OSTLIND Gretha	SWE	15	OSTLIND G. (SWE)
	BERR Sonja Michelle	GER	16	BERR S. (GER)

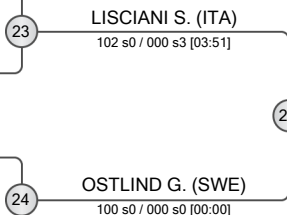

FINAL RESULTS		
1.	AKDENIZ Minel	TUR
2.	KARADEMIR Ezgi	TUR
3.	LISCIANI Sara	ITA
3.	BAUER Bettina	GER
5.	SZAFRAN Agata	POL
7.	TCACI Daniela	MDA
7.	LAUBER Natascha	GER
7.	LAURITSEN Isabella	DEN

REPECHAGE

GJAKOVA D. (KOS)	29	GJAKOVA D. (KOS)	SZAFRAN A. (POL)	33	001 s0 / 101 s1 [03:12]
MARTINOVIC M. (MNE)	30	MARTINOVIC M. (MNE)	LAUBER N. (GER)	34	000 s3 / 110 s0 [03:49]
TCACI D. (MDA)	31	TCACI D. (MDA)	VON LEUPOLDT C. (GER)	35	100 s1 / 000 s0 [01:51]
LAURITSEN I. (DEN)	32	LAURITSEN I. (DEN)	LAURITSEN I. (DEN)	36	100 s1 / 000 s3 [06:30]

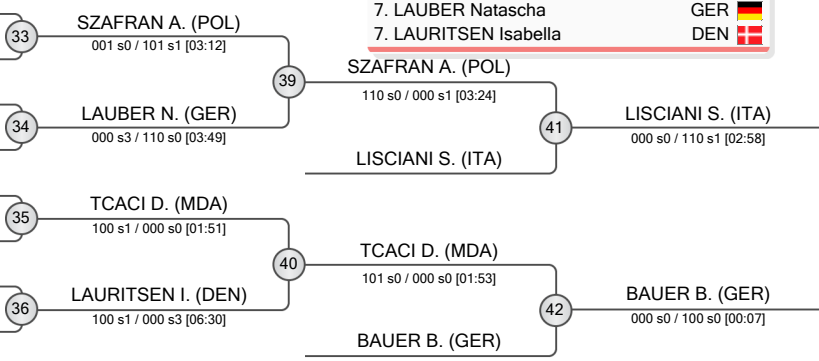



Podgorica Senior European Cup 2025

Montenegro, Podgorica, 8-9 Mar 2025

-70 kg

Women (17)

POOL A

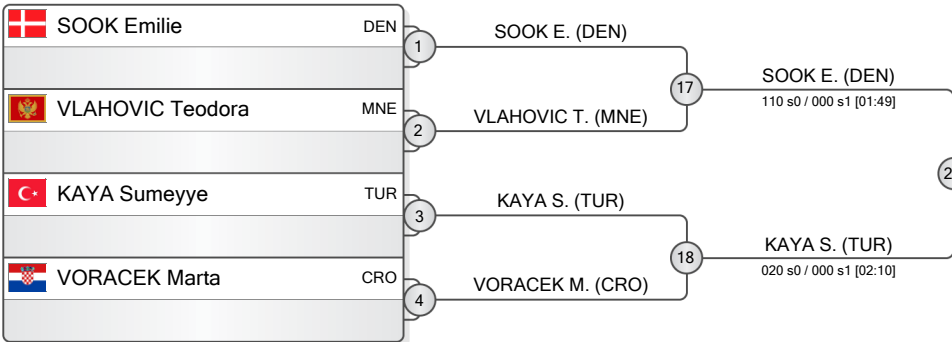

POOL B

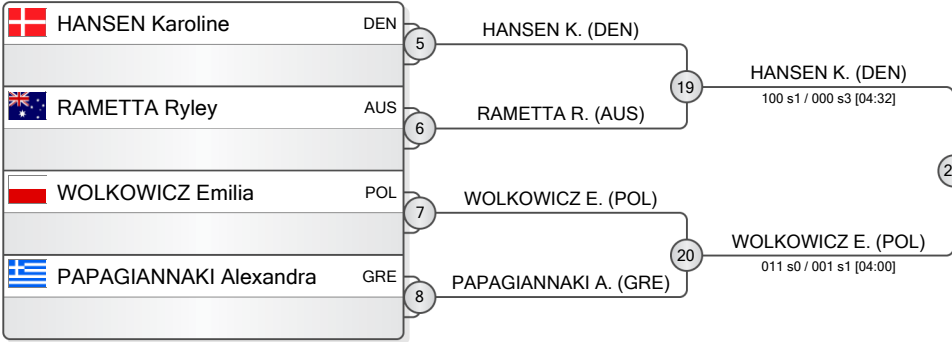

POOL C

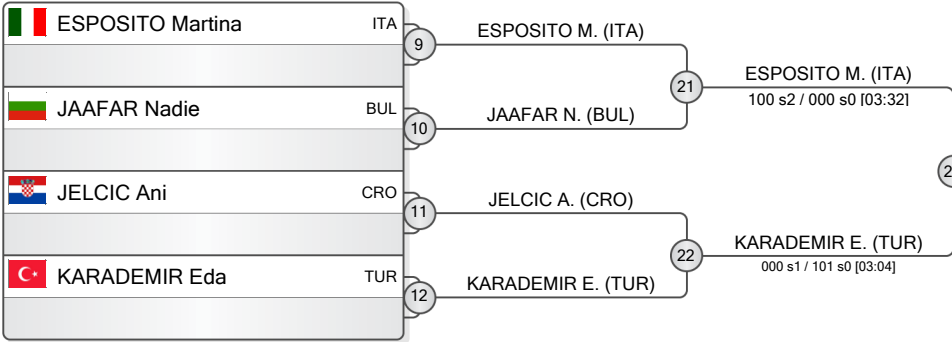

POOL D

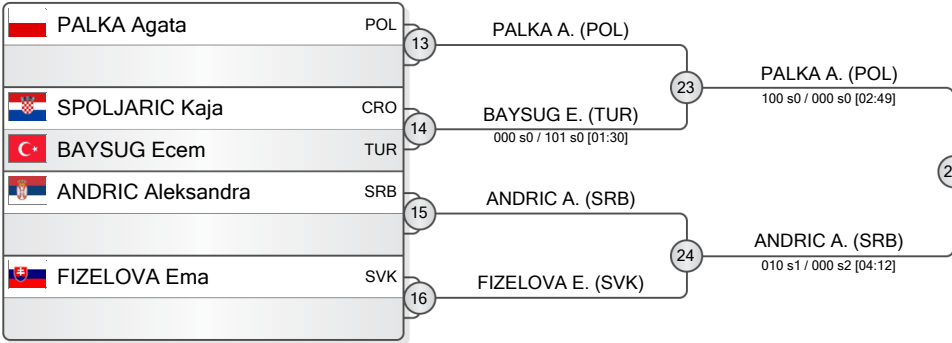

REPECHAGE

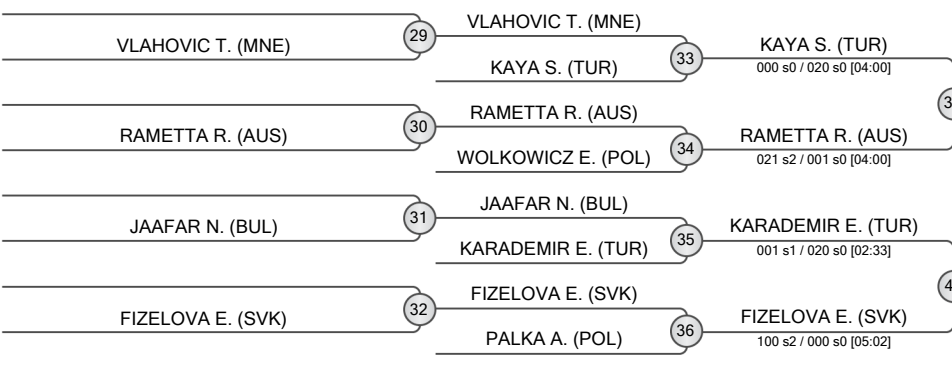

43. ANDRIC A. (SRB) 000 s1 / 100 s0 [02:41]

38. ANDRIC A. (SRB) 000 s0 / 100 s0 [00:48]

FINAL RESULTS

1. ANDRIC Aleksandra SRB
2. SOOK Emilie DEN
3. ESPOSITO Martina ITA
3. FIZELOVA Ema SVK
5. KAYA Sumeyye TUR
5. HANSEN Karoline DEN
7. RAMETTA Ryley AUS
7. KARADEMIR Eda TUR





Podgorica Senior European Cup 2025

Montenegro, Podgorica, 8-9 Mar 2025

-78 kg

Women (11)

POOL A

	GOBEC Lea	CRO
	AGAC Gulsum	TUR
	IUDINA Polina	IJF



POOL B

	CHOBOT Klaudia	POL
	KOCABEY Ceylan	TUR

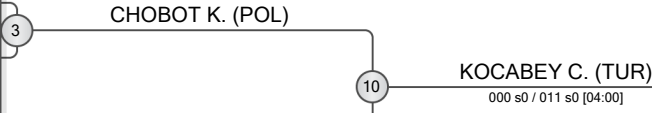

POOL C

	MUSZYNSKA Paulina	POL
	POGACNIK Anka	SLO
	CICEK Seyda Nur	TUR

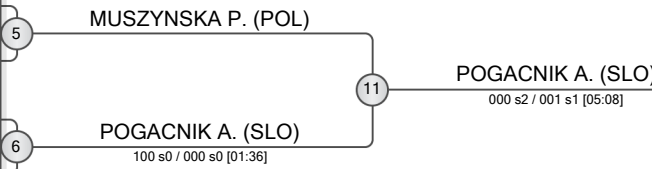

POOL D

	HORES Tali	ISR
	VULPASIN Maria-Nicoleta	GRE
	VANDEMIR Hatice	TUR

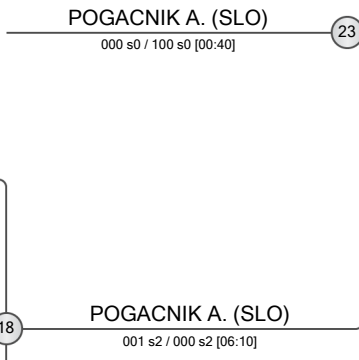
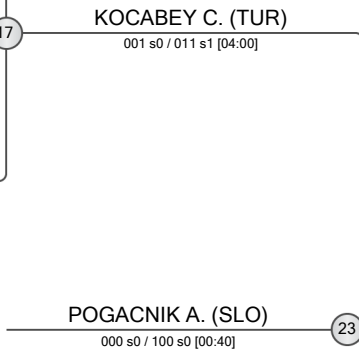
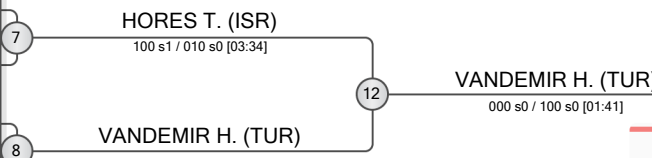

REPECHAGE

AGAC G. (TUR)	13
GOBEC L. (CRO)	14
CHOBOT K. (POL)	15
CICEK S. (TUR)	16
MUSZYNSKA P. (POL)	17
HORES T. (ISR)	18

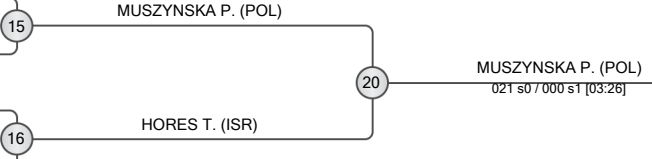
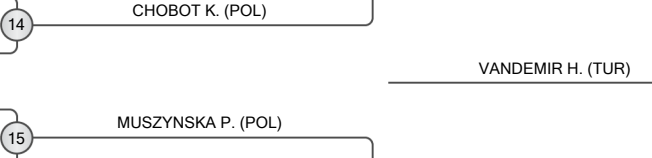
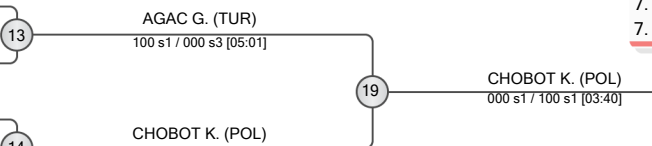

FINAL RESULTS

1. POGACNIK Anka	SLO	
2. KOCABEY Ceylan	TUR	
3. VANDEMIR Hatice	TUR	
3. MUSZYNSKA Paulina	POL	
5. CHOBOT Klaudia	POL	
5. IUDINA Polina	IJF	
7. AGAC Gulsum	TUR	
7. HORES Tali	ISR	





Podgorica Senior European Cup 2025

Montenegro, Podgorica, 8-9 Mar 2025

+78 kg

Women (12)

POOL A

	WOLSZCZAK Kinga	POL
	ESIR Kubranur	TUR
	ORLOVIC Katarina	SRB

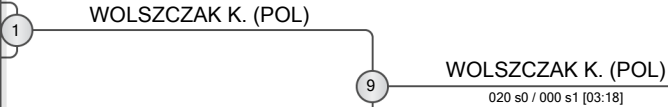

POOL B

	KUESTER Amani	GER
	JANJIC Tara	SLO
	METE Sema	TUR

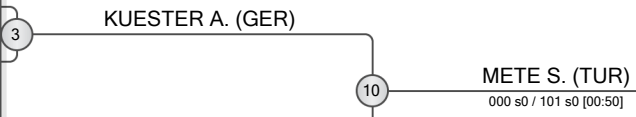

POOL C

	HOFMAN Urszula	POL
	ZHELEZARSKA Irina	BUL
	YILMAZ Yagmur	TUR

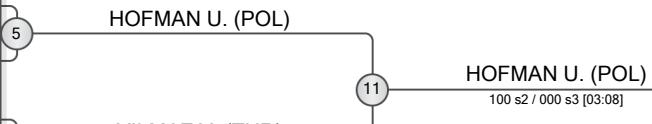

POOL D

	MARANIC Ivana	CRO
	MRVALJEVIC Jovana	MNE
	GONSIOR Emilia	POL

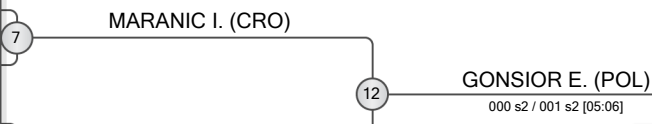

REPECHAGE

13	ESIR K. (TUR)
14	KUESTER A. (GER)
15	YILMAZ Y. (TUR)
16	MARANIC I. (CRO)

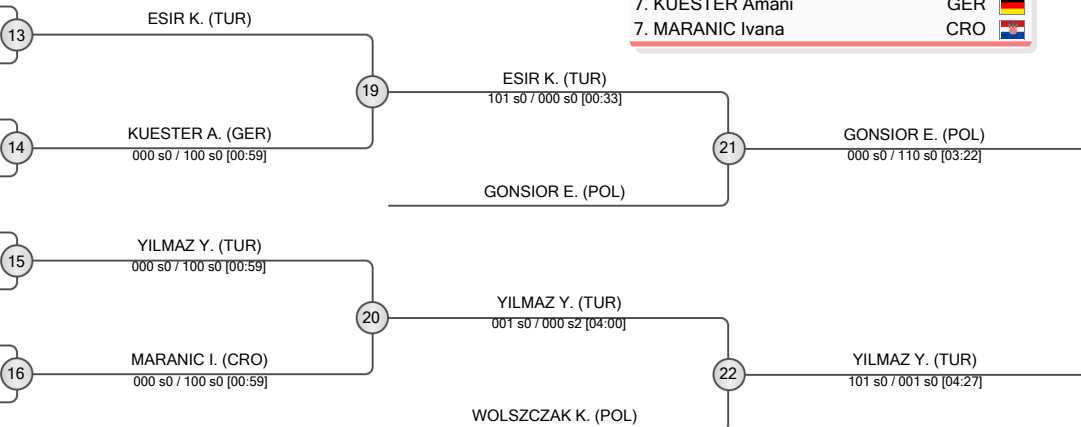

FINAL RESULTS		
1.	HOFMAN Urszula	POL
2.	METE Sema	TUR
3.	GONSIOR Emilia	POL
4.	YILMAZ Yagmur	TUR
5.	ESIR Kubranur	TUR
6.	WOLSZCZAK Kinga	POL
7.	KUESTER Amani	GER
8.	MARANIC Ivana	CRO

