



Faro Millennium Team Cadet European Cup 2026

Portugal, Faro/Algarve, 23-24 May 2026

-50 kg

Cadets (36)

POOL A

BONATO Arthur	BRA	1	BONATO A. (BRA)
MIDRIGAN Bogdan	MDA	2	MIDRIGAN B. (MDA)
NGUYEN Gia Vinh	FRA	3	LOPEZ PEREIRA H. (ESP)
LOPEZ PEREIRA Hugo	ESP	33	LOPEZ PEREIRA H. (ESP)
LATTANZI Mattia	ITA	4	LATTANZI M. (ITA)
MARKOVICS Adam	SVK	5	MARKOVICS A. (SVK)
FONMARTIN Bastien	FRA	6	FONMARTIN B. (FRA)
AMADIO Kevin	ITA	7	AMADIO K. (ITA)
SOLER VELASCO Adrian	ESP	8	SOLER VELASCO A. (ESP)

POOL B

KOZAK Matus	SVK	9	KOZAK M. (SVK)
PALHINHA Guilherme	POR	10	PALHINHA G. (POR)
BELKOUK Walid	FRA	11	BELKOUK W. (FRA)
LONGOBARDI Gabriel	ITA	12	LONGOBARDI G. (ITA)
LATTANZI Ruben	ITA	13	LATTANZI R. (ITA)
TRISBERG Ravo	EST	14	BERNUZ H. (FRA)
BERNUZ Hugo	FRA	15	ALVAREZ MORA D. (ESP)
ALVAREZ MORA Daniel	ESP	15	ALVAREZ MORA D. (ESP)
FASTUCA Andrea	ITA	16	FASTUCA A. (ITA)

POOL C

MEHABRA Ismael	ITA	17	MEHABRA I. (ITA)
RUIZ BLASCO Santiago	ESP	18	RUIZ BLASCO S. (ESP)
COME Erwann	FRA	19	QUINTINO A. (POR)
QUINTINO Armando	POR	20	QUINTINO A. (POR)
MOUSSAID Mehdi	BEL	20	MOUSSAID M. (BEL)
ZUBETS Rodion	EST	21	ZUBETS R. (EST)
LO VERSO Giulio	ITA	22	LO VERSO G. (ITA)
CERRILLO LOPEZ Mateo	ESP	23	CERRILLO LOPEZ M. (ESP)
ZANELLA Emrick	FRA	24	ZANELLA E. (FRA)

POOL D

ANTONACCI Sebastiano Gabriele	ITA	25	ANTONACCI S. (ITA)
DE NANTES Octave	FRA	26	DE NANTES O. (FRA)
MARTINELLI Massimo	ITA	27	MARTINELLI M. (ITA)
POLO LAGUNA Simon	ESP	28	POLO LAGUNA S. (ESP)
YAGUE LANCH A Ruben	ESP	29	YAGUE LANCH A R. (ESP)
KJOLNER Caspian	NOR	30	ALVES A. (POR)
ALVES Andre Henrique	POR	30	ALVES A. (POR)
PELLICCIA Diego Fabrizio	ITA	31	PELLICCIA D. (ITA)
MORIN Lucas	FRA	32	MORIN L. (FRA)

REPECHAGE

NGUYEN G. (FRA)	61	LATTANZI M. (ITA)	61	LATTANZI M. (ITA)
LATTANZI M. (ITA)	62	BONATO A. (BRA)	65	BONATO A. (BRA)
PALHINHA G. (POR)	62	BONATO A. (BRA)	65	BONATO A. (BRA)
RUIZ BLASCO S. (ESP)	63	AMADIO K. (ITA)	69	BONATO A. (BRA)
PELLICCIA D. (ITA)	64	BELKOUK W. (FRA)	70	BELKOUK W. (FRA)
		BELKOUK W. (FRA)	70	BELKOUK W. (FRA)
		ALVAREZ MORA D. (ESP)	70	BELKOUK W. (FRA)
		QUINTINO A. (POR)	67	QUINTINO A. (POR)
		QUINTINO A. (POR)	67	QUINTINO A. (POR)
		ZANELLA E. (FRA)	71	ZANELLA E. (FRA)
		ZANELLA E. (FRA)	71	ZANELLA E. (FRA)
		YAGUE LANCH A R. (ESP)	68	YAGUE LANCH A R. (ESP)
		YAGUE LANCH A R. (ESP)	68	YAGUE LANCH A R. (ESP)
		MARTINELLI M. (ITA)	72	MARTINELLI M. (ITA)
		MARTINELLI M. (ITA)	72	MARTINELLI M. (ITA)

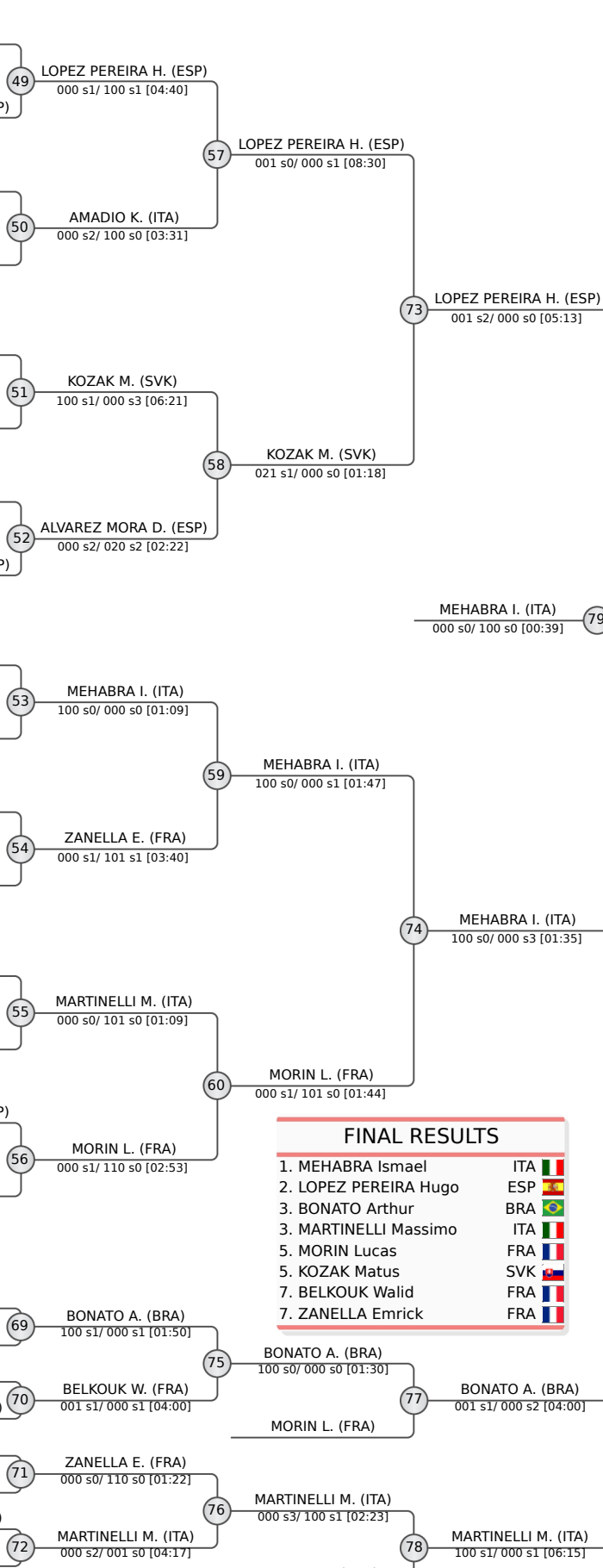

FINAL RESULTS		
1.	MEHABRA Ismael	ITA
2.	LOPEZ PEREIRA Hugo	ESP
3.	BONATO Arthur	BRA
3.	MARTINELLI Massimo	ITA
5.	MORIN Lucas	FRA
7.	BELKOUK Walid	FRA
7.	ZANELLA Emrick	FRA



Faro Millennium Team Cadet European Cup 2026

Portugal, Faro/Algarve, 23-24 May 2026

-55 kg

Cadets (48)

POOL A

MALIC Nelu	MDA	1
VUSHEV Aleksandar	BUL	2
MARCHESI Matteo	ITA	3
ASPROIU George	ROU	4
ROTH Sasha	FRA	5
RUIZ SANTOS Adrian	ESP	6
MARCHIORI Ugo	LUX	7
SOARES Diogo	POR	8
CALVO SANCHEZ Ivan	ESP	9
DI NATALE Andrea	ITA	10
SANTOS Joao Pedro	BRA	11
BURGUILLO MATEO David	ESP	12

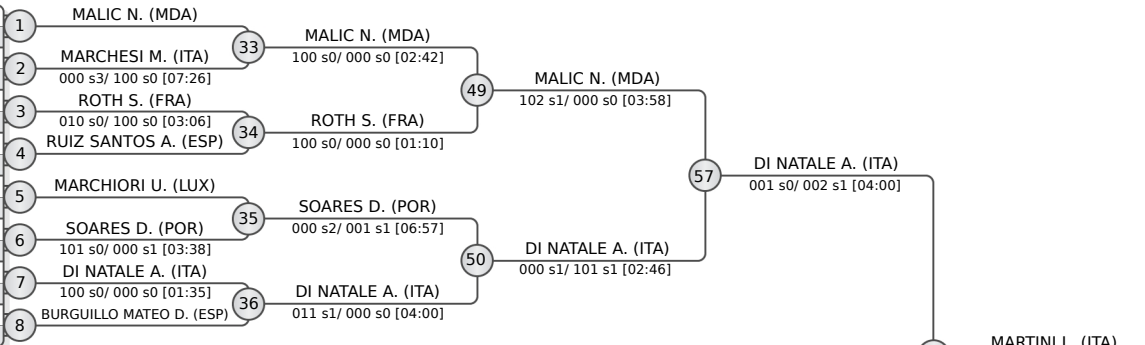

POOL B

MARTINI Luca	ITA	13
HILARIO Rodrigo	POR	14
MENDES Enzo	FRA	15
TURCANU Alvian	MDA	16
TERRAMEA Francesco	ITA	17
GALLARDO CRUZ Alvaro	ESP	18
DOUINE Matteo	ITA	19
NGUYEN Doan	FRA	20
ECHANIZ RIOS Yerai	ESP	21
FONTES Marcio	BRA	22
AMARAL Joao	POR	23
RHODES Lewis	GBR	24

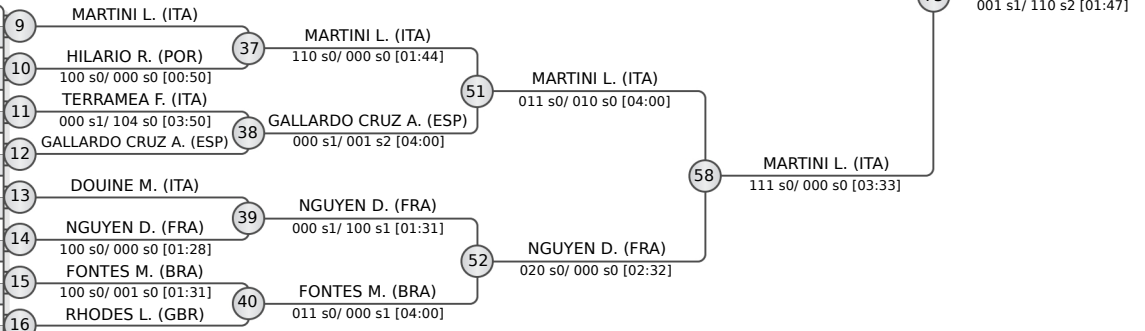

POOL C

IGLESIAS-RODRIGUEZ Matthew	PUR	25
PERROTTA Leonardo	ITA	26
SAAR Kou Lennart	EST	27
LEGER VILLA Lucien	FRA	28
FUENTE VIZOSO Alex	ESP	29
SERAFINI Samuel	ITA	30
PETROSINO Errico	ITA	31
LEMONS RODRIGUEZ Omar	ESP	32
LOPES Tomas	POR	33
VIDAL Evan	FRA	34
REMPEL Blake	CAN	35
BIOSCA GARCIA Renat	ESP	36

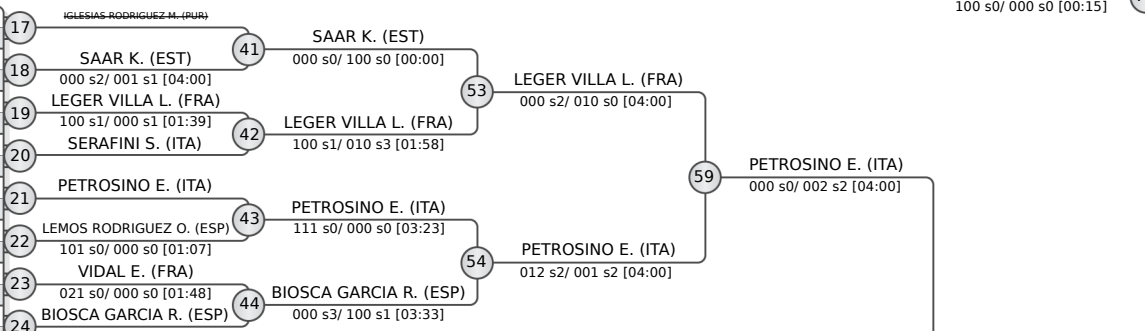

POOL D

MONTEIRO Davi	POR	37
PORTELLI Leonardo	ITA	38
SHAMUGIA KRILOV Davit	ESP	39
BOVE Daniele	ITA	40
DEVAIRE Mathys	FRA	41
GUTU Nichita	MDA	42
DE LAURENTIS Mattia	ITA	43
HAUACHE Mohammad	BRA	44
CECCOLI Jacopo	SMR	45
ALVAREZ CHILLIDA David	ESP	46
MONVILLE Clarence	FRA	47
IVANIC Karlo	CRO	48

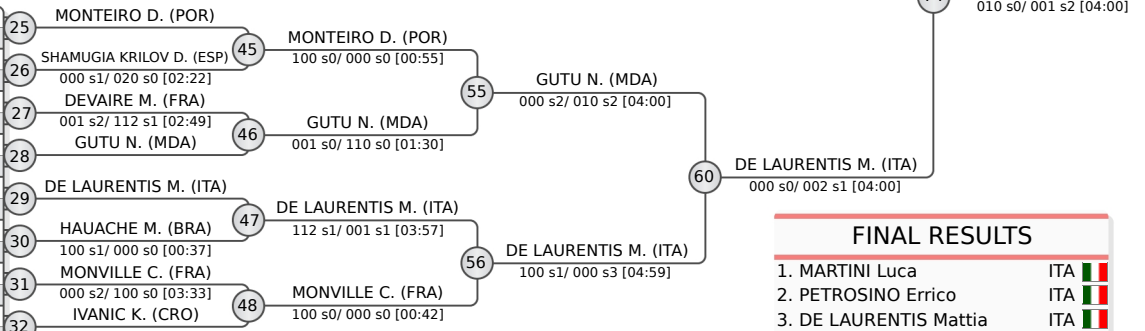

REPECHAGE

SANTOS J. (BRA)	61
BURGUILLO MATEO D. (ESP)	62
HILARIO R. (POR)	63
LEMONS RODRIGUEZ O. (ESP)	64
HAUACHE M. (BRA)	65

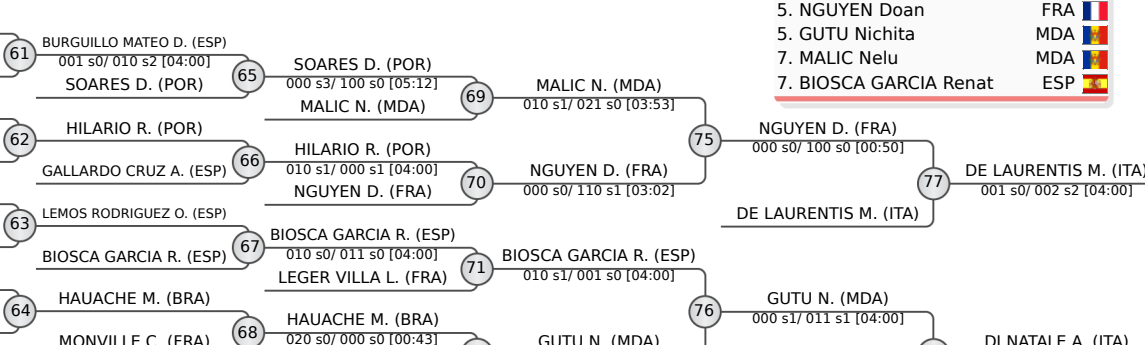

FINAL RESULTS		
1.	MARTINI Luca	ITA
2.	PETROSINO Errico	ITA
3.	DE LAURENTIS Mattia	ITA
3.	DI NATALE Andrea	ITA
5.	NGUYEN Doan	FRA
5.	GUTU Nichita	MDA
7.	MALIC Nelu	MDA
7.	BIOSCA GARCIA Renat	ESP





Faro Millennium Team Cadet European Cup 2026

Portugal, Faro/Algarve, 23-24 May 2026

-60 kg

Cadets (62)

POOL A

1	KELLY Kaian AUS	1	KELLY K. (AUS)	33	KELLY K. (AUS)
2	ALVAREZ LOPEZ Kevin ESP	2	LEONARD F. (CAN)	000 s0/ 100 s0 [02:28]	100 s0/ 000 s0 [00:26]
3	LEONARD Felix CAN	3	MARMIER J. (FRA)	000 s1/ 111 s0 [02:20]	SOALHEIRO A. (POR)
4	LLENA CARDIL Ivan ESP	4	SOALHEIRO A. (POR)	020 s0/ 000 s0 [03:17]	000 s1/ 010 s1 [04:00]
5	MARMIER Joshua FRA	5	CARABOTTO G. (ITA)	100 s0/ 000 s0 [01:19]	MIGUNOV GOMEZ M. (ESP)
6	SOALHEIRO Afonso POR	6	MIGUNOV GOMEZ M. (ESP)	000 s1/ 021 s0 [02:46]	000 s0/ 001 s0 [04:00]
7	VANARA Simone ITA	7	MEDJAHED A. (FRA)	000 s0/ 001 s2 [04:00]	101 s0/ 010 s0 [01:11]
8	CARABOTTO Gabriele ITA	8	SANCES TURON M. (ESP)	110 s0/ 000 s0 [03:56]	

POOL B

9	CHOI Isaac AUS	9	CHOI I. (AUS)	37	CHOI I. (AUS)
10	ESPANA SANTAMARIA Izan ESP	10	IVANCEA D. (ESP)	010 s0/ 011 s0 [04:00]	001 s2/ 000 s0 [04:00]
11	OJA Jan Rasmus EST	11	SFARLEA A. (ROU)	000 s0/ 101 s1 [03:14]	FASCETTO SIVILLO G. (ITA)
12	IVANCEA Daniel ESP	12	FASCETTO SIVILLO G. (ITA)	001 s2/ 000 s1 [04:29]	000 s0/ 100 s0 [02:46]
13	CRESPO PEREZ Saul ESP	13	FALCAO R. (BRA)	010 s2/ 000 s0 [04:11]	FALCAO R. (BRA)
14	SFARLEA Andrei ROU	14	HRISTOV E. (BUL)	100 s0/ 000 s3 [06:32]	001 s2/ 000 s2 [07:11]
15	FASCETTO SIVILLO Gianpaolo ITA	15	CHORNYI D. (ITA)	000 s0/ 100 s0 [01:08]	000 s1/ 111 s2 [03:58]
16	SERRANO Joao POR	16	NICOLAS T. (FRA)	000 s0/ 100 s0 [00:51]	

POOL C

17	CRUZALTA APODAC A Arath MEX	17	CRUZALTA APODAC A. (MEX)	41	CRUZALTA APODAC A. (MEX)
18	FARIA Simao POR	18	RIGOTE RODRIGUEZ E. (ESP)	000 s1/ 002 s0 [04:00]	010 s2/ 000 s0 [04:00]
19	RIGOTE RODRIGUEZ Eusebio ESP	19	DODERO A. (BRA)	100 s0/ 000 s0 [03:14]	010 s1/ 000 s2 [04:09]
20	DODERO Andre BRA	20	ADYLBKOV A. (KGZ)	000 s1/ 111 s2 [03:54]	021 s0/ 000 s0 [03:16]
21	CASTRO PAMPIN Raul ESP	21	MONTES OLIVA L. (ESP)	011 s0/ 001 s0 [04:34]	021 s0/ 000 s0 [03:16]
22	ESPOSTO Riccardo ITA	22	LOURO M. (POR)	000 s1/ 101 s1 [04:00]	002 s1/ 000 s1 [04:00]
23	ADYLBKOV Alymbek KGZ	23	PULIDO Joao POR	011 s1/ 001 s1 [04:00]	001 s0/ 020 s0 [02:57]
24	MONTES OLIVA Lucas ESP	24	SANCHEZ GARCIA M. (ESP)	100 s0/ 010 s0 [01:28]	

POOL D

25	TERAN VELAZQUEZ Ricardo Manuel MEX	25	TERAN VELAZQUEZ R. (MEX)	45	TERAN VELAZQUEZ R. (MEX)
26	MORATA CRUZ Daniel ESP	26	MAGGIA-ASMAKER R. (FRA)	000 s1/ 001 s1 [04:00]	001 s2/ 000 s0 [04:00]
27	AZARUMYAN Aren EST	27	MORETTI M. (ITA)	110 s0/ 000 s0 [00:38]	110 s0/ 000 s0 [00:42]
28	MAGGIA-ASMAKER Robinson FRA	28	FRAZAO M. (POR)	000 s0/ 010 s0 [04:00]	
29	MORETTI Mirko ITA	29	CENA F. (ITA)	001 s0/ 002 s1 [05:53]	010 s0/ 000 s1 [04:00]
30	HIDALGO ROJO Alejandro ESP	30	NEVES P. (POR)	010 s0/ 000 s1 [04:00]	000 s0/ 000 s0 [00:57]
31	DE VICENTE HERNANDO Marco ESP	31	HENSSENS N. (BEL)	000 s0/ 100 s0 [00:41]	100 s0/ 000 s0 [00:57]
32	FRAZAO Mateus POR	32	GESUELE E. (ITA)	000 s0/ 021 s0 [03:03]	

REPECHAGE

61	KOLOSOV K. (EST)	61	KOLOSOV K. (EST)	65	MEDJAHED A. (FRA)
62	CARABOTTO G. (ITA)	62	MEDJAHED A. (FRA)	66	HRISTOV E. (BUL)
63	MERA CARMONA A. (ESP)	63	HRISTOV E. (BUL)	67	CASTRO PAMPIN R. (ESP)
64	HRISTOV E. (BUL)	64	CASTRO PAMPIN R. (ESP)	68	JAAFAR M. (BUL)
65	CASTRO PAMPIN R. (ESP)	65	CRUZALTA APODAC A. (MEX)	69	JAAFAR M. (BUL)
66	ADYLBKOV A. (KGZ)	66	MONTES OLIVA L. (ESP)	70	JAAFAR M. (BUL)
67	JAAFAR M. (BUL)	67	JAAFAR M. (BUL)	71	JAAFAR M. (BUL)
68	NEVES P. (POR)	68	HENSSENS N. (BEL)	72	JAAFAR M. (BUL)

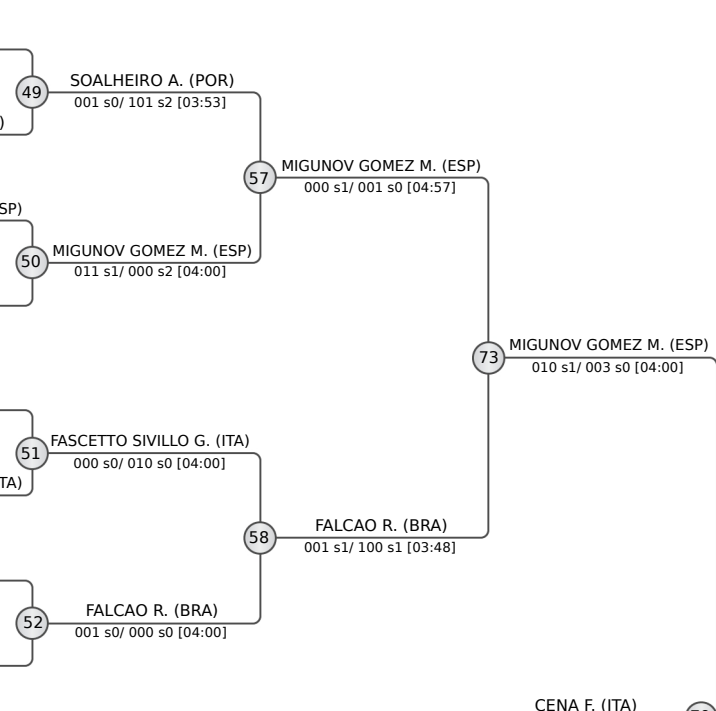

FINAL RESULTS		
1.	CENA Federico	ITA
2.	MIGUNOV GOMEZ Maksim	ESP
3.	DODERO Andre	BRA
3.	FALCAO Rafael	BRA
5.	HRISTOV Emo	BUL
5.	JAAFAR Mahmoud	BUL
7.	SOALHEIRO Afonso	POR
7.	CASTRO PAMPIN Raul	ESP





Faro Millennium Team Cadet European Cup 2026

Portugal, Faro/Algarve, 23-24 May 2026

-66 kg

Cadets (64)

POOL A

USA	LIMA Daniel	1	LIMA D. (USA)	001 s0/000 s2 [04:08]	33	LIMA D. (USA)	100 s0/000 s2 [03:27]	49	CIUFFREDA A. (ITA)	000 s3/100 s2 [05:49]
BRA	COELHO Joao	2	MODJTABAI M. (FRA)	100 s0/000 s0 [01:12]		MODJTABAI M. (FRA)				
FRA	MODJTABAI Mael	2	STASIEWICZ B. (POL)	020 s0/000 s0 [03:07]		STASIEWICZ B. (POL)				
ESP	GRELA ROMERO Samuel	3	CIUFFREDA A. (ITA)	001 s0/000 s2 [04:00]	34	CIUFFREDA A. (ITA)	000 s0/001 s0 [04:00]	57	CIUFFREDA A. (ITA)	100 s2/000 s3 [03:08]
POL	STASIEWICZ Blazej	3	PARLATI M. (ITA)	100 s0/000 s0 [01:11]		PARLATI M. (ITA)				
ITA	CIUFFREDA Andrea	4	ROBERT E. (FRA)	020 s0/000 s0 [01:41]	35	ROBERT E. (FRA)	100 s0/000 s0 [02:02]	50	PARLATI M. (ITA)	100 s0/000 s0 [00:28]
POR	SOARES Antonio	5	COSTA P. (POR)	002 s0/000 s1 [04:00]		COSTA P. (POR)				
ITA	PARLATI Marco	5	POLO LAGUNA M. (ESP)	000 s0/111 s0 [02:41]	36	POLO LAGUNA M. (ESP)				
EST	BEZUGLOV Ilja	6	POLO LAGUNA M. (ESP)	001 s0/000 s1 [04:00]		POLO LAGUNA M. (ESP)				
FRA	ROBERT Esteban	6								
ESP	BURLACU CACALETEANU Viad Andreas	7								
POR	COSTA Pedro Henrique	7								
ESP	GALAN VILLANUEVA Eric	8								
ESP	POLO LAGUNA Martin	8								
ROU	BALAN David	8								

POOL B

BUL	TODOROV Vladimir	9	TODOROV V. (BUL)	020 s0/000 s0 [00:44]	37	TODOROV V. (BUL)	020 s0/000 s1 [03:58]	51	TODOROV V. (BUL)	111 s0/000 s0 [01:39]
ESP	CARDIL BONSON Hector	10	KOIV S. (EST)	100 s0/000 s0 [00:39]		KOIV S. (EST)				
EST	KOIV Sebastian	10	DI BENEDETTO F. (ITA)	011 s0/000 s0 [04:00]	38	SACRISTAN GARCIA A. (ESP)	000 s0/100 s0 [00:29]	58	TODOROV V. (BUL)	101 s0/000 s0 [02:05]
CAN	RAESS Corsin	11	SACRISTAN GARCIA A. (ESP)	101 s0/000 s0 [03:20]		SACRISTAN GARCIA A. (ESP)				
ITA	DI BENEDETTO Francesco Robert	11	ASANO K. (AUS)	100 s0/000 s0 [00:18]	39	GOMEZ ANTONA J. (ESP)	000 s3/100 s2 [04:19]	52	GOMEZ ANTONA J. (ESP)	020 s0/000 s0 [00:58]
FRA	BERTELLIN Johan	12	GOMEZ ANTONA J. (ESP)	111 s1/000 s2 [01:26]		GOMEZ ANTONA J. (ESP)				
ESP	SACRISTAN GARCIA Adrian	12	GOULART L. (BRA)	010 s2/000 s0 [04:00]	40	GOULART L. (BRA)				
POR	PELLO Flavio	13	DZHABELOV I. (BEL)	022 s0/000 s0 [02:29]		DZHABELOV I. (BEL)				
AUS	ASANO Kento	13	TAMIETTI Lenzo			TAMIETTI Lenzo				
POR	FRANCA Tomas	14								
ESP	GOMEZ ANTONA Javier	14								
ITA	MEREU Alessandro	15								
BRA	GOULART Liam	15								
ESP	MATEOS SAN VICENTE Diego	16								
BEL	DZHABELOV Imran	16								
FRA	TAMIETTI Lenzo	16								

POOL C

BRA	SACILOTTO Bruno	17	SACILOTTO B. (BRA)	010 s0/000 s1 [04:00]	41	LIZANA LEON M. (ESP)	000 s0/001 s2 [04:36]	53	LIZANA LEON M. (ESP)	100 s0/000 s0 [02:52]
ITA	GIORGIANI Alessio	18	LIZANA LEON M. (ESP)	021 s0/010 s0 [02:39]		LIZANA LEON M. (ESP)				
ESP	LIZANA LEON Marcos	18	BLANCO LLUCH P. (ESP)	000 s0/101 s2 [07:48]	42	BLANCO LLUCH P. (ESP)	110 s0/000 s0 [03:51]	59	GABAYEV Y. (BEL)	001 s0/100 s0 [02:40]
FRA	SEMENADISSE Quentin	19	SILVA T. (POR)	002 s1/000 s0 [04:00]		SILVA T. (POR)				
EST	TROMMEL Sten	20	DIMITROV S. (BUL)	100 s2/000 s1 [06:29]	43	GABAYEV Y. (BEL)	000 s0/011 s0 [04:00]	54	GABAYEV Y. (BEL)	101 s2/000 s0 [03:44]
ESP	BLANCO LLUCH Pol	20	GABAYEV Y. (BEL)	000 s0/020 s0 [00:52]		GABAYEV Y. (BEL)				
POR	SILVA Tomas	21	OVCHARENKO N. (FRA)	000 s0/001 s0 [04:00]	44	DI GIANNI F. (ITA)	000 s3/111 s0 [02:30]	60	MOGA V. (MDA)	000 s0/020 s1 [02:09]
ESP	VAZQUEZ IGLESIAS Martin	22	DI GIANNI F. (ITA)	000 s1/010 s1 [04:00]		DI GIANNI F. (ITA)				
BUL	DIMITROV Samuil	23								
POR	MONGINHO Duarte	24								
ESP	JIMENEZ PATRON Javier	25								
BEL	GABAYEV Yacine	26								
ESP	FREIRES MARISCAL Ricardo	27								
ESP	OVCHARENKO Nikita	28								
FRA	OVCHARENKO Nikita	29								
ANG	NSINGANI Ezequiel	30								
ITA	DI GIANNI Federico	31								

POOL D

POL	WISNIEWSKI Dawid	25	WISNIEWSKI D. (POL)	110 s0/011 s0 [02:37]	45	MORANTE DELGADO A. (ESP)	000 s0/100 s0 [00:12]	55	MORANTE DELGADO A. (ESP)	011 s1/002 s1 [04:00]
ESP	LAGO PEREZ Pancho	26	MORANTE DELGADO A. (ESP)	021 s0/010 s0 [02:21]		MORANTE DELGADO A. (ESP)				
ESP	MORANTE DELGADO Agustin	26	AAMODT A. (NOR)	000 s1/010 s1 [04:41]	46	AAMODT A. (NOR)	110 s1/001 s0 [04:00]	56	MOGA V. (MDA)	000 s0/102 s0 [02:55]
ITA	SAMKHARADZE Lazare	27	LAGES F. (POR)	001 s0/101 s1 [03:02]		LAGES F. (POR)				
FRA	DESTALMINIL Leo	28	RADOSEVIC O. (MNE)	010 s2/000 s0 [04:00]	47	RADOSEVIC O. (MNE)	011 s0/000 s0 [04:00]	60	MOGA V. (MDA)	000 s0/020 s1 [02:09]
NOR	AAMODT Axel	27	MARANDYAN L. (ESP)	000 s0/100 s1 [03:08]		MARANDYAN L. (ESP)				
ESP	ROMERO GONZALEZ Fernando	28	D ANDREIS L. (ITA)	000 s0/100 s0 [00:41]	31	D ANDREIS L. (ITA)				
POR	LAGES Francisco	29	MOGA V. (MDA)	100 s0/000 s1 [03:38]	48	MOGA V. (MDA)	000 s0/100 s0 [00:39]	60	MOGA V. (MDA)	000 s0/020 s1 [02:09]
MNE	RADOSEVIC Ognjen	29								
FRA	SERRA Joan	30								
POR	FARIA Dinis	31								
ESP	MARANDYAN Lemuel	32								
ESP	ALVAREZ LOPEZ Hugo	32								
ITA	D ANDREIS Luca	31								
MDA	MOGA Vladislav	32								
FRA	NIZAR Louay	32								

REPECHAGE

POR	SOARES A. (POR)	61	SOARES A. (POR)	100 s1/000 s0 [02:56]	65	SOARES A. (POR)	001 s0/000 s1 [04:00]	69	SOARES A. (POR)	100 s2/000 s1 [05:49]
POL	STASIEWICZ B. (POL)	62	LIMA D. (USA)	020 s1/000 s0 [03:31]		PARLATI M. (ITA)				
ESP	CARDIL BONSON H. (ESP)	62	CARDIL BONSON H. (ESP)	000 s0/101 s0 [01:40]	66	SACRISTAN GARCIA A. (ESP)	000 s0/020 s0 [01:25]	70	GOMEZ ANTONA J. (ESP)	000 s1/010 s1 [04:00]
EST	KOIV S. (EST)	63	SACRISTAN GARCIA A. (ESP)	000 s0/000 s0 [00:00]		GOMEZ ANTONA J. (ESP)				
ESP	JIMENEZ PATRON J. (ESP)	63	DIMITROV S. (BUL)	001 s1/000 s2 [04:00]	67	DIMITROV S. (BUL)	010 s0/000 s1 [04:20]	71	LIZANA LEON M. (ESP)	
BUL	DIMITROV S. (BUL)	64	DI GIANNI F. (ITA)			LIZANA LEON M. (ESP)				
FRA	NIZAR L. (FRA)	64	RADOSEVIC O. (MNE)			RADOSEVIC O. (MNE)				
ITA	D ANDREIS L. (ITA)	64	RADOSEVIC O. (MNE)			RADOSEVIC O. (MNE)				
			MORANTE DELGADO A. (ESP)			MORANTE DELGADO A. (ESP)				

FINAL RESULTS

- GABAYEV Yacine BEL
- CIUFFREDA Andrea ITA
- GOMEZ ANTONA Javier ESP
- TODOROV Vladimir BUL
- MOGA Vladislav MDA
- RADOSEVIC Ognjen MNE
- SOARES Antonio POR
- DIMITROV Samuil BUL

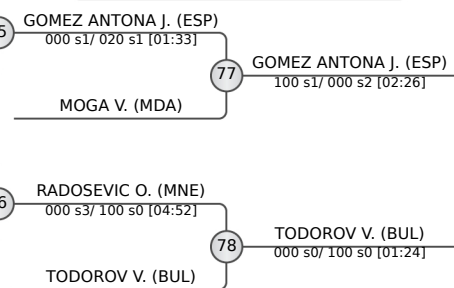



Faro Millennium Team Cadet European Cup 2026

Portugal, Faro/Algarve, 23-24 May 2026

-73 kg

Cadets (58)

POOL A

1	NIKOLCHEV Ivan (BUL)	1	NIKOLCHEV I. (BUL)	33	NIKOLCHEV I. (BUL)
2	CATALDO Giovanni (ITA)	2	DEVOS M. (FRA)	34	ROUSSINEAU I. (FRA)
3	DEVOS Max (FRA)	3	CAPUCHO D. (POR)	35	BASSO G. (ITA)
4	POGGIALI Luca (SMR)	4	ROUSSINEAU I. (FRA)	36	TOOMPARK T. (EST)
5	CAPUCHO Diogo (POR)	5	TOMIC A. (CRO)	37	CECI E. (ITA)
6	LAGO ROSELLO Sergio (ESP)	6	BASSO G. (ITA)	38	JORDAN M. (FRA)
7	ROUSSINEAU Isaac (FRA)	7	TOOMPARK T. (EST)	39	KRYSZCZAK E. (BEL)
8	TOMIC Andrija (CRO)	8	DAVELU COURIAT H. (FRA)	40	DRIDI S. (FRA)
9	SOUSA Lourenco (POR)				
10	BETANCORT GOMEZ Nil (ESP)				
11	BASSO Gabriele (ITA)				
12	SANTARELLI Gabriele (ITA)				
13	TOOMPARK Taavi (EST)				
14	DAVELU COURIAT Hugo (FRA)				
15	PUJOL RIOS Albert (ESP)				

POOL B

9	CECI Emiliano (ITA)	9	CECI E. (ITA)	37	CECI E. (ITA)
10	HUERTA MANSILLA Kevin (ESP)	10	MANSOURI R. (FRA)	38	JORDAN M. (FRA)
11	MANSOURI Rayane (FRA)	11	JORDAN M. (FRA)	39	KRYSZCZAK E. (BEL)
12	CLAGER PUYAL Antonio (ESP)	12	SANTORO D. (ITA)	40	DRIDI S. (FRA)
13	JORDAN Matheo (FRA)	13	SANUDO SAMPERIO D. (ESP)	41	GAYOL GRANDA G. (ESP)
14	SANTORO Daniele (ITA)	14	KRYSZCZAK E. (BEL)	42	BELMONT L. (FRA)
15	MATOS Martim (POR)	15	DRIDI S. (FRA)	43	MORENO ECHEVARRIA S. (ESP)
16	SANUDO SAMPERIO Dario (ESP)	16	RUIZ AMATE M. (ESP)	44	RIZZELLI F. (ITA)
17	MARINKOVIC Nikola (SRB)				
18	KRYSZCZAK Egor (BEL)				
19	DRIDI Sosthene (FRA)				
20	DELLO VICARIO Emanuele (ITA)				
21	RUIZ AMATE Miguel (ESP)				
22	SANTOS Samuel (POR)				

POOL C

17	GAYOL GRANDA Gonzalo (ESP)	17	GAYOL GRANDA G. (ESP)	41	GAYOL GRANDA G. (ESP)
18	ROSA Miguel (POR)	18	HOVEN M. (NOR)	42	BELMONT L. (FRA)
19	HOVEN Max Theodor (NOR)	19	BELMONT L. (FRA)	43	MORENO ECHEVARRIA S. (ESP)
20	SANTORO Edoardo (ITA)	20	HEPAYAN A. (BEL)	44	RIZZELLI F. (ITA)
21	BELMONT Leandre (FRA)	21	MARY G. (FRA)	45	BACCHINI M. (ITA)
22	GALLEGO VALENCIA Adan (ESP)	22	MORENO ECHEVARRIA S. (ESP)	46	HUERTA MANSILLA H. (ESP)
23	HEPAYAN Aleksii (BEL)	23	RIZZELLI F. (ITA)	47	KOKOEV KOKOEV B. (ESP)
24	MELONI Giacomo (ITA)	24	LASCAU T. (ROU)	48	FERRAND S. (FRA)
25	MARY Gabin (FRA)				
26	MORENO ECHEVARRIA Samuel (ESP)				
27	ROSA Afonso (POR)				
28	RIZZELLI Francesco (ITA)				
29	PALUD Gabin (FRA)				
30	LASCAU Tudor (ROU)				
31	CALVO LEON Alvaro (ESP)				

POOL D

25	BACCHINI M. (ITA)	25	BACCHINI M. (ITA)	45	BACCHINI M. (ITA)
26	HUERTA MANSILLA Hugo (ESP)	26	HUERTA MANSILLA H. (ESP)	46	HUERTA MANSILLA H. (ESP)
27	HOROBETS Maksym (POR)	27	HOROBETS M. (POR)	47	KOKOEV KOKOEV B. (ESP)
28	VASICURO Gabriele (ITA)	28	KOKOEV KOKOEV B. (ESP)	48	FERRAND S. (FRA)
29	KOKOEV KOKOEV Batraz (ESP)	29	LE GUYADER M. (FRA)	49	ANCKAERT T. (BEL)
30	LE GUYADER Maxime (FRA)	30	MORICONI Daniele (ITA)	50	ANCKAERT T. (BEL)
31	MORICONI Daniele (ITA)	31	MARTINEZ PONCE Manuel Jesus (ESP)	51	BACCHINI M. (ITA)
32	MARTINEZ PONCE Manuel Jesus (ESP)	32	DIAS T. (POR)	52	ANCKAERT T. (BEL)
33	DIAS Tiago (POR)	33	FERRAND S. (FRA)	53	GAYOL GRANDA G. (ESP)
34	FERRAND Sacha (FRA)	34	ANCKAERT T. (BEL)	54	RIZZELLI F. (ITA)
35	AMANZHOL Baladil (POL)	35	HUERTA MANSILLA H. (ESP)	55	BACCHINI M. (ITA)

REPECHAGE

61	DEVOS M. (FRA)	61	DEVOS M. (FRA)	65	DEVOS M. (FRA)
62	MANSOURI R. (FRA)	62	JORDAN M. (FRA)	66	JORDAN M. (FRA)
63	HOVEN M. (NOR)	63	HOVEN M. (NOR)	67	BELMONT L. (FRA)
64	ANCKAERT T. (BEL)	64	ANCKAERT T. (BEL)	68	ANCKAERT T. (BEL)
65	ROUSSINEAU I. (FRA)	65	ROUSSINEAU I. (FRA)	69	BASSO G. (ITA)
66	MANSOURI R. (FRA)	66	JORDAN M. (FRA)	70	DRIDI S. (FRA)
67	HOVEN M. (NOR)	67	HOVEN M. (NOR)	71	BELMONT L. (FRA)
68	ANCKAERT T. (BEL)	68	HUERTA MANSILLA H. (ESP)	72	ANCKAERT T. (BEL)
69	DEVOS M. (FRA)	69	DEVOS M. (FRA)	73	NIKOLCHEV I. (BUL)
70	JORDAN M. (FRA)	70	JORDAN M. (FRA)	74	GAYOL GRANDA G. (ESP)
71	BELMONT L. (FRA)	71	BELMONT L. (FRA)	75	BASSO G. (ITA)
72	ANCKAERT T. (BEL)	72	ANCKAERT T. (BEL)	76	ANCKAERT T. (BEL)
73	NIKOLCHEV I. (BUL)	73	NIKOLCHEV I. (BUL)	77	BACCHINI M. (ITA)
74	GAYOL GRANDA G. (ESP)	74	GAYOL GRANDA G. (ESP)	78	ANCKAERT T. (BEL)
75	BASSO G. (ITA)	75	BASSO G. (ITA)	79	NIKOLCHEV I. (BUL)
76	ANCKAERT T. (BEL)	76	ANCKAERT T. (BEL)		
77	BACCHINI M. (ITA)	77	BACCHINI M. (ITA)		
78	ANCKAERT T. (BEL)	78	ANCKAERT T. (BEL)		
79	NIKOLCHEV I. (BUL)	79	NIKOLCHEV I. (BUL)		

FINAL RESULTS

1.	NIKOLCHEV Ivan	BUL
2.	GAYOL GRANDA Gonzalo	ESP
3.	BACCHINI M. (ITA)	ITA
3.	ANCKAERT T. (BEL)	BEL
5.	BASSO Gabriele	ITA
5.	CECI Emiliano	ITA
7.	DRIDI Sosthene	FRA
7.	BELMONT Leandre	FRA



Faro Millennium Team Cadet European Cup 2026

Portugal, Faro/Algarve, 23-24 May 2026

-81 kg

Cadets (39)

POOL A

MELLO Yago	BRA	1	MELLO Y. (BRA)	33	MELLO Y. (BRA)
PICANCO Goncalo	POR	2	HRISTOFOROV B. (EST)	100 s0/ 002 s0 [02:14]	
HRISTOFOROV Bruno	EST		000 s1/ 100 s1 [02:42]		
MAZZOLI Valerio	ITA	3	MAZZOLI V. (ITA)	34	RODRIGUEZ BERMUDEZ A. (ESP)
RODRIGUEZ BERMUDEZ Adrian	ESP	4	RODRIGUEZ BERMUDEZ A. (ESP)	000 s0/ 101 s1 [02:05]	
SERPA Henrique	POR	5	SERPA H. (POR)	35	COSERIC E. (MDA)
COSERIC Egor	MDA	6	COSERIC E. (MDA)	000 s1/ 100 s1 [05:35]	
MONPIERRE Lukas	FRA	7	ERIKSON M. (EST)	36	SAVARESE C. (ITA)
ERIKSON Mattias	EST		SAVARESE C. (ITA)	001 s3/ 101 s2 [07:29]	
SAVARESE Cristian	ITA	8			

POOL B

TOOMEL Joosep	EST	9	TOOMEL J. (EST)	37	TOOMEL J. (EST)
KUNSZABO Matei	ROU	10	KOYEV E. (ESP)	001 s1/ 100 s0 [02:28]	
KOYEV Egor	ESP		TUMBARELL VEITIA Osniel Guillermo	38	SILVA V. (POR)
TUMBARELL VEITIA Osniel Guillermo	ITA	11	TUMBARELL VEITIA O. (ITA)	002 s1/ 010 s0 [04:00]	
SILVA Vicente	POR	12	SILVA V. (POR)	39	PARISI C. (ITA)
PARISI Cristian	ITA	13	PARISI C. (ITA)	100 s0/ 000 s2 [02:13]	
TORRERO TORRES Jesus	ESP	14	TORRERO TORRES J. (ESP)	40	VILARINHO V. (POR)
VILARINHO Vicente	POR	15	VILARINHO V. (POR)	100 s0/ 000 s0 [01:23]	
DAUPHIN Leny	FRA	16	DAUPHIN L. (FRA)		

POOL C

TOPP Kai	AUS	17	TOPP K. (AUS)	41	TOPP K. (AUS)
ARBULLA Alessandro	ITA	18	ARBULLA A. (ITA)	020 s0/ 000 s0 [01:24]	
CANEPARI Riccardo	ITA	19	MAURY A. (FRA)	000 s1/ 100 s1 [03:15]	
MAURY Adrien	FRA		COUTINHO H. (POR)	42	MAURY A. (FRA)
COUTINHO Henrique	POR	20	COUTINHO H. (POR)	100 s0/ 000 s0 [00:29]	
PEREIRA Davi	BRA	21	PEREIRA D. (BRA)	43	PEREIRA D. (BRA)
RUSSO Antonio	ITA	22	RUSSO A. (ITA)	100 s0/ 001 s0 [01:52]	
ALIKHANOV Amir	EST	23	VALCANERAS BLANES T. (ESP)	000 s1/ 011 s0 [04:00]	
VALCANERAS BLANES Toni	ESP		STAPULIONIS K. (NOR)	44	VALCANERAS BLANES T. (ESP)
STAPULIONIS Kajus	NOR	24	STAPULIONIS K. (NOR)	100 s0/ 000 s0 [00:42]	

POOL D

KIKAS Aleksei	EST	25	KIKAS A. (EST)	45	KIKAS A. (EST)
SUAREZ MIERA Lucas	ESP	26	SUAREZ MIERA L. (ESP)	002 s1/ 000 s2 [04:00]	
MARINKOVIC Aleksandar	SRB	27	GOMES G. (POR)	46	DEL MONTE D. (ITA)
GOMES Guilherme	POR		DEL MONTE D. (ITA)	001 s1/ 002 s1 [04:08]	
DEL MONTE Dennis	ITA	28	DEL MONTE D. (ITA)	47	MUGNERET J. (FRA)
MATHUES Sid	BEL	29	MATHUES S. (BEL)	000 s0/ 012 s0 [04:00]	
HERNANDEZ MORAN Sergio	ESP	30	MUGNERET J. (FRA)	000 s0/ 100 s0 [00:24]	
MUGNERET Joshua	FRA		CANTER F. (ITA)	48	CANTER F. (ITA)
CANTER Filippo	ITA	31	CANTER F. (ITA)	100 s1/ 011 s0 [01:25]	
CORREIA Goncalo Almeida	POR	32	CORREIA G. (POR)		

REPECHAGE

MONPIERRE L. (FRA)	61	MONPIERRE L. (FRA)	65	MONPIERRE L. (FRA)	69	MELLO Y. (BRA)
SERPA H. (POR)		SAVARESE C. (ITA)	011 s0/ 000 s0 [04:00]	MELLO Y. (BRA)	000 s1/ 020 s0 [01:45]	
TORRERO TORRES J. (ESP)	62	TORRERO TORRES J. (ESP)	66	TORRERO TORRES J. (ESP)	70	SILVA V. (POR)
ALIKHANOV A. (EST)		VILARINHO V. (POR)	100 s0/ 000 s0 [00:19]	SILVA V. (POR)	000 s1/ 011 s0 [04:00]	
STAPULIONIS K. (NOR)	63	ALIKHANOV A. (EST)	67	ALIKHANOV A. (EST)	71	ALIKHANOV A. (EST)
HERNANDEZ MORAN S. (ESP)		PEREIRA D. (BRA)	100 s0/ 000 s0 [00:01]	TOPP K. (AUS)	011 s1/ 000 s2 [04:00]	
MATHUES S. (BEL)	64	MATHUES S. (BEL)	68	MATHUES S. (BEL)	72	MATHUES S. (BEL)
		CANTER F. (ITA)	100 s0/ 000 s0 [01:04]	KIKAS A. (EST)	100 s1/ 000 s0 [04:33]	

FINAL RESULTS

- COSERIC Egor MDA
- VALCANERAS BLANES Toni ESP
- MELLO Yago BRA
- MATHUES Sid BEL
- MUGNERET Joshua FRA
- PARISI Cristian ITA
- SILVA Vicente POR
- ALIKHANOV Amir EST





Faro Millennium Team Cadet European Cup 2026

Portugal, Faro/Algarve, 23-24 May 2026

+ 90 kg

Cadets (15)

POOL A

	PEREIRA Jose Paulo	BRA
	LODDES Romet	EST
	MASCARO GUERRERO Daniel	ESP

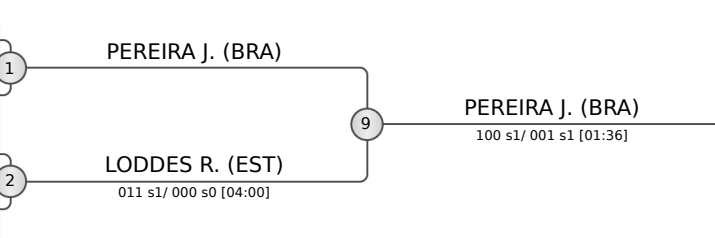

POOL B

	ENDELADZE Teimurazi	ITA
	SUBERLAK Ridley	CAN
	OSTROVSCHII Vladimir	POR
	LALIASHVILI Giorgi	ESP

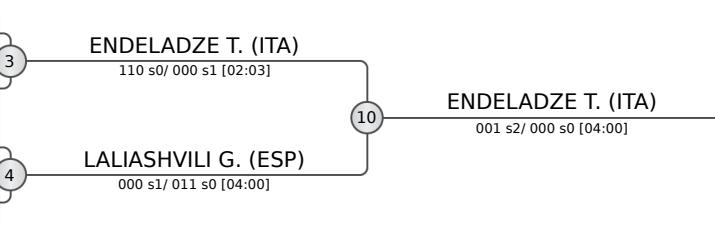

POOL C

	LABATE Federico	ITA
	ARAUJO-DE-JESUS-Rodrigo	POR
	BAYRAMOV VOZNESENKY Rafael Liberty	ESP
	RAMMO Johan	EST

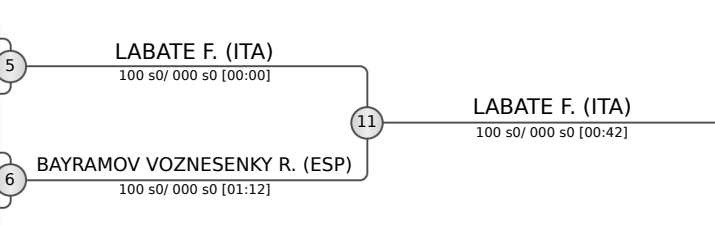

POOL D

	VALKOV Tsvetomir	BUL
	ROSA Marcus	BRA
	SAURA Nathan	FRA
	SANTOS Daniel Rodrigues	POR

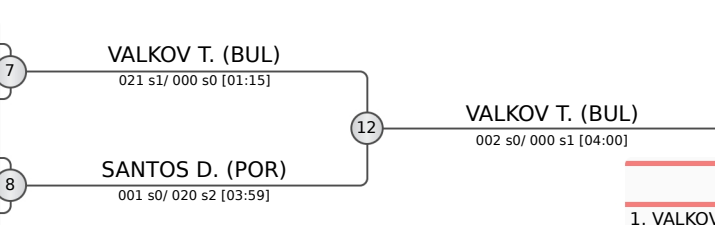

REPECHAGE

LODDES R. (EST)	13
SUBERLAK R. (CAN)	14
LALIASHVILI G. (ESP)	14
ARAUJO-DE-JESUS R. (POR)	15
BAYRAMOV VOZNESENKY R. (ESP)	15
ROSA M. (BRA)	16
SANTOS D. (POR)	16

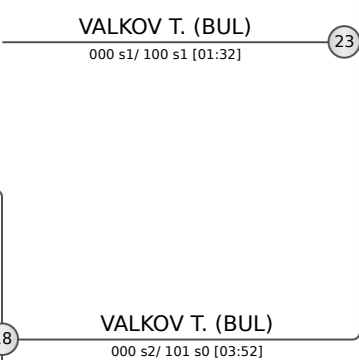
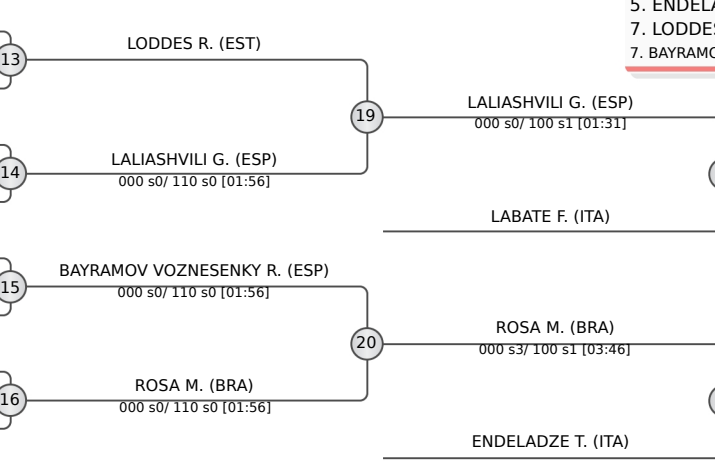

FINAL RESULTS		
1.	VALKOV Tsvetomir	BUL
2.	PEREIRA Jose Paulo	BRA
3.	LALIASHVILI Giorgi	ESP
3.	ROSA Marcus	BRA
5.	LABATE Federico	ITA
5.	ENDELADZE Teimurazi	ITA
7.	LODDES Romet	EST
7.	BAYRAMOV VOZNESENKY Rafael Liberty	ESP





Faro Millennium Team Cadet European Cup 2026

Portugal, Faro/Algarve, 23-24 May 2026

-40 kg

Cadets (8)

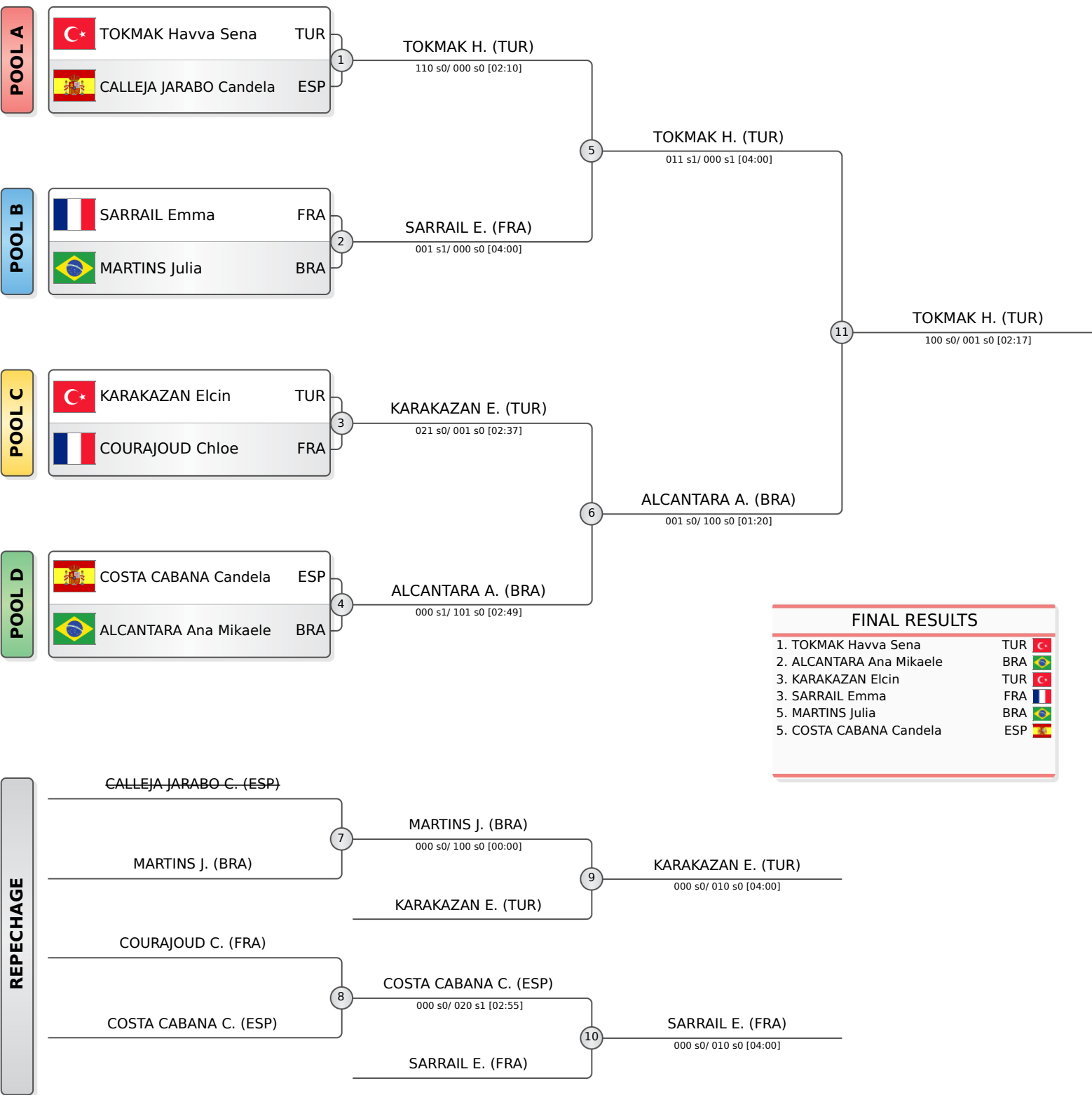

FINAL RESULTS		
1.	TOKMAK Havva Sena	TUR
2.	ALCANTARA Ana Mikaele	BRA
3.	KARAKAZAN Elcin	TUR
3.	SARRAIL Emma	FRA
5.	MARTINS Julia	BRA
5.	COSTA CABANA Candela	ESP





Faro Millennium Team Cadet European Cup 2026

Portugal, Faro/Algarve, 23-24 May 2026

-48 kg

Cadets (35)

POOL A

	IMHOF Giovanna	BRA	1
	TESI Cecilia	ITA	2
	CARVALHO Mariana	POR	3
	SADABA CORBACHO June	ESP	4
	VIEIRA Lena	FRA	5
	FILIPOVIC Mia	SRB	6
	MATA NUNEZ Marta	ESP	7
	PEREIRA Guida	POR	8

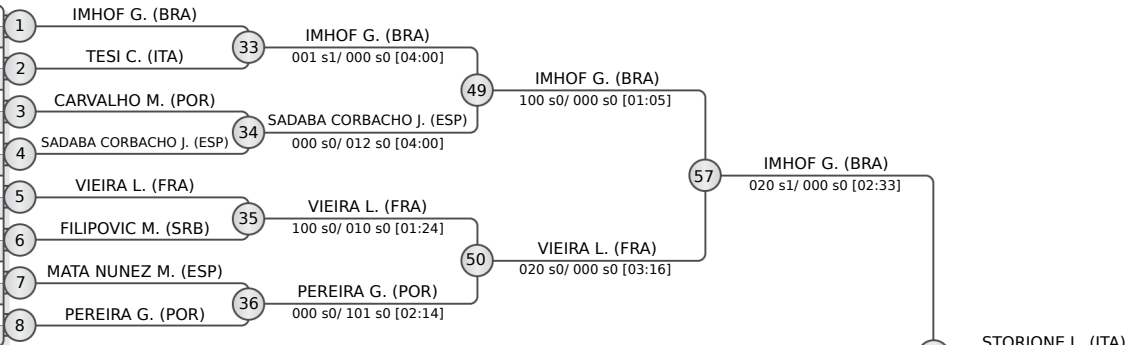

POOL B

	STORIONE Ludovica	ITA	9
	TRANVOUEZ Alyssa	FRA	10
	AVIGDOR Gili Tamar	ISR	11
	SOARES Maria	POR	12
	HAMRI OULAD AZZOUD Dina	ESP	12
	MIZIARA Maria	BRA	13
	DUTARTRE Ciara	FRA	14
	MARTINEZ Navia	BEL	15
	SANTIN MORENO Miriam	ESP	16

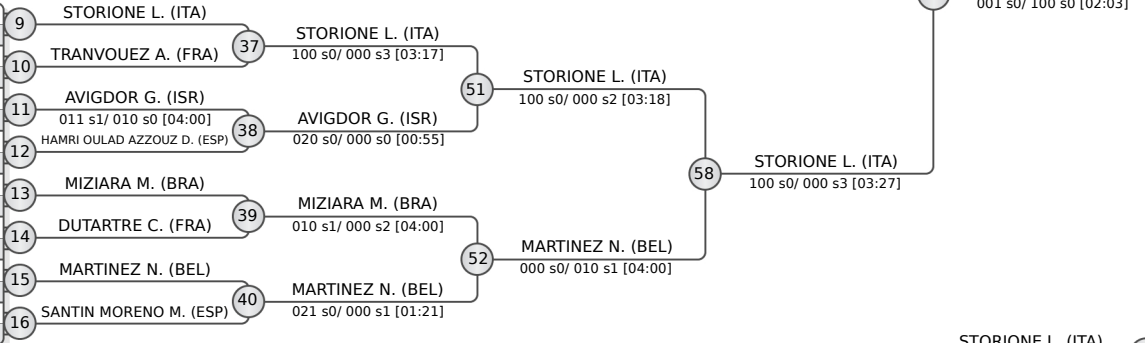

POOL C

	MONTALBANO Aurora	ITA	17
	CARO NAMYASENKO Carolina	ESP	18
	KAYIR Livanur	TUR	19
	MACIEL Maria	BRA	20
	AZARUMYAN Anna	EST	21
	GOIMIER Valentine	FRA	22
	IVALDI Beatrice	ITA	23
	FRANCO Carolina	POR	23
	NUNEZ CAZADO Andrea	ESP	24

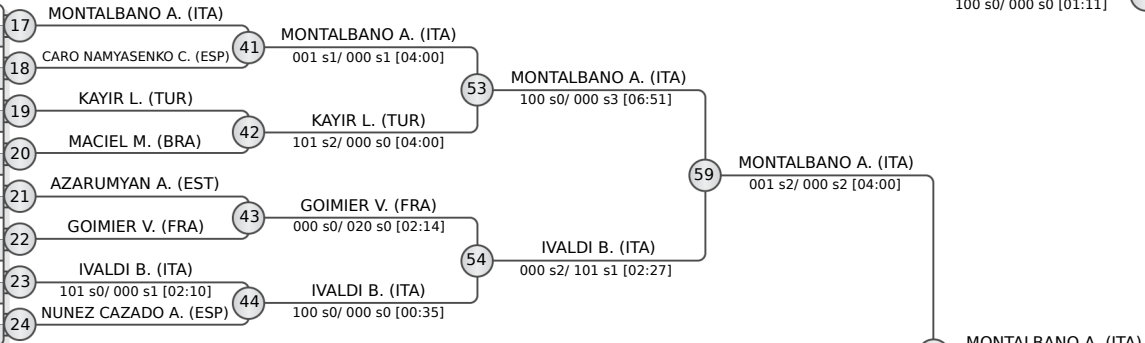

POOL D

	COOK Abbey	AUS	25
	FRANCO Agata	ITA	26
	JNAOUI Celya	FRA	27
	MORENO TORRES Eva	ESP	28
	GRIGORYAN Viktoria	BEL	29
	SINOGAS Ines	POR	30
	LI Anna	CAN	31
	SANTOS Micaela	BRA	31
	GRECU Beatriz	POR	32

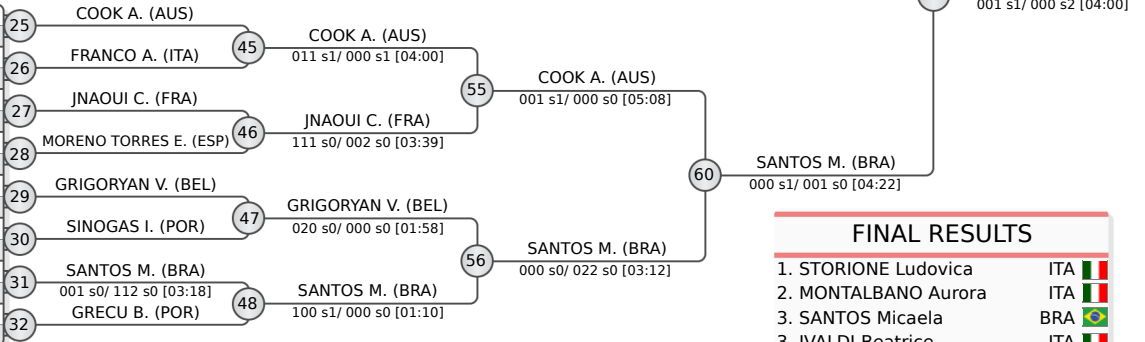

FINAL RESULTS		
1.	STORIONE Ludovica	ITA
2.	MONTALBANO Aurora	ITA
3.	SANTOS Micaela	BRA
3.	IVALDI Beatrice	ITA
5.	TRANVOUEZ Alyssa	FRA
7.	TESI Cecilia	ITA
7.	COOK Abbey	AUS

REPECHAGE

TESI C. (ITA)	61	TESI C. (ITA)	65	TESI C. (ITA)	69
TRANVOUEZ A. (FRA)	62	TRANVOUEZ A. (FRA)	66	TRANVOUEZ A. (FRA)	70
CARO NAMYASENKO C. (ESP)	63	KAYIR L. (TUR)	67	IVALDI B. (ITA)	71
LI A. (CAN)	64	GRIGORYAN V. (BEL)	68	COOK A. (AUS)	72

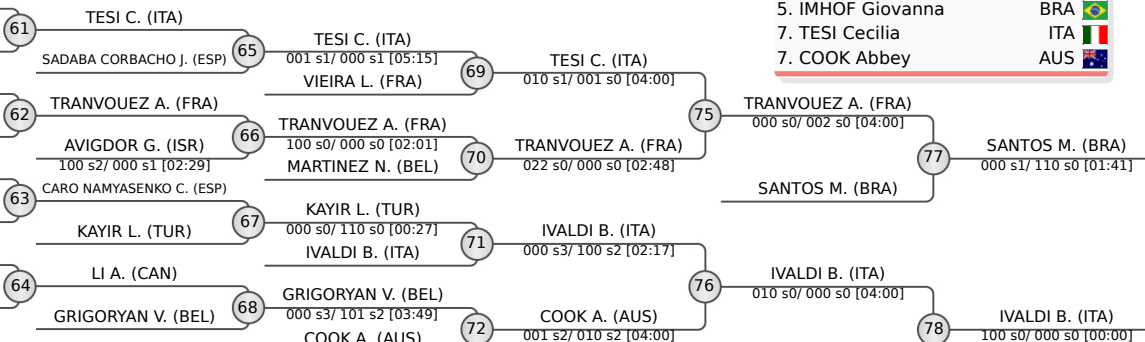



Faro Millennium Team Cadet European Cup 2026

Portugal, Faro/Algarve, 23-24 May 2026

-52 kg

Cadets (51)

POOL A

CHIRON Alexandra	MDA
MARTHOS Alice	FRA
ROMERA BARRAGAN Aniana	ESP
VUKSANOVIC Tena	CRO
GALINHO Joana	POR
SANFELIX MONTMANY Laina	ESP
HIROSE Rika	AUS
DOBROVOLSCHI Emma	ITA
CALHEIROS Diana	POR
DIAZ NAFAR Carlota	ESP
LUDWIG Valentine	FRA
YILMAZ Betul	TUR

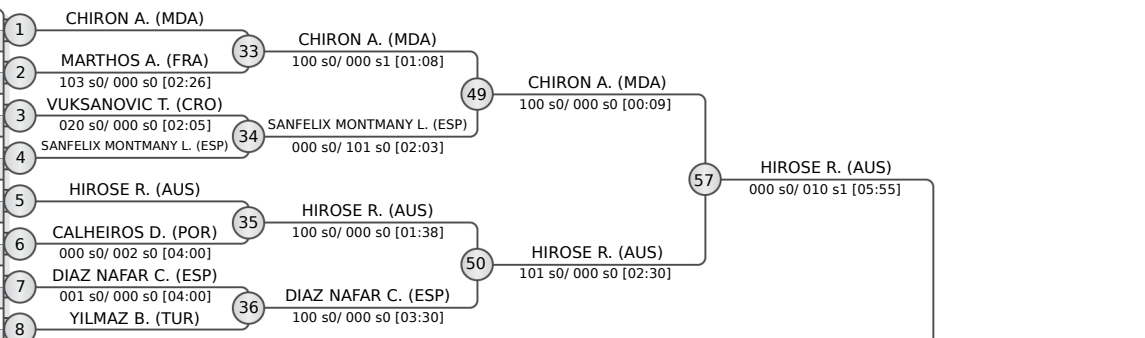

POOL B

LAVRENOVA Kamila	UKR
TIXIER Line	FRA
DOMINGOS Ines	POR
REPOLA Maia	ITA
FERREIRA Iris	POR
PECQUEUX Maeë	FRA
SOLANO BADIA Sara	ESP
MARIELLO Matilda	ITA
ROBLES GASQUE Mar	ESP
RUSHFELDT Ariane	NOR
MARIANO Beatriz	POR
BOUALEM Norhene	FRA
SOUSA LAVANDEIRA Zeltia	ESP

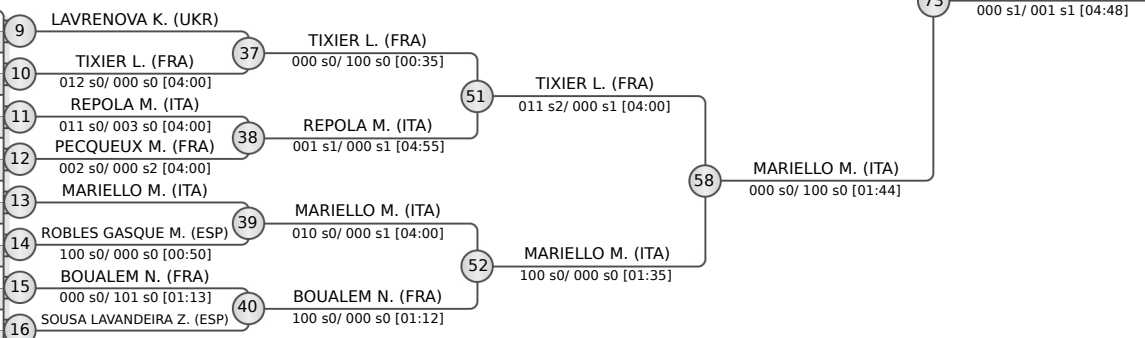

POOL C

GASPAR Sofia	POR
CADIGNAN Oriane	FRA
ARAGON ANTON Barbara	ESP
GUION Sofia	ITA
WELLEKENS Amelie	BEL
LARANJINHA Violeta	POR
BOSKUP Aysenur	TUR
TORRISI Luna	ITA
MARTIN TORRES Jimena	ESP
VAINER Xenia	MDA
NOURISSON Emma	FRA
SILVA Noa	POR
SORIANO PINERO Nora	ESP

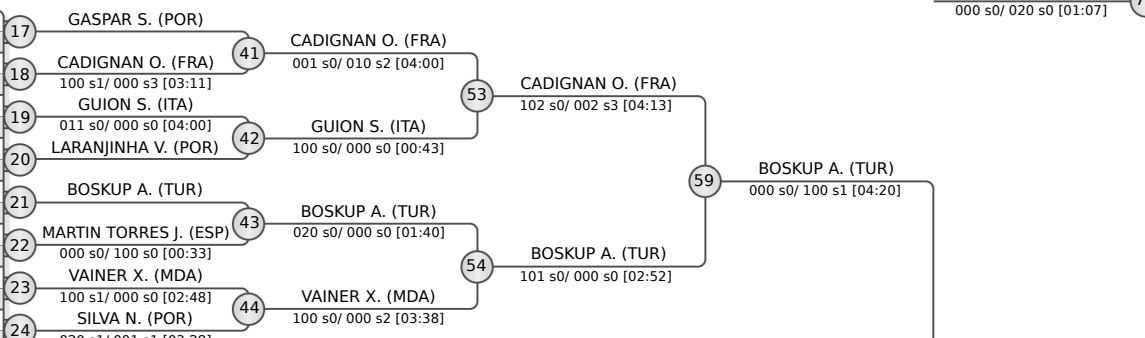

POOL D

VADOVICOVA Vivien	SVK
TERES CEREZA Daniela	ESP
GOULART Vitoria	POR
DI RUZZA Emma	ITA
OLARRA ERENTXUN Janire	ESP
BELMONT Cassandre	FRA
SIMIC Tea	BIH
CRUZ Giovanna	BRA
LOUVET ECHE Pauline	FRA
MAGNANI Guenda	ITA
SANTOS Carolina	POR
CALVO LEON Lola	ESP
BROADLEY Maisie	GBR

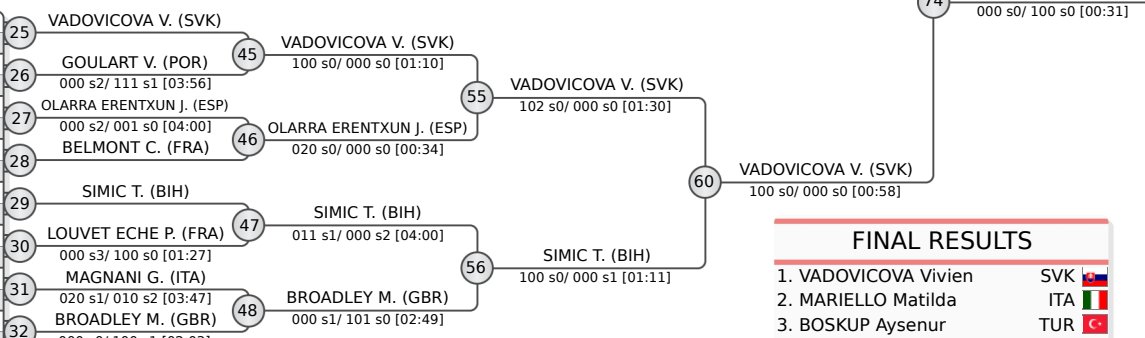

FINAL RESULTS		
1. VADOVICOVA Vivien	SVK	
2. MARIELLO Matilda	ITA	
3. BOSKUP Aysenur	TUR	
3. HIROSE Rika	AUS	
5. ROBLES GASQUE Mar	ESP	
5. SIMIC Tea	BIH	
7. CHIRON Alexandra	MDA	
7. CADIGNAN Oriane	FRA	

REPECHAGE

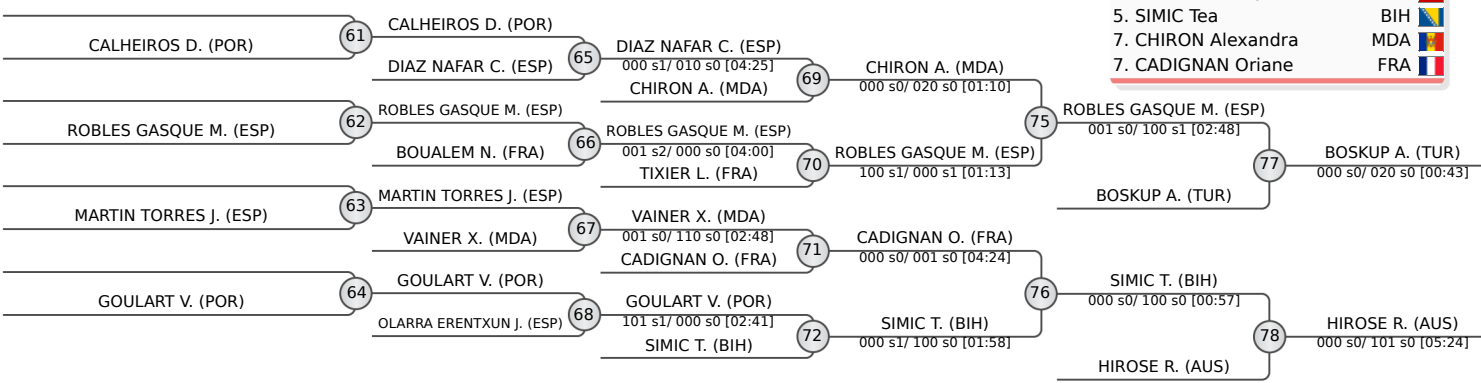



Faro Millennium Team Cadet European Cup 2026

Portugal, Faro/Algarve, 23-24 May 2026

-57 kg

Cadets (38)

POOL A

1	CARAVELLO Lisa (AUS)	33	CARAVELLO L. (AUS)
2	ALCIBAR MARCILLA Carlota (ESP)	001 s3/ 101 s0 [04:41]	100 s0/ 000 s0 [02:14]
3	PALERMO Sara (ITA)		
3	NATARIO Maria (POR)		
4	MATHOUA Ayana (FRA)	34	MATHOUA A. (FRA)
4	MATHOUA A. (FRA)		000 s0/ 101 s0 [00:27]
5	ACTIS Margherita (ITA)		
5	ACTIS M. (ITA)		
6	PARDO MARTINEZ Carmen (ESP)	013 s1/ 000 s2 [04:00]	010 s2/ 000 s1 [04:00]
6	JANSEN Marie-Lise (BEL)		
7	GRUEVA Dara (BUL)	35	GRUEVA D. (BUL)
7	GRUEVA D. (BUL)		
8	DUARTE Ines (POR)	36	GRUEVA D. (BUL)
8	DUARTE I. (POR)		102 s1/ 000 s0 [02:05]

POOL B

9	PEREIRA Gabriela (BRA)	37	PEREIRA G. (BRA)
9	PEREIRA G. (BRA)		101 s0/ 000 s0 [01:59]
10	DANIELE Chiara (ITA)		
10	DANIELE C. (ITA)		
11	FERNANDEZ ARMSTRONG Ela (ESP)		
11	FERNANDEZ ARMSTRONG E. (ESP)		
12	ANTONIO Beatriz (POR)	38	ANTONIO B. (POR)
12	ANTONIO B. (POR)		002 s0/ 012 s2 [04:00]
13	LOURENCO Rita (POR)		
13	LOURENCO R. (POR)		
14	FONTANELL Margaux (FRA)	39	LOURENCO R. (POR)
14	FONTANELL M. (FRA)		012 s0/ 000 s0 [04:00]
15	PORRO Ludovica (ITA)		
15	PORRO L. (ITA)		
16	CRESPO SILVA Carlota (ESP)	40	PORRO L. (ITA)
16	SEICA Ioana (ROU)		010 s0/ 000 s2 [05:03]

POOL C

17	KILIC Elif (TUR)	41	RUSU M. (MDA)
17	KILIC E. (TUR)		000 s0/ 010 s0 [04:38]
18	RUSU Maria (MDA)		
18	RUSU M. (MDA)		100 s0/ 010 s0 [01:58]
19	GUERRERO PADIN Ines (ESP)		
19	FERREIRA Maria (POR)		
20	BELHADI Saliha (FRA)	42	BELHADI S. (FRA)
20	BELHADI S. (FRA)		000 s0/ 101 s2 [01:22]
21	TOPCU Ezgi (TUR)		
21	TOPCU E. (TUR)		
22	FOSSATI Annachiara (ITA)	43	TOPCU E. (TUR)
22	FOSSATI A. (ITA)		010 s2/ 000 s1 [04:00]
23	ALARCAO Matilde (POR)		
23	ALARCAO M. (POR)		
24	ALONSO FERNANDEZ Sara (ESP)	44	ALONSO FERNANDEZ S. (ESP)
24	ALONSO FERNANDEZ S. (ESP)		000 s0/ 100 s0 [00:49]

POOL D

25	CHERNOVA Carina (POR)	45	MAGNANI M. (ITA)
25	CHERNOVA C. (POR)		000 s0/ 100 s0 [00:00]
26	MAGNANI Mia (ITA)		
26	MAGNANI M. (ITA)		
27	RENARD Jade (FRA)	46	RENARD J. (FRA)
27	RENARD J. (FRA)		021 s0/ 000 s0 [01:35]
28	TEZANOS CLAVERO Teresa Lourdes (ESP)		
28	ABU JAHRUR Ines (BEL)		
29	DOLZA Giulia (ITA)	47	DOLZA G. (ITA)
29	DOLZA G. (ITA)		001 s0/ 000 s2 [04:00]
30	GILA TORMO Dara (ESP)		
30	GILA TORMO D. (ESP)		
31	SIMIC Mia (BIH)	48	SANS GARCIA E. (FRA)
31	SIMIC M. (BIH)		000 s2/ 100 s1 [06:48]
32	SILVA Julia (POR)		
32	SANS GARCIA E. (FRA)		

REPECHAGE

61	PALERMO S. (ITA)	65	MATHOUA A. (FRA)
61	PALERMO S. (ITA)		000 s1/ 100 s1 [02:03]
62	DANIELE C. (ITA)	66	DANIELE C. (ITA)
62	DANIELE C. (ITA)		100 s0/ 000 s0 [01:00]
63	FERREIRA M. (POR)	67	RUSU M. (MDA)
63	FERREIRA M. (POR)		000 s0/ 100 s0 [00:15]
64	SIMIC M. (BIH)	68	DOLZA G. (ITA)
64	SIMIC M. (BIH)		000 s2/ 100 s2 [05:38]
		69	MATHOUA A. (FRA)
			100 s1/ 001 s2 [02:53]
		70	LOURENCO R. (POR)
			000 s2/ 001 s0 [04:41]
		71	ALONSO FERNANDEZ S. (ESP)
			000 s1/ 101 s0 [02:30]
		72	DOLZA G. (ITA)
			100 s0/ 000 s0 [00:12]

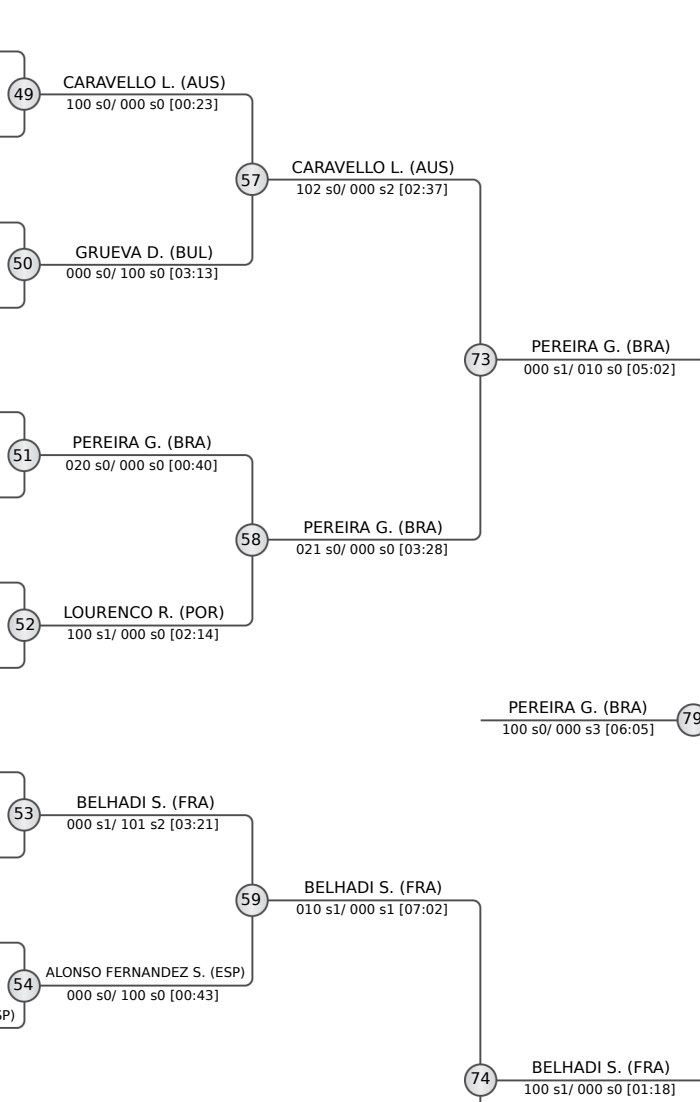

FINAL RESULTS	
1.	PEREIRA Gabriela (BRA)
2.	BELHADI Saliha (FRA)
3.	LOURENCO Rita (POR)
3.	CARAVELLO Lisa (AUS)
5.	SANS GARCIA Emmy (FRA)
5.	ALONSO FERNANDEZ Sara (ESP)
7.	MATHOUA Ayana (FRA)
7.	DOLZA Giulia (ITA)



Faro Millennium Team Cadet European Cup 2026

Portugal, Faro/Algarve, 23-24 May 2026

-63 kg

Cadets (35)

POOL A

	MAIA Manuela	BRA	1
	TEIXEIRA Telma	POR	2
	ZUPPARDI Alice	ITA	3
	AMADOR GAVINO Marina	ESP	4
	GONZALEZ ROMANILLOS Leyre	ESP	5
	BARNOIN Emmie	FRA	6
	SABINO Margarida	POR	7
	MATUSZEKOVA Petra	SVK	8

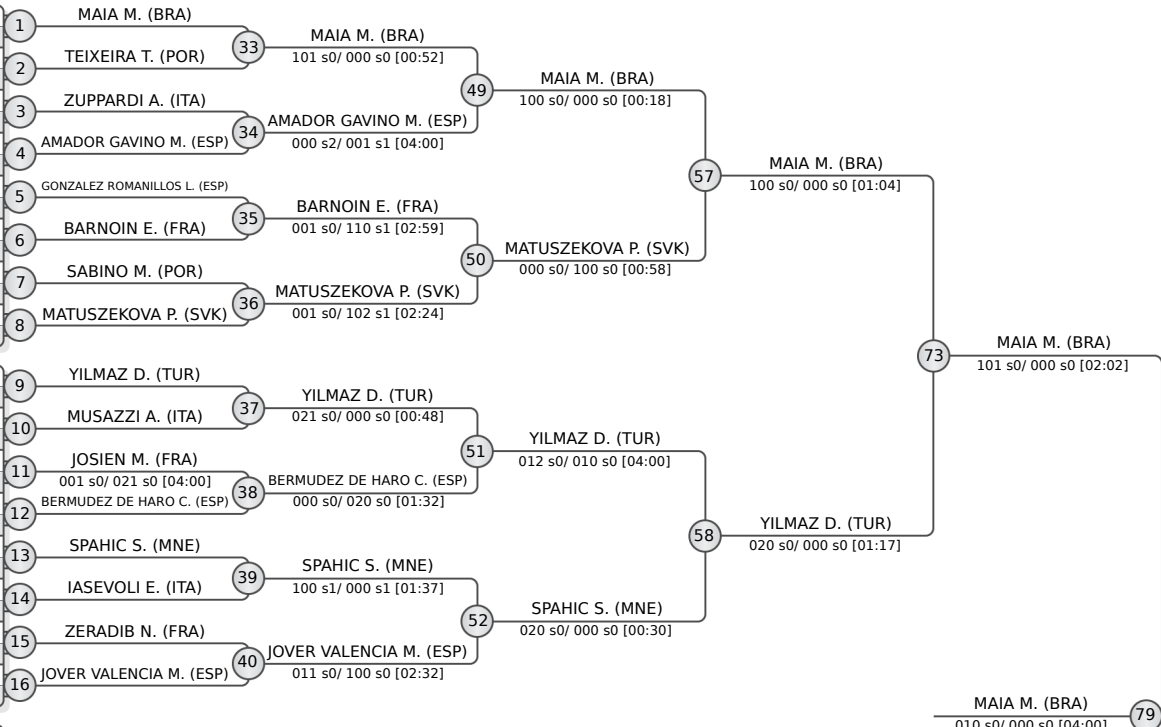

POOL B

	YILMAZ Duru	TUR	9
	MUSAZZI Asia	ITA	10
	CALDEIRA Matilde	POR	11
	JOSIEN Mathilde	FRA	12
	BERMUDEZ DE HARO Celia	ESP	13
	SPAHIC Sejla	MNE	14
	IASEVOLI Emma	ITA	15
	ZERADIB Nesrine	FRA	16
	JOVER VALENCIA Maria	ESP	17

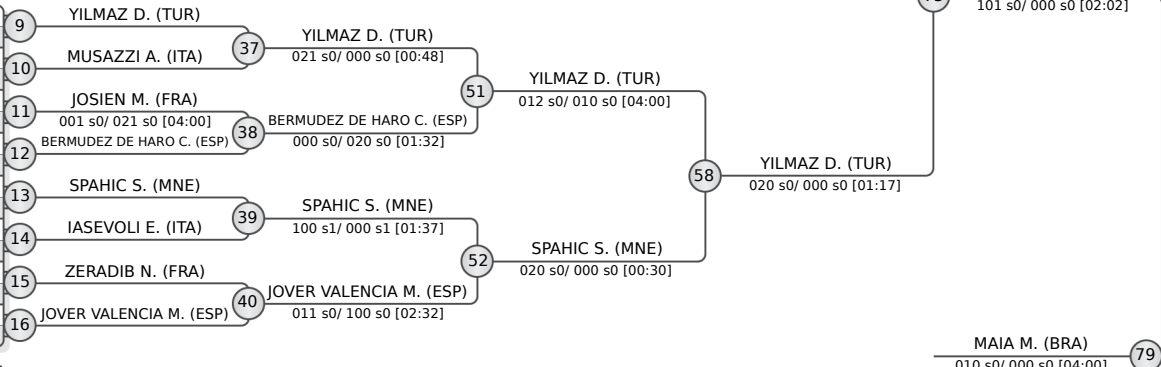

POOL C

	BILEN Sevim Margaret	TUR	17
	CRISOSTOMO Joana Filipa	POR	18
	DAFREVILLE Luane	FRA	19
	DANISOVA Ema	SVK	20
	AURIN LLERINS Martina	ESP	21
	GONCALVES Julia	BRA	22
	ALMEIDA Ines	POR	23
	STALLONE Mariarosa	ITA	24
	CARRASCO GARCIA Claudia	ESP	25

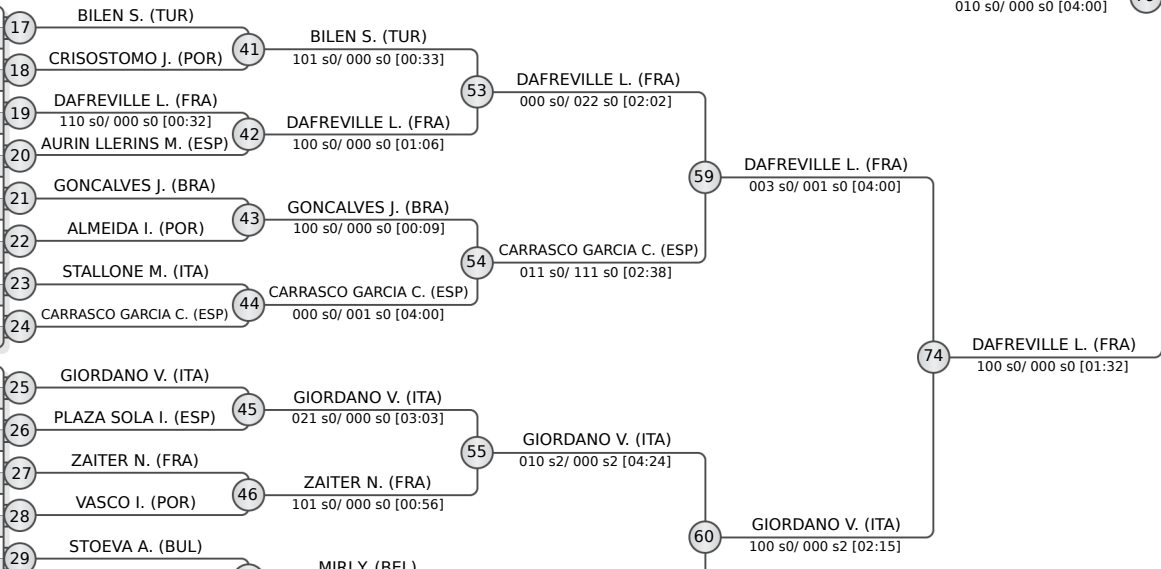

POOL D

	GIORDANO Valeria	ITA	25
	PLAZA SOLA Irene	ESP	26
	ZAITER Nelle	FRA	27
	VASCO Ines	POR	28
	STOEVA Andrea	BUL	29
	MIRI Yasmine	BEL	30
	ROITBERG Emma	ITA	31
	CORTE-REAL Sofia	POR	32
	GARCIA MONTES Judith Eloisa	ESP	33



FINAL RESULTS		
1.	MAIA Manuela	BRA
2.	DAFREVILLE Luane	FRA
3.	SPAHIC Sejla	MNE
3.	YILMAZ Duru	TUR
5.	GIORDANO Valeria	ITA
5.	BILEN Sevim Margaret	TUR
7.	MATUSZEKOVA Petra	SVK
7.	ROITBERG Emma	ITA

REPECHAGE

TEIXEIRA T. (POR)	61	TEIXEIRA T. (POR)	61
MUSAZZI A. (ITA)	62	MUSAZZI A. (ITA)	62
DANISOVA E. (SVK)	63	DANISOVA E. (SVK)	63
AURIN LLERINS M. (ESP)	64	AURIN LLERINS M. (ESP)	64
PLAZA SOLA I. (ESP)	64	PLAZA SOLA I. (ESP)	64

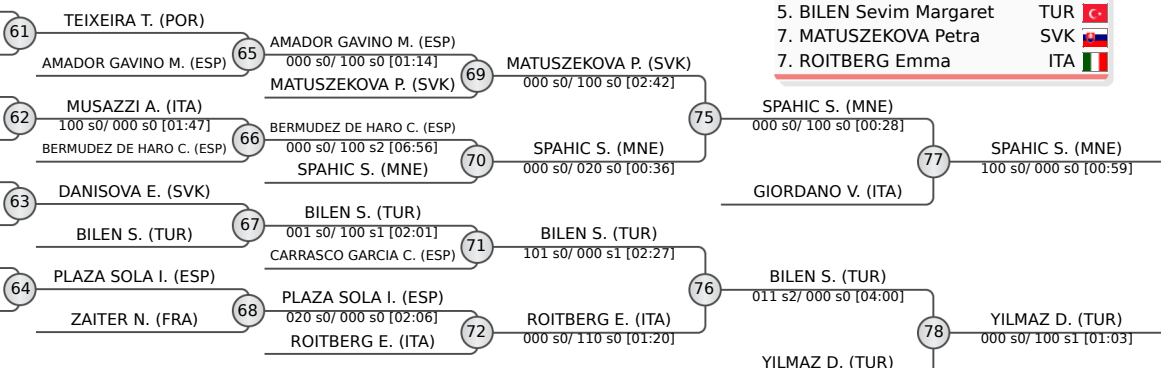



Faro Millennium Team Cadet European Cup 2026

Portugal, Faro/Algarve, 23-24 May 2026

-70 kg

Cadets (26)

POOL A

	TOMBOU Valerie	BEL
	FAGIANO Clara	ITA
	FERRER LOPEZ Adriana	ESP
	ILIASOVA Emilia	SVK
	WANDJI NJIOTANG Marie Emmanuelle	FRA
	MERA CARMONA Aitana	ESP
	GIL LEITAO Madalena	POR

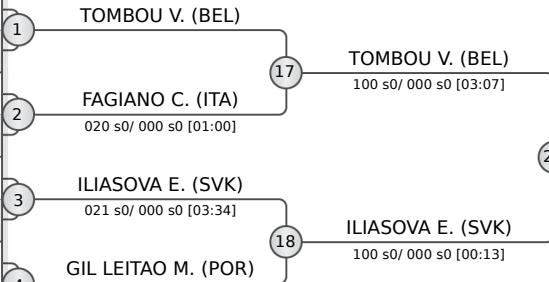

POOL B

	GUIRAL Emma	FRA
	DURA DOCON Sofia	ESP
	MEDA Ines	POR
	RESENDE Maria	BRA
	ROUX Maelys	FRA
	DEMETERCO Valentina	BRA

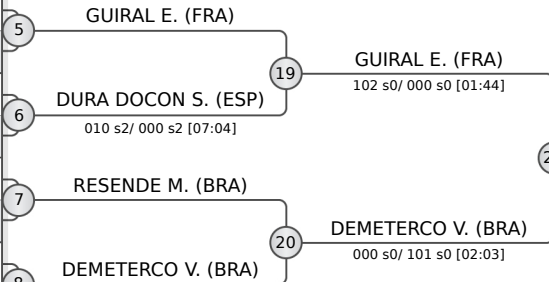

POOL C

	MOREIRA Joana	POR
	OLIVEIRA Alicia	BRA
	BAUDCHON Enora	FRA
	CAFARO Ginevra Margherita Pia	ITA
	GONZALEZ LORIENTE Martina	ESP
	LOUREIRO Maria	POR
	BENRAHAL Alya	FRA

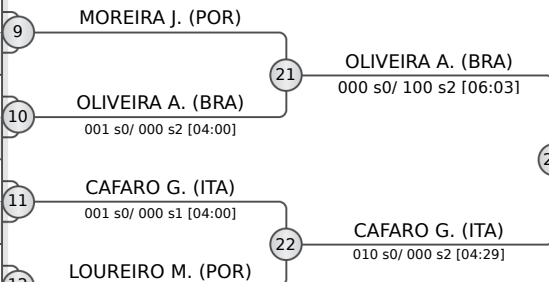

POOL D

	OZBUDAK Done Melike	TUR
	FRAILE LONGUEIRA Sara	ESP
	LE BARS Maelysse	FRA
	MBENGUE RUANO Deguene Aisha	ESP
	ZOLEZZI Noemi	ITA
	GOMES Erica	POR

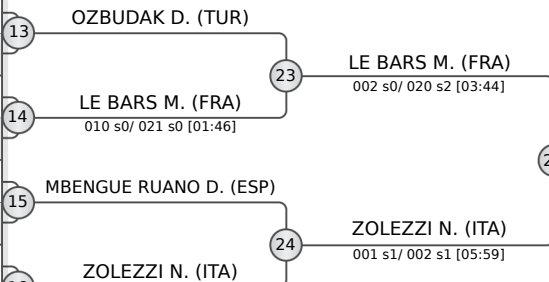

REPECHAGE

FAGIANO C. (ITA)	29	FAGIANO C. (ITA)	33
ROUX M. (FRA)		ILIASOVA E. (SVK)	
RESENDE M. (BRA)	30	ROUX M. (FRA)	34
GONZALEZ LORIENTE M. (ESP)		GUIRAL E. (FRA)	
LOUREIRO M. (POR)	31	LOUREIRO M. (POR)	35
GOMES E. (POR)		OLIVEIRA A. (BRA)	
MBENGUE RUANO D. (ESP)	32	MBENGUE RUANO D. (ESP)	36
		LE BARS M. (FRA)	

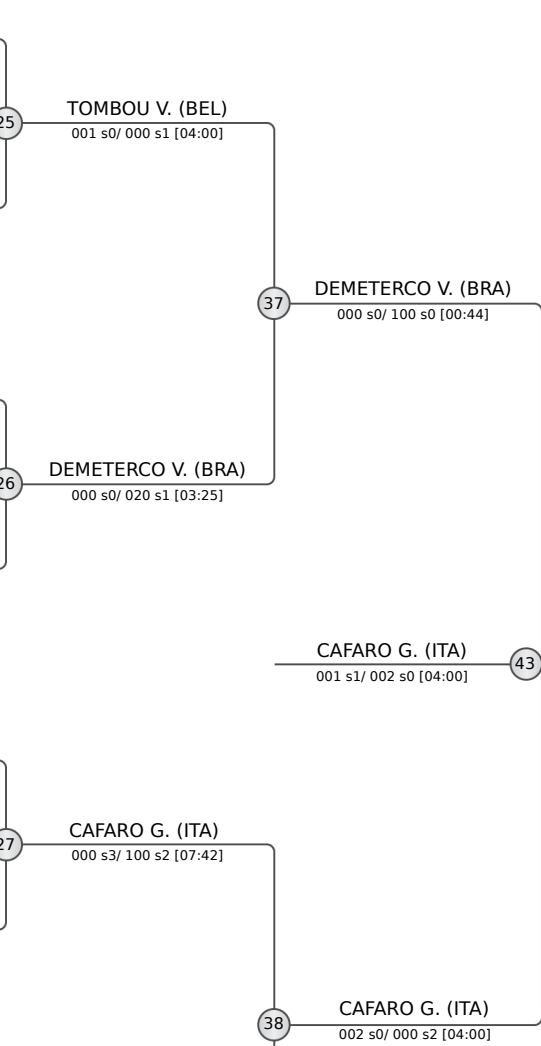
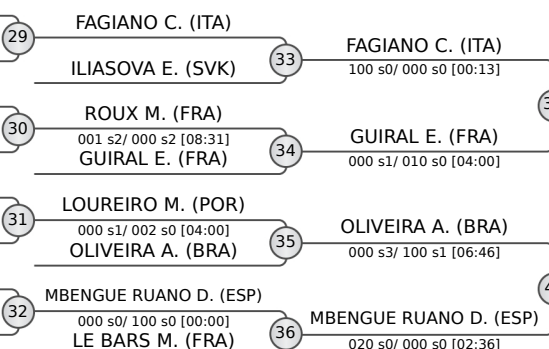

FINAL RESULTS		
1.	CAFARO Ginevra Margherita Pia	ITA
2.	DEMETERCO Valentina	BRA
3.	FAGIANO Clara	ITA
3.	TOMBOU Valerie	BEL
5.	ZOLEZZI Noemi	ITA
5.	OLIVEIRA Alicia	BRA
7.	GUIRAL Emma	FRA
7.	MBENGUE RUANO Deguene Aisha	ESP





Faro Millennium Team Cadet European Cup 2026

Portugal, Faro/Algarve, 23-24 May 2026

+70 kg

Cadets (21)

POOL A

	BALCI Hatice Tuana	TUR
	REHOUNI Amina	FRA
	CUBRILO Tamara	SRB
	TOLEDO Yasmim	BRA
	QUINTELA MORANTE Jimena	ESP
	ALVES Matilde Lopes	POR

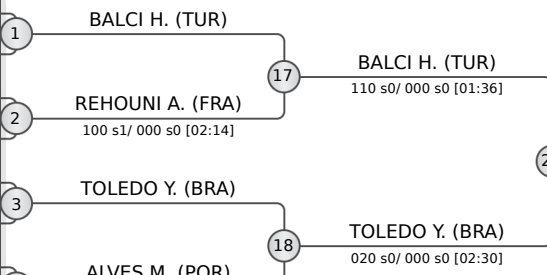

POOL B

	CHERKELIEVA Maria	BUL
	ORTIZ MURCIA Silvia	ESP
	MORGADO Mariana	POR
	MAGASSA FOFANA Sogona	ESP
	MAFRA Isabelle	BRA

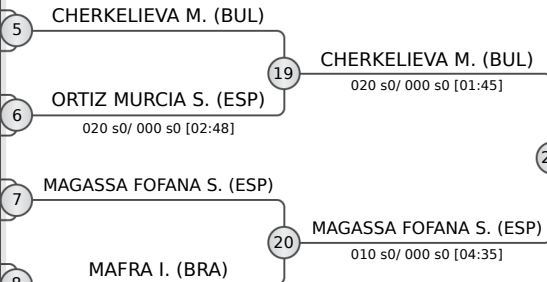

POOL C

	OHONISHI Caroline	BRA
	JANUARIO RODRIGUEZ Antia	ESP
	PAIXAO Agatha	BRA
	BARREIRA Beatriz	POR
	GNON Jennifer	FRA

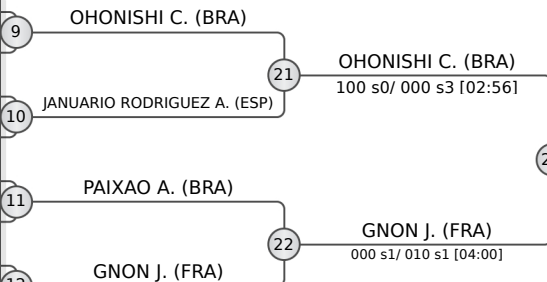

POOL D

	COULIBALY TOURE Ballalo	ESP
	VUIJSTERS Vanessa	NOR
	PALERMO Elisa	ITA
	DOUALA Perle	FRA
	MANE Iara	POR

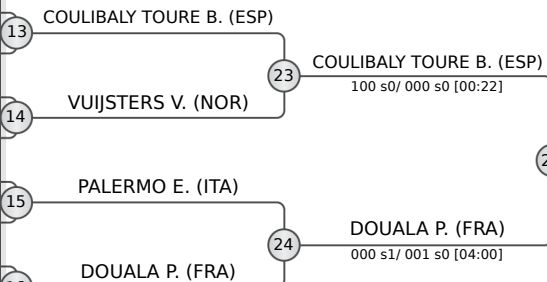

REPECHAGE

ALVES M. (POR) (29)	ALVES M. (POR) (29)
ORTIZ MURCIA S. (ESP) (30)	ORTIZ MURCIA S. (ESP) (30)
BARREIRA B. (POR) (31)	PAIXAO A. (BRA) (31)
PAIXAO A. (BRA) (31)	PAIXAO A. (BRA) (31)
VUIJSTERS V. (NOR) (32)	VUIJSTERS V. (NOR) (32)

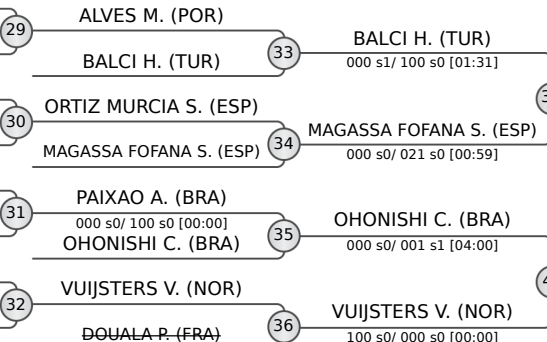

TOLEDO Y. (BRA) (43) [110 s1/ 000 s0 [02:24]]

COULIBALY TOURE B. (ESP) (38) [000 s0/ 020 s0 [01:11]]

FINAL RESULTS

- TOLEDO Yasmim (BRA)
- COULIBALY TOURE Ballalo (ESP)
- BALCI Hatice Tuana (TUR)
- OHONISHI Caroline (BRA)
- GNON Jennifer (FRA)
- CHERKELIEVA Maria (BUL)
- MAGASSA FOFANA Sogona (ESP)
- VUIJSTERS Vanessa (NOR)

