

XXVII INTERNATIONAL JUDO TOURNAMENT FOR MEN AND WOMEN "OSVOBOZHDENIE" SOFIA 31.1. - 1.II. 1998

GR I CAT. 52 KG. WOMEN / MEN

A	1	DESISLAVA GRONEVA	BUL
	17	FILIZMOZER SABRINA	AUT
	25	SEKULITCH IVANA	YUG
	21	TASESKA RENATA	FUROM
	29		

B	1	STELA LAZAROVA	BUL
	19	OXANA KORZAKOVA	RUS
	21	AUDRY COPPENS	NED
	23		
	15		
	31		

GR II

C	2	MILENA HRISTOVA	BUL
	18	GULIZAR AKAR	TUR
	10	SKARLET TOOLEN	NED
	26	POULOPOULOU KALIROI	GRE
	6		
	22		
	14		
	30		

D	4	NELY DJERMANOVA	BUL
	20	MATSUMI ITO	JPN
	12	SCHERTHANER YVONE	AUT
	28		
	8		
	24		
	16		
	32		

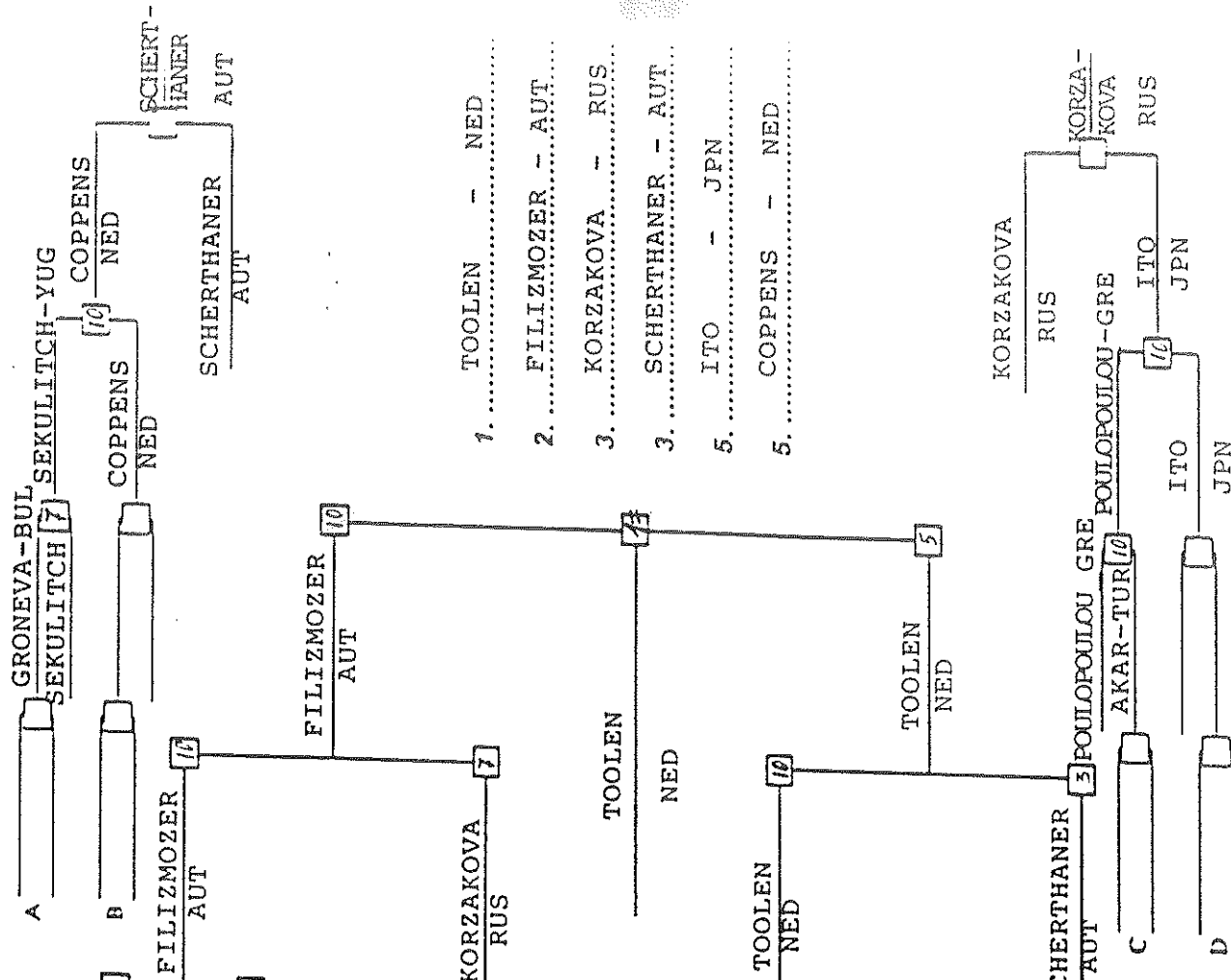

1. TOOLEN - NED
2. FILIZMOZER - AUT
3. KORZAKOVA - RUS
3. SCHERTHANER - AUT
5. ITO - JPN
5. COPPENS - NED

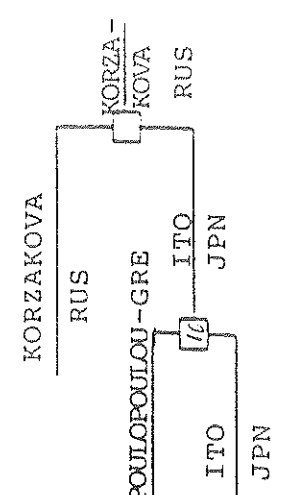

XXVII INTERNATIONAL JUDO TOURNAMENT FOR MEN AND WOMEN "OSVODAZHDENIE" SOFIA J.I. - I.II. 1998

57 CAT. KG. WOMEN / MEN

GR I	17	RIKA TOBISAKI	JPN
A	9	TAMARA DZALAEVA	RUS
	25	PALIVOU ELENI	GRE
	21	VIOLETA TODOROVA	BUL
	29		

B	1	NASE YAZICI	TUR
	19	STANISLAVA ATANASSOVA	BUL
	27	MADL BIRGIT	AUT
	21		
	15		
	31		

GR II	2	NIKITINA ANNA	UKR
C	18	IVELINA TZVETKOVA	BUL
	26	DOUSI M	NED
	22	ELITSA RUJEVA	BUL
	14		
	30		

D	4	POULOPOULOU ERIFILI	GRE
	20	ISKRA STANTICHEVA	BUL
	28	RINERTHALER ALEXANDRA	AUT
	24		
	16		
	32		

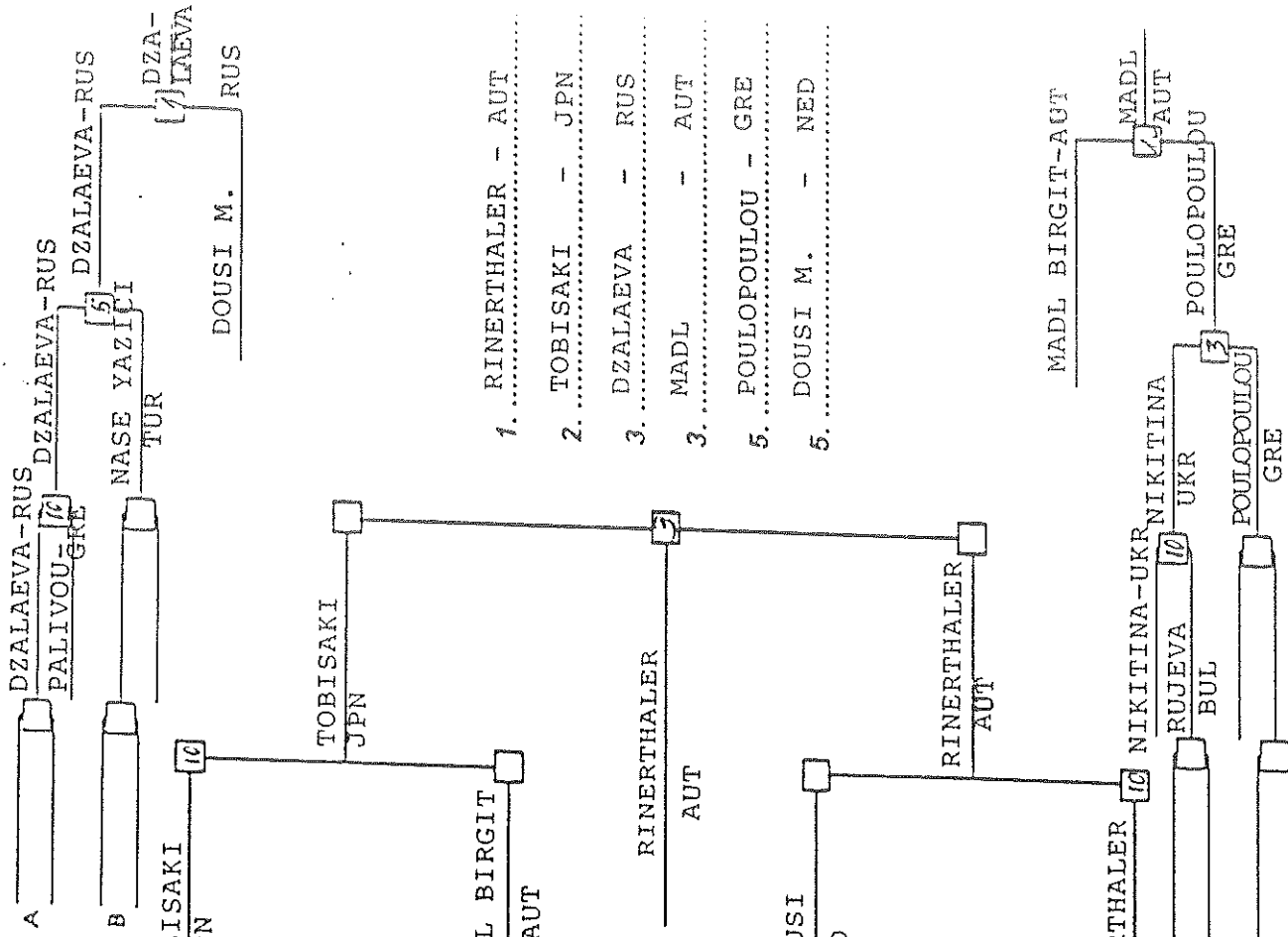

1. RINERTHALER - AUT
2. TOBISAKI - JPN
3. DZALAEVA - RUS
3. MADL - AUT
5. POULOPOULOU - GRE
5. DOUSI M. - NED

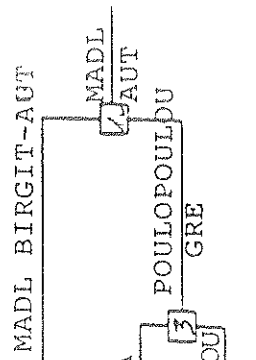

XXVII INTERNATIONAL JUDO TOURNAMENT FOR MEN AND WOMEN "OSVOBOZHDENIE" SOFIA 31.1. - 1.II. 1998

GR I CAT. 63 KG. WOMEN / MEN
A RIKA ISHII JPN

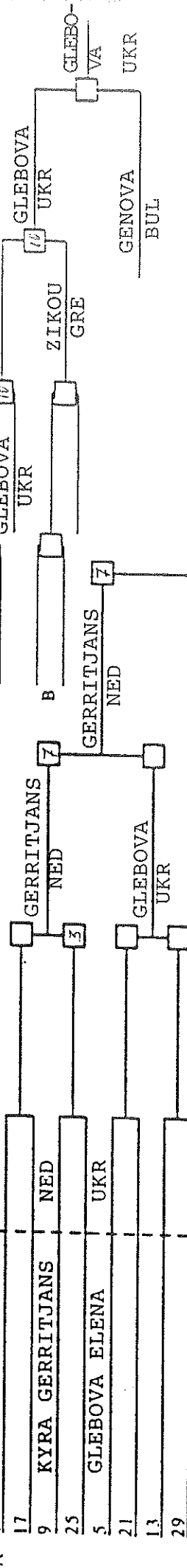

B 3 MILA MARKOVA BUL

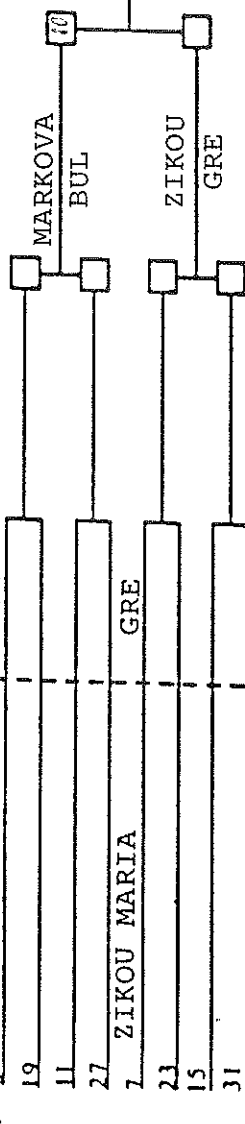

GR II CAT. 63 KG. WOMEN / MEN
C 2 TZVETKOVITCH SLAJANA YUG

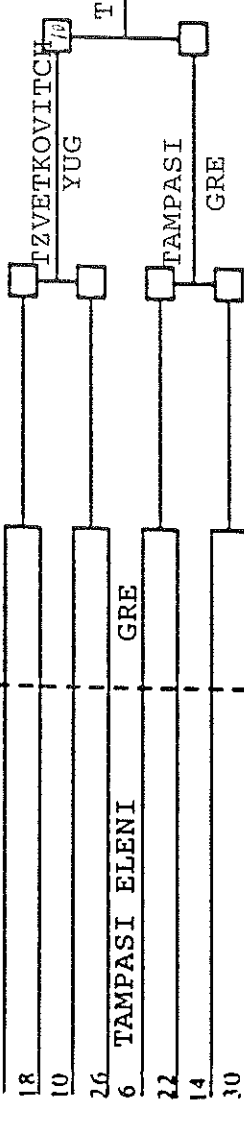

D 4 VESSELINA GENOVA BUL

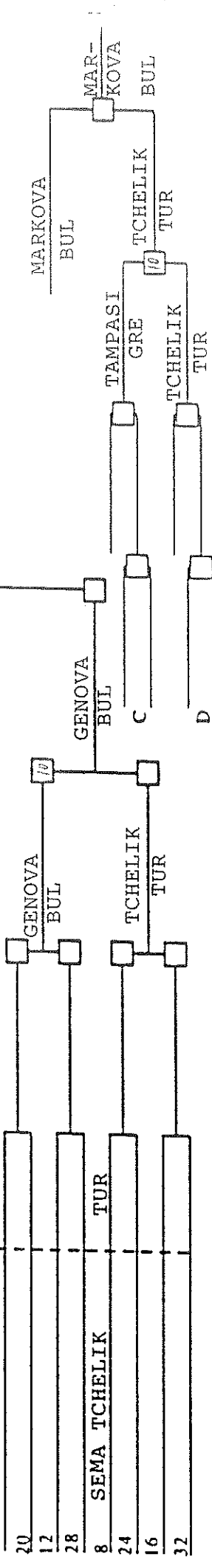

1. GERRITJANS - NED
2. TZVETKOVITCH - YUG
3. GLEBOVA - UKR
3. MARKOVA - BUL
5. GENOVA - BUL
5. TCHVETKOVITCH - TUR

XXVII INTERNATIONAL JUDO TOURNAMENT FOR MEN AND WOMEN "OSYOROZHIDENIE" SOFIA 31.I. - 1.II. 1998

GR I CAT. ...70..... KG. WOMEN / MEN
A YELIZ BOYACI TUR

17	DETELINA PIRDOPSKA	BUL
9	SVETLANA GALIANI	RUS
25	BARDATCHEVA VALENTINA	UKR
5	SCHLAGNITWEIT SILVIA	AUT
21	MARIA MITEVA	BUL
13	AKRITIDOU BARBARA	GRE
29		

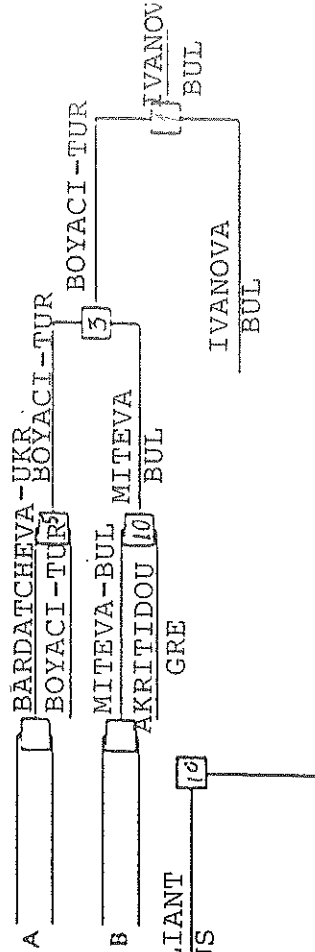

GR II

19	ANGLBERGER ANNELIESE	AUT
11	VALERIA LUKANOVA	BUL
27	KURTELESI ALEXIA	GRE
7	AKRITIDOU BARBARA	GRE
23	NICKY BOONTJE	NED
15		
31		

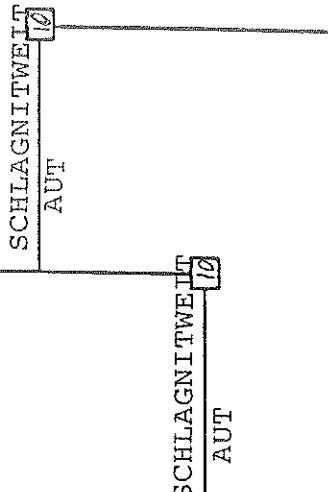

GR III

2	MIRKOVITCH BICJANA	YUG
18	BOEVA SVETLANA	UKR
10	GALINA IVANOVA	BUL
26	ANGLBERGER ANNELIESE	AUT
6	VALERIA LUKANOVA	BUL
22	KURTELESI ALEXIA	GRE
14	NICKY BOONTJE	NED
30		

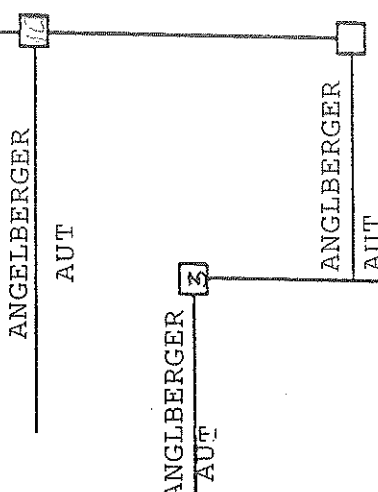

GR IV

4	MIRKOVITCH BICJANA	YUG
20	BOEVA SVETLANA	UKR
12	GALINA IVANOVA	BUL
28	ANGLBERGER ANNELIESE	AUT
8	VALERIA LUKANOVA	BUL
24	KURTELESI ALEXIA	GRE
16	NICKY BOONTJE	NED
32		

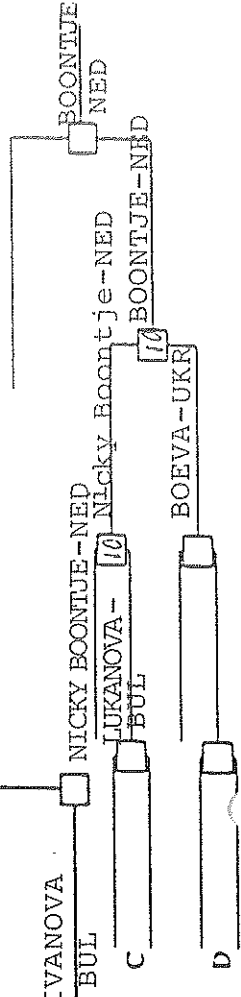

1. ANGELBERGER AUT
2. SCHLAGNITWEIT AUT
3. BOONTJE NED
3. IVANOVA BUL
5. BOJAGI TUR
5.

- BOONTJE NED
- Nicky Boontje - NED
- LUKANOVA - BUL
- BOONTJE - NED
- BOEVA - UKR

XXVII INTERNATIONAL JUDO TOURNAMENT FOR MEN AND WOMEN "OSVOROZHDENIE" SOFIA 31.I. - 1.II. 1998

GR I CAT. 78.....KG. WOMEN / MEN

A	1	ZARIFE YILDERIM	TUR
	17		
	9		
	25		
B	5	PAPADAKI FOTINI	GRE
	21		
	13		
	29		

B 1 EKATERINA HRISTOVA, BUL.

	19		
	11		
	27		
	7		
	21		
	15		
	31		

GR II C 2 MIRANDA BROEK, NED.

	18		
	10		
	26		
	6		
	22		
	14		
	30		

D 4 ASIA ASCHIMOVA, BUL.

	20		
	12		
	28		
	8		
	24		
	16		
	32		

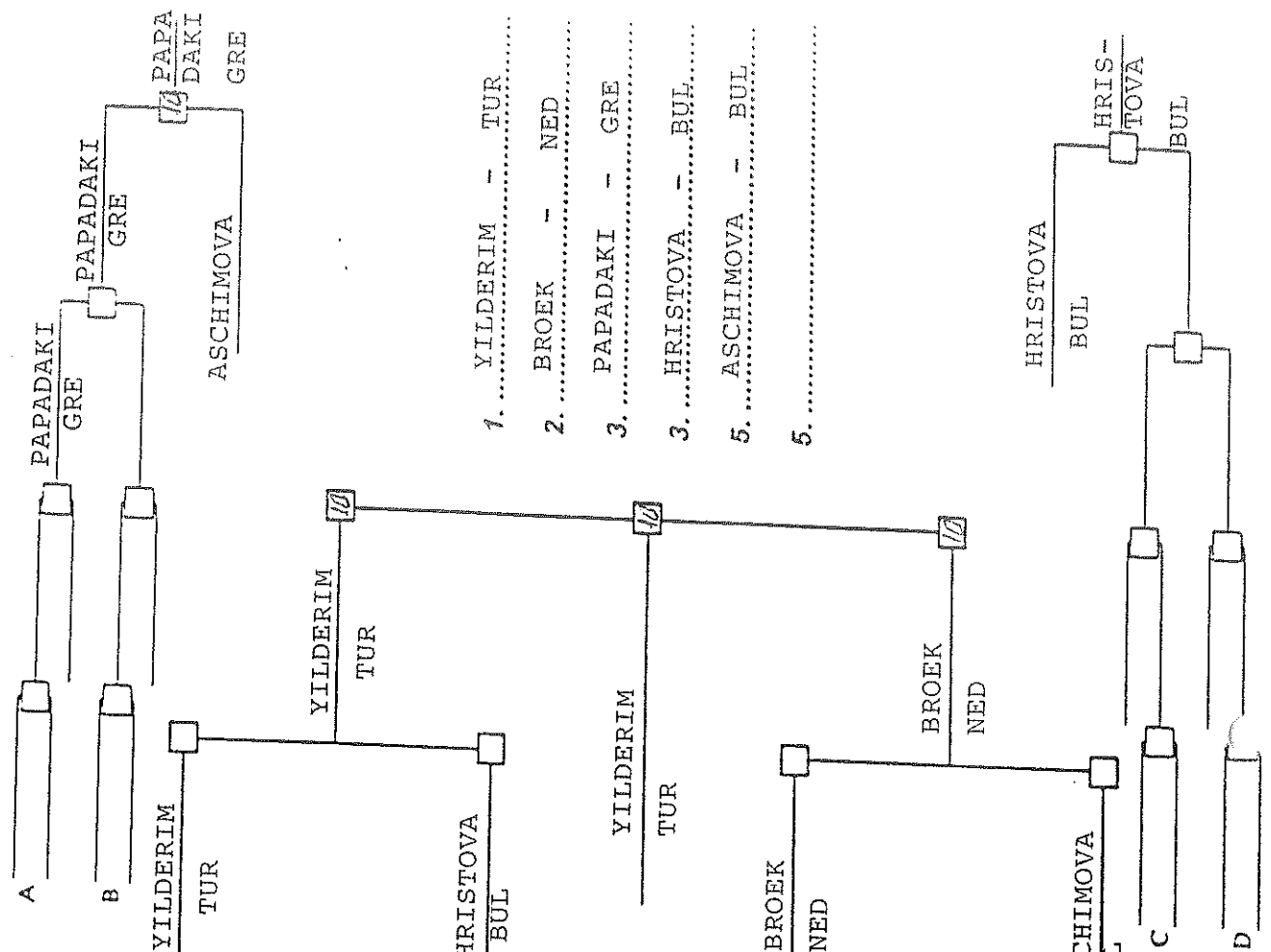

1. YILDERIM - TUR.....
2. BROEK - NED.....
3. PAPADAKI - GRE.....
3. HRISTOVA - BUL.....
5. ASCHIMOVA - BUL.....
5.

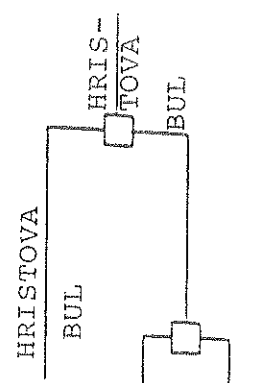

XXVII INTERNATIONAL JUDO TOURNAMENT FOR MEN AND WOMEN "OSVOBOZHENIE" SOFIA 31.1. - 1.01. 1998

GR I CAT. + 78... KG. WOMEN / MEN

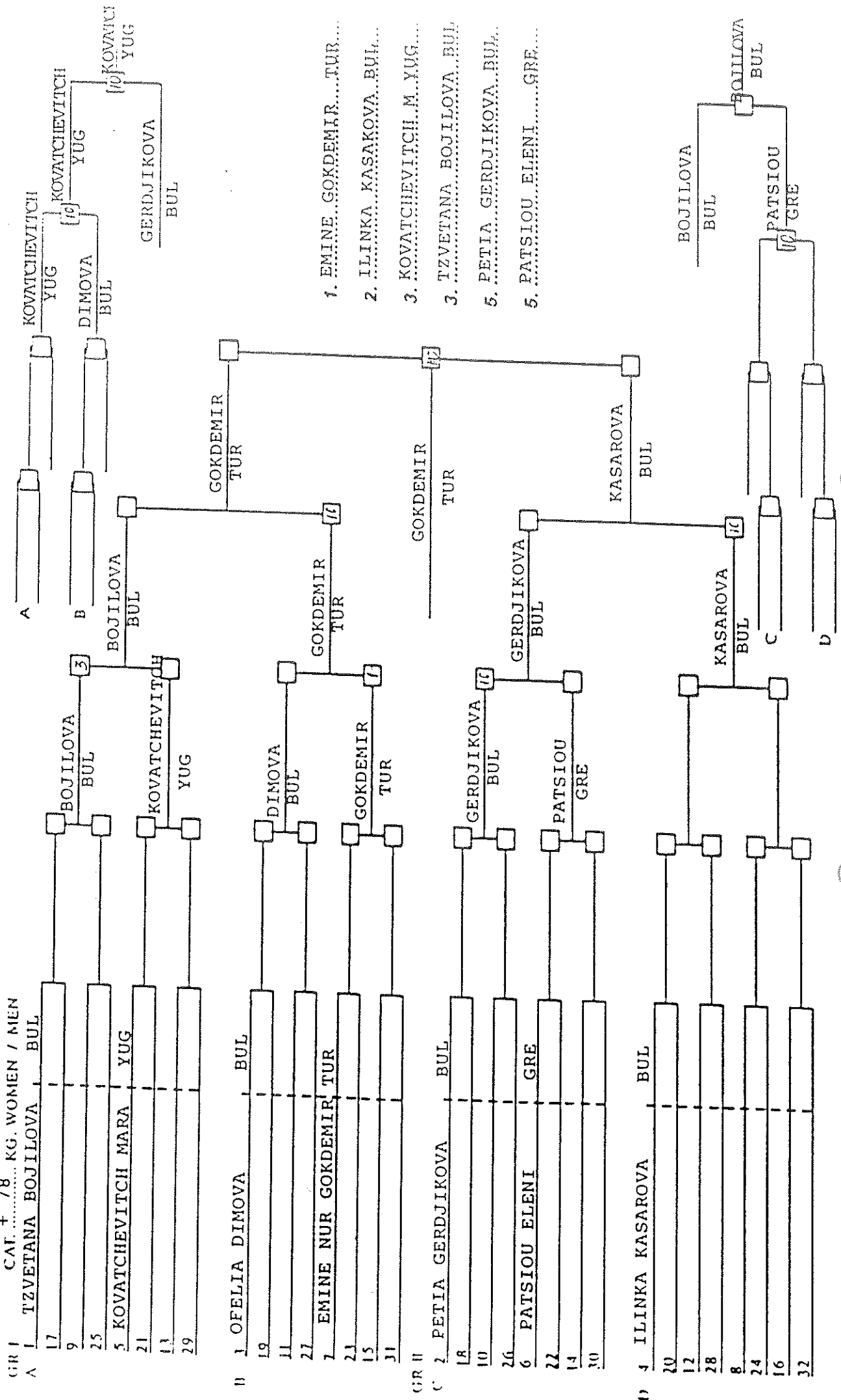

XXVII INTERNATIONAL JUDO TOURNAMENT FOR MEN AND WOMEN "OSVOBOZHDENIE" SOFIA 31.I. - 1.II. 1998

GR I CAT. 60 KG. WOMEN / MEN

1 YOSHINORI SATO JAP

17 IVAN BARZAKOV BUL

25 KIRBICH SACHO SLO

1 ALEXEY MAJOROV RUS

29 BAKYTN VLADIMIR UKR

1 PLAMEN STOIANOV BUL

7 ORLIN RUSSEV BUL

15 ZOURAB CHOULAIY RUS

31 PASKOSKI IGOR FYROM

18 NIKOLAY VRATCHOV BUL

10 SIMAN GUNEY TUR

14 SERGEI ZAKALIAPIN RUS

30 ZAPOCHNIC SIMON SLO

11 BOUNDAKIS DIMITRIOS GRE

28 VENTZISLAV STOIANOV BUL

10 VENZEL GERNOT AUT

11

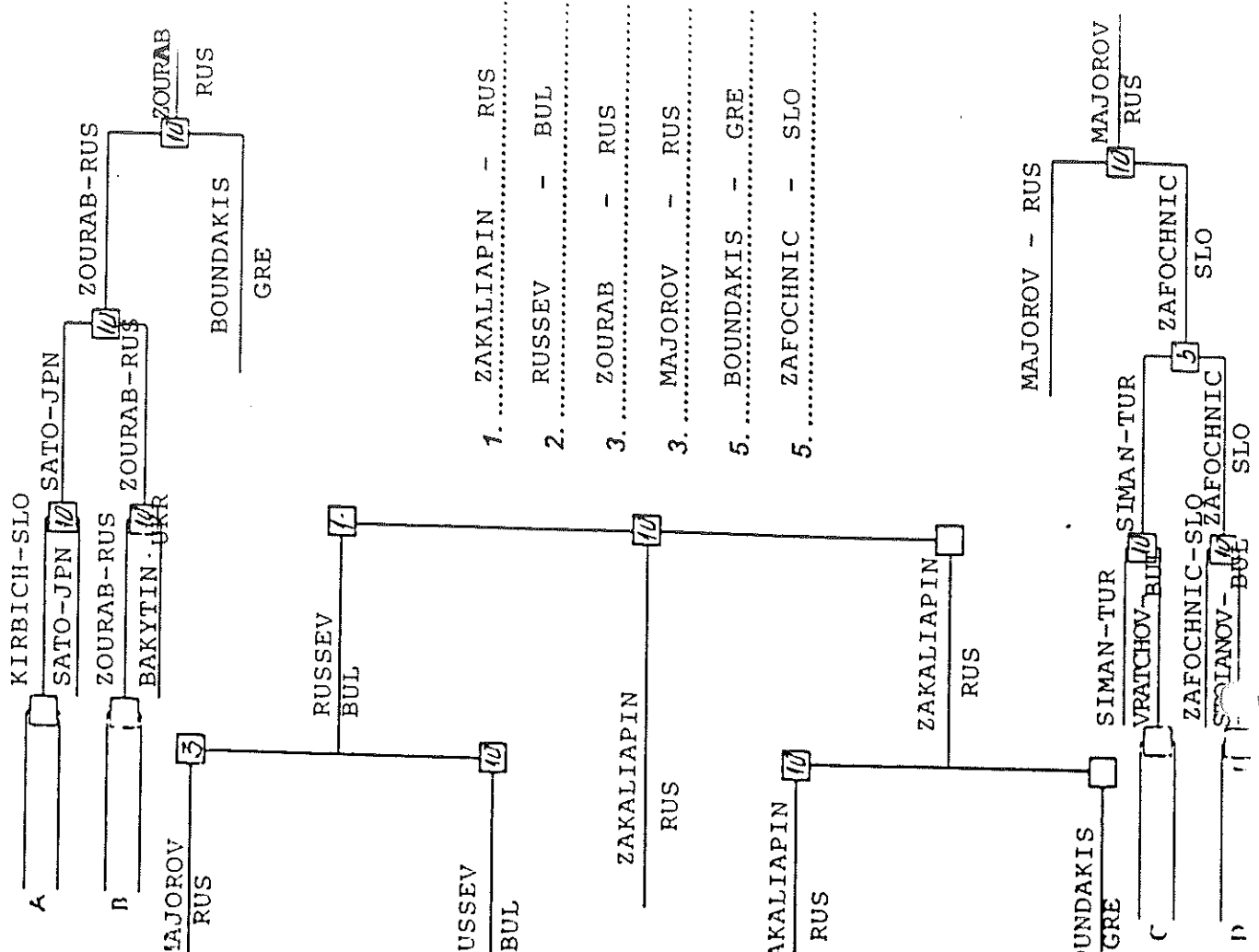

1. ZAKALIAPIN - RUS
2. RUSSEV - BUL
3. ZOURAB - RUS
3. MAJOROV - RUS
5. BOUNDAKIS - GRE
5. ZAPOCHNIC - SLO

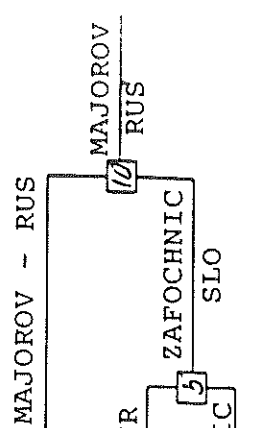

XXVII INTERNATIONAL JUDO TOURNAMENT FOR MEN AND WOMEN "OSVOROZHDENIE" SOFIA 31.I. - 1.II. 1978

66

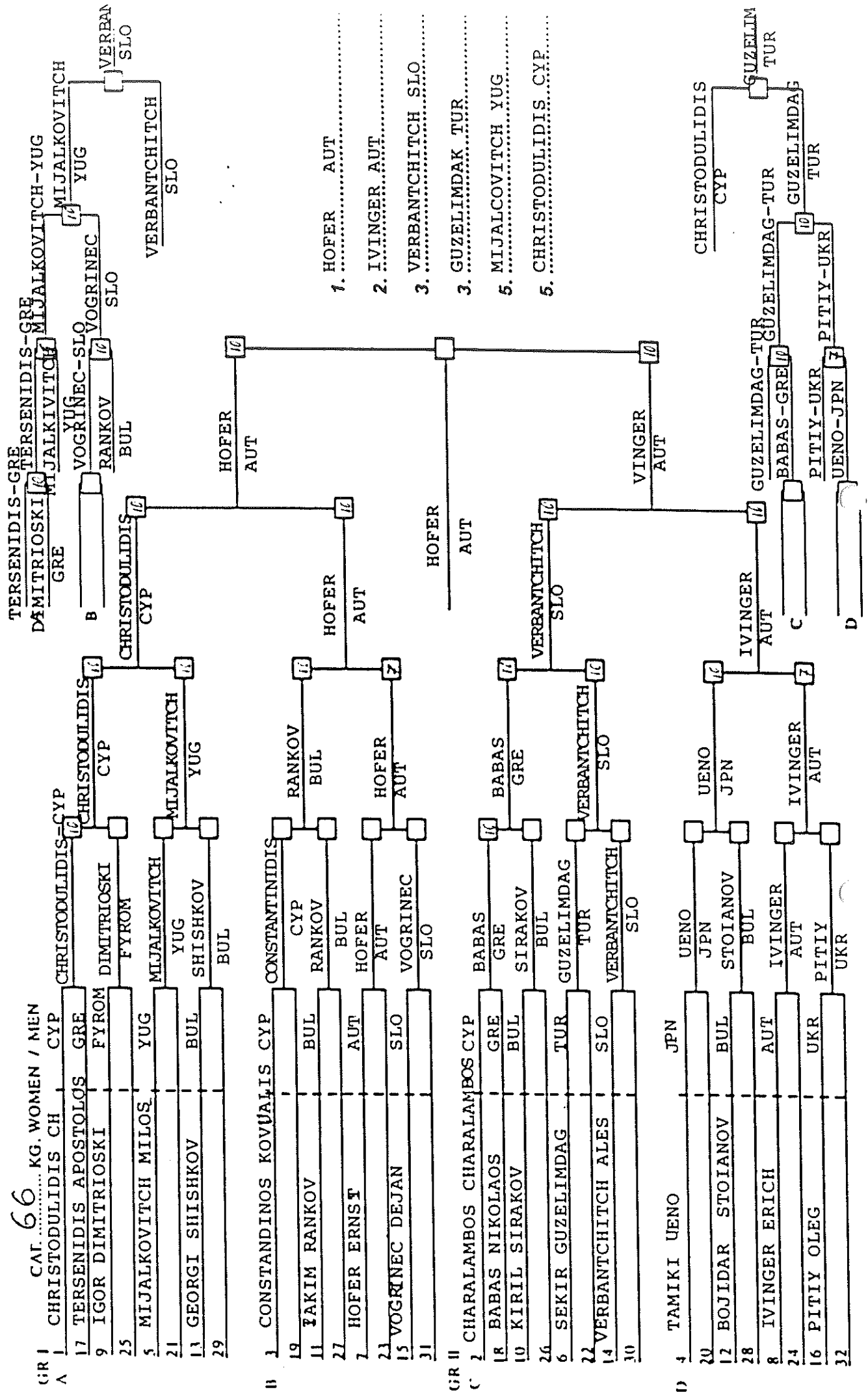

1. HOFER AUT
2. IVINGER AUT
3. VERBANTCHITCH SLO
3. GUZELIMDAK TUR
5. MIJALCOVITCH YUG
5. CHRISTODULIDIS CYP

- | | | |
|------|-------------------------|-------|
| GR I | CHRISTODULIDIS CH | CYP |
| A | CHRISTODULIDIS CH | CYP |
| 17 | TERSENIDIS APOSTOLOS | GRE |
| 9 | IGOR DIMITRIOSKI | FYROM |
| 25 | MIJALKOVITCH MILOS | YUG |
| 5 | MIJALKOVITCH MILOS | YUG |
| 21 | GEORGI SHISHKOV | BUL |
| 13 | GEORGI SHISHKOV | BUL |
| 29 | MIJALKOVITCH MILOS | BUL |
| B | CHRISTODULIDIS CYP | CYP |
| 1 | CONSTANDINOS KOVALIS | CYP |
| 19 | TAKIM RANKOV | BUL |
| 11 | TAKIM RANKOV | BUL |
| 27 | HOFER ERNST | AUT |
| 7 | HOFER ERNST | AUT |
| 23 | VOGRINEC DEJAN | SLO |
| 15 | VOGRINEC DEJAN | SLO |
| 31 | VOGRINEC DEJAN | SLO |
| C | CHARALAMBOS CHARALAMBOS | CYP |
| 8 | BABAS NIKOLAOS | GRE |
| 10 | KIRIL SIRAKOV | BUL |
| 26 | KIRIL SIRAKOV | BUL |
| 6 | SEKIR GUZELIMDAG | TUR |
| 22 | SEKIR GUZELIMDAG | TUR |
| 14 | VERBANTCHITCH ALES | SLO |
| 30 | VERBANTCHITCH ALES | SLO |
| D | TAMIKI UENO | JPN |
| 20 | TAMIKI UENO | JPN |
| 12 | BOJIDAR STOIANOV | BUL |
| 28 | BOJIDAR STOIANOV | BUL |
| 8 | IVINGER ERICH | AUT |
| 24 | IVINGER ERICH | AUT |
| 16 | PITIY OLEG | UKR |
| 32 | PITIY OLEG | UKR |

XXVII INTERNATIONAL JUDO TOURNAMENT FOR MEN AND WOMEN "OSVOBOZHDENIE" SOFIA 31.I. - 1.II. 1998

GR I CAT. 73 KG. WOMEN / MEN, BUL

A	1	ROSEN RUSSEV	BUL
	17		
	9	EVGENI KARPOUHIN	RUS
	25		
	5	JAHODA MARTIN	AUT
	21		
	13		
	29		

B

3	MIHAILOVITCH ZIVAN	YUG
19		
11	ANDREI IGNATENKO	RUS
27		
7	BROD GREGOR	SLO
23		
15		
31		

GR II C

2	TONY RESNJAK	FYROM
18		
10	VALERY MERENKOV	RUS
26		
6	SCOTT TANNER	CAN
22		
14		
30		

D

4	VUITCHITCH SURJAN	YUG
20		
12	SINICHIRO YOKOTA	JPN
28		
8	SALIM ABANOZ	TUR
24		
16		
32		

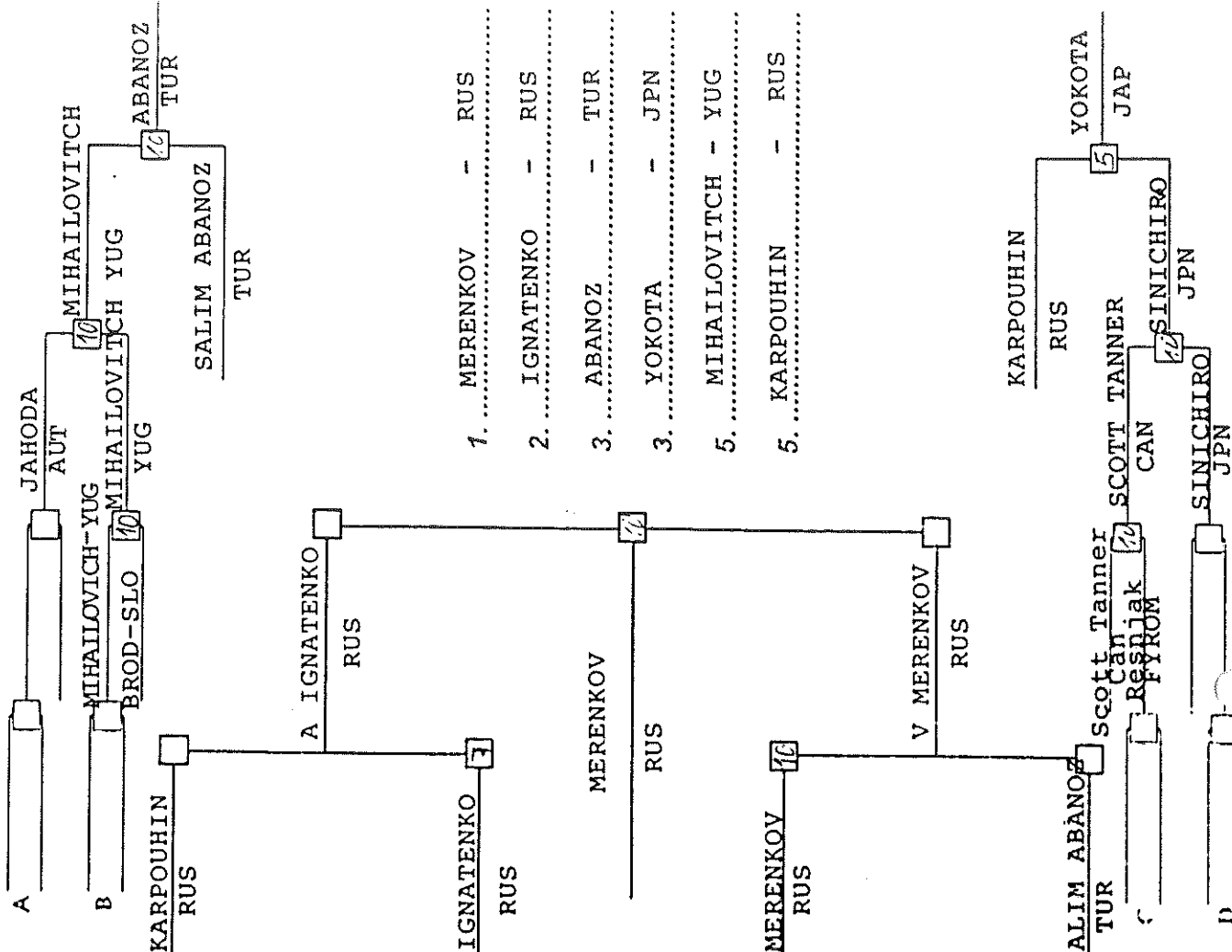

1. MERENKOV - RUS
2. IGNATENKO - RUS
3. ABANOZ - TUR
3. YOKOTA - JPN
5. MIHAILOVITCH - YUG
5. KARPOUHIN - RUS

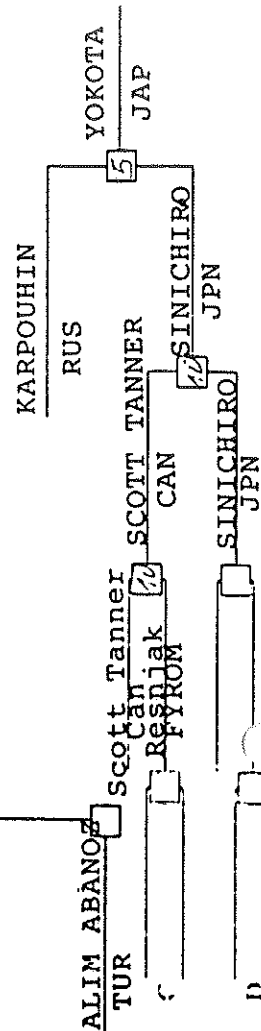

XXVII INTERNATIONAL JUDO TOURNAMENT FOR MEN AND WOMEN "OSVOBOZHDENIE" SOFIA J.I.I. - I.II. 1998

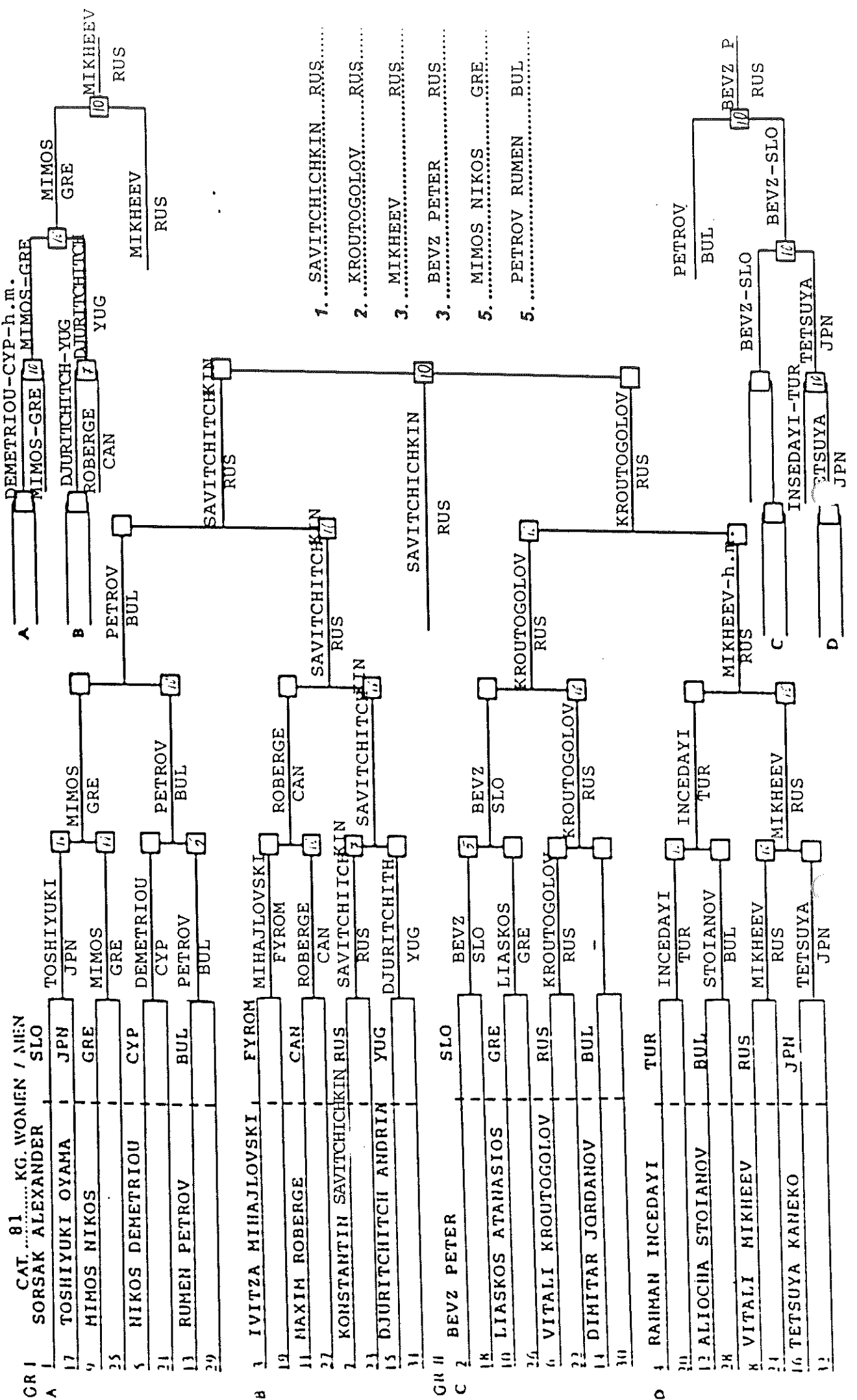

1. SAVITCHICHKIN.....RUS
2. KROUTOGOLOV.....RUS
3. MIKHEEV.....RUS
3. BEVZ PETER.....RUS
5. MIMOS NIKOS.....GRE
5. PETROV RUMEN.....BUL

- PETROV
BUL.
- BEVZ-SLO
RUS
- BEVZ P
RUS
- BEVZ-SLO
RUS
- INSEDAYI-TUR
TUR
- TETSUYA
JPN
- TETSUYA
JPN

XXVII INTERNATIONAL JUDO TOURNAMENT FOR MEN AND WOMEN "OSVOBOZHDENIE" SOFIA 31.1. - 1.II. 1998

GR I CAT. 90 KG. WOMEN / MEN

A	1	DIAN HRISTOV	BUL
	17	HRISTOV	BUL
	9	STOJANOVITCH VLADAN	YUG
	25	STOJANOVITCH	YUG
	5	BORAHAN CAGIRAN	TUR
	21	BORAHAN	TUR
	13	CHRISTOS IOAKIN	CYP
	29	CHRISTOS	CYP

B	1	DIMITAR DOITCHINOV	BUL
	19	DOITCHINOV	BUL
	11	IORDANIDIS ILIAS	GRE
	27	IORDANIDIS	GRE
	7	MANDITCH NEBOISCHA	YUG
	23	MANDITCH	YUG
	15	MANDITCH	YUG
	31	MANDITCH	YUG

C	2	MUSTAFA DJAMBASKI	BUL
	18	DJAMBASKI	BUL
	10	KRAKHMALOV ANDREY	UKR
	26	KRAKHMALOV	UKR
	6	JAHODA ROMAN	AUT
	22	JAHODA	AUT
	14	CHRISTODOULOS ZENIOU	CYP
	30	JAHODA	AUT

D	4	GORAN KOTEV	FYROM
	20	KOTEV	FYROM
	12	BOUNIAS GREGORIOS	GRE
	28	BOUNIAS	GRE
	8	JOCOVIATCH MILOSAV	YUG
	24	JOCOVIATCH	YUG
	16	JOCOVIATCH	YUG
	32	JOCOVIATCH	YUG

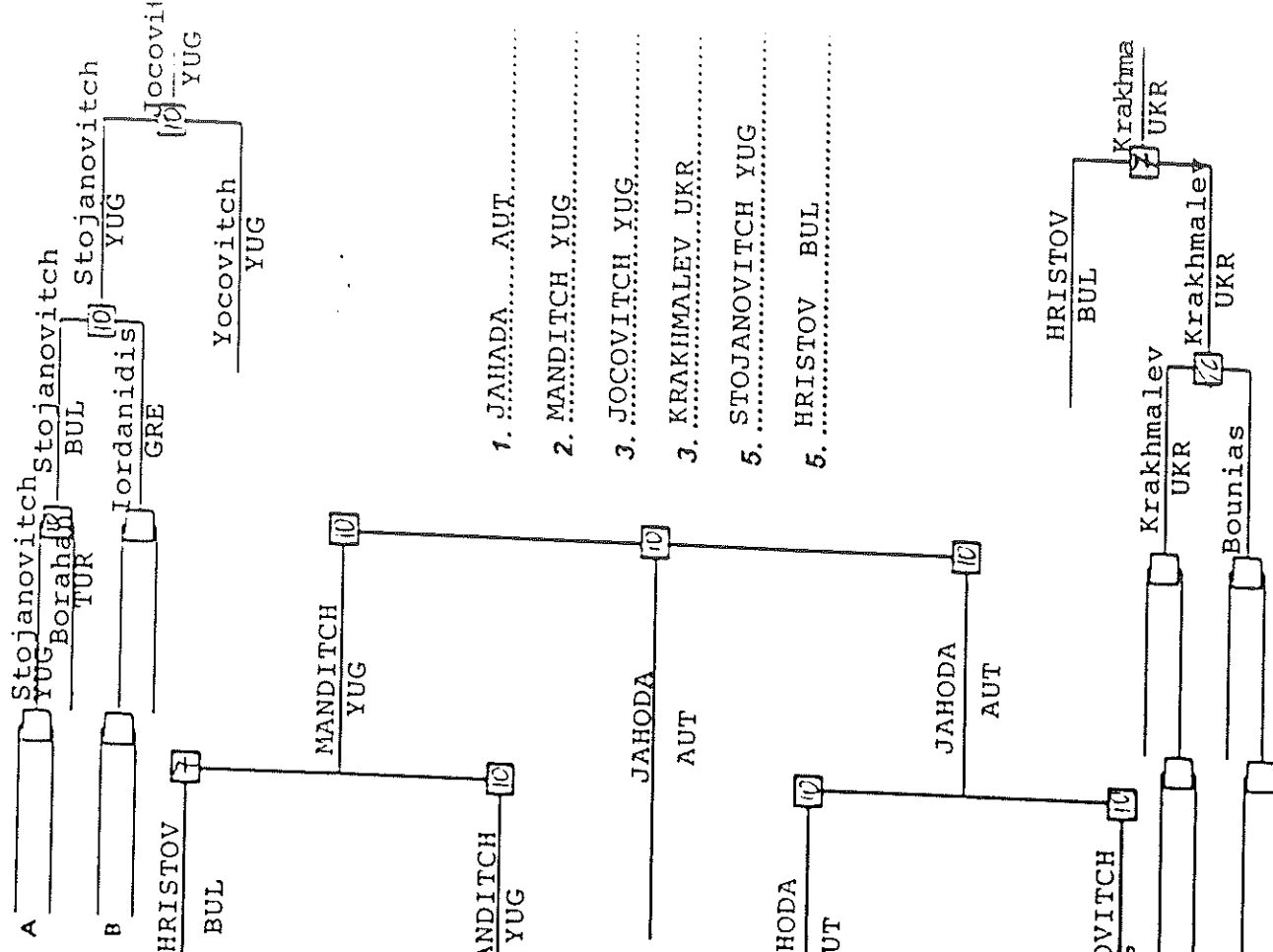

1. JAHODA.....AUT.....
2. MANDITCH YUG.....
3. JOCOVIATCH YUG.....
3. KRAKHMALOV UKR.....
5. STOJANOVITCH YUG.....
5. HRISTOV BUL.....

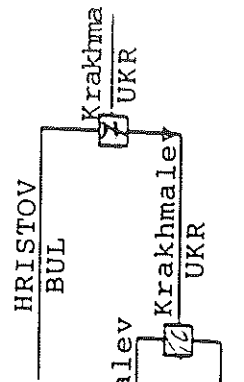

XXVII INTERNATIONAL JUDO TOURNAMENT FOR MEN AND WOMEN "OSVOBOZHDENIE" SOFIA J.I.I. - I.II. 1998

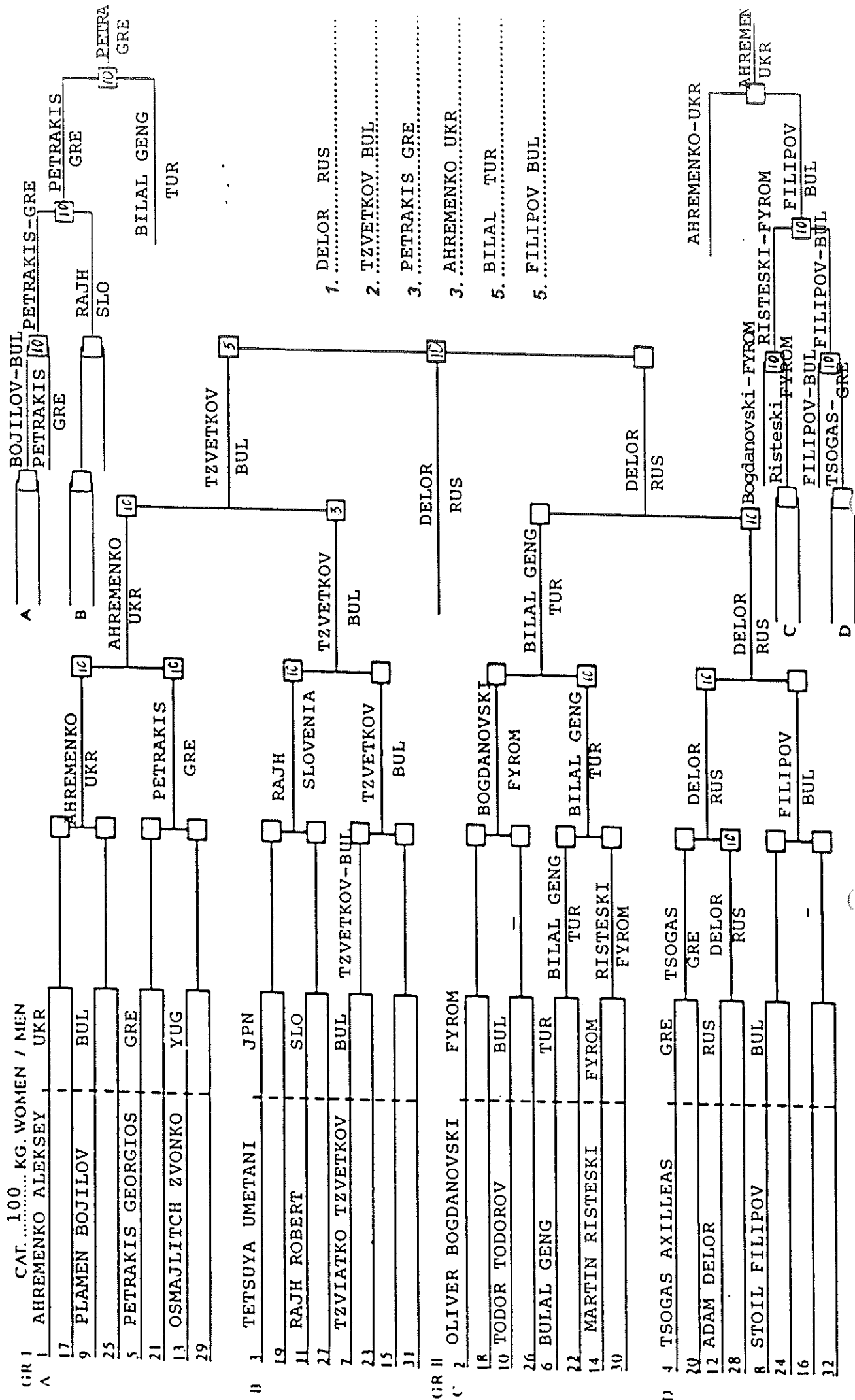

XXVII INTERNATIONAL JUDO TOURNAMENT FOR MEN AND WOMEN "OSVOBOZHDENIE" SOFIA 31.1. - 1.II. 1998

GR I CAT. + 100 KG. WOMEN / MIEN
A I LABUS SINISCHA YUG

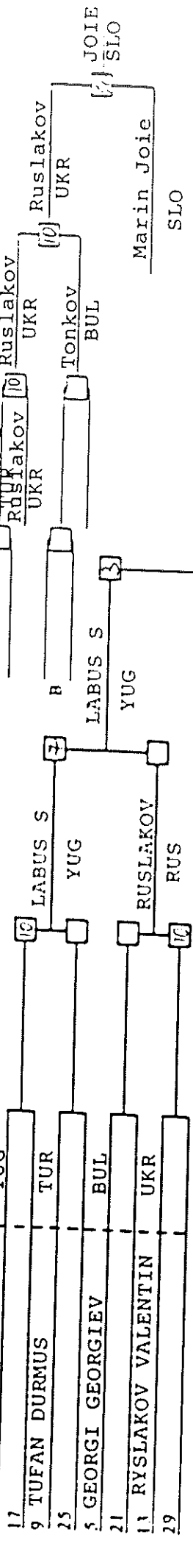

GR II CAT. + 100 KG. WOMEN / MIEN
B I LABUS SINISCHA YUG

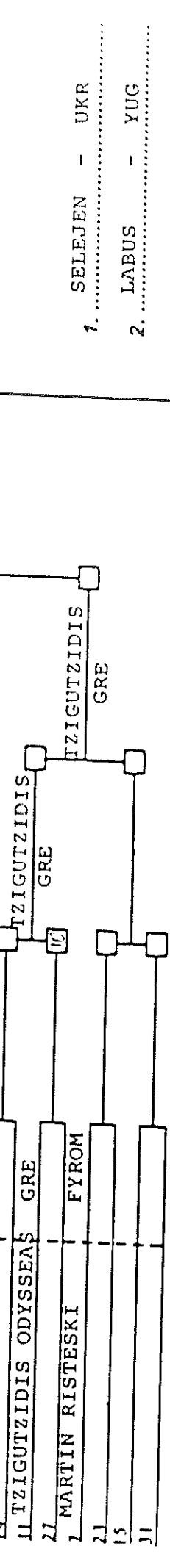

GR III CAT. + 100 KG. WOMEN / MIEN
C I BOJOVITCH OBREN YUG

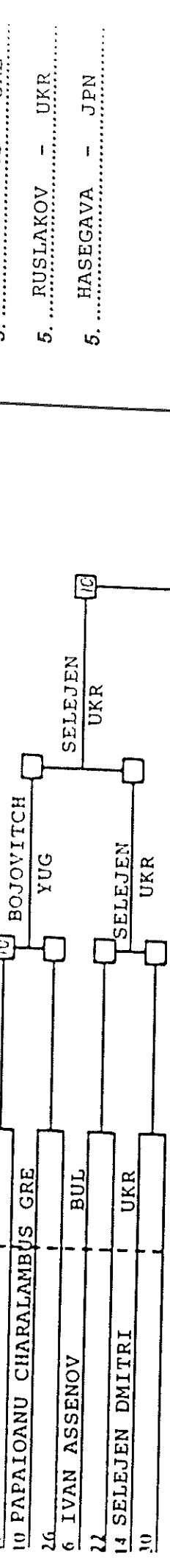

GR IV CAT. + 100 KG. WOMEN / MIEN
D I SPAS KARADJOV BUL

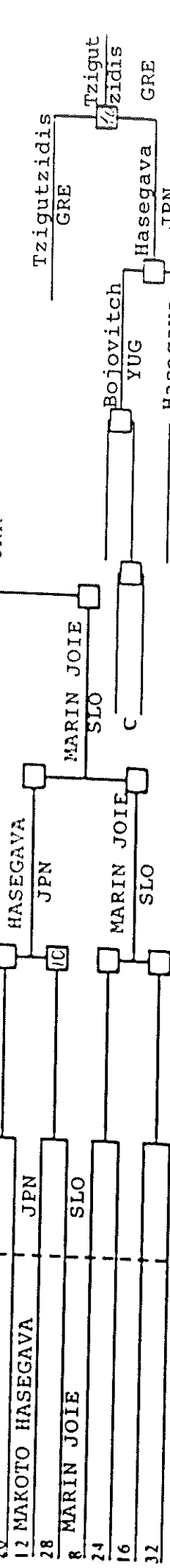

1. SELEJEN - UKR
2. LABUS - YUG
3. JOJE - SLO
3. TZIGUTZIDIS - GRE
5. RUSLAKOV - UKR
5. HASEGAVA - JPN

