



Event Report

Ulaanbaatar Grand Slam 2026, 19-21 Jun 2026

Event Report

454 competitors from 58 nations

253 Men

201 Women

55.73%

44.27%

-60 kg	-66 kg	-73 kg	-81 kg	-90 kg	-100 kg	+100 kg	Men
32	33	40	42	40	37	29	253

-48 kg	-52 kg	-57 kg	-63 kg	-70 kg	-78 kg	+78 kg	Women
29	29	29	28	33	28	25	201

Continent	EJU	JUA	PJC	OJU	AJU	Total
Nations	34	15	7	1	1	58
Competitors	244	184	15	5	6	454

Schedule	Day 1	Day 2	Day 3
Date	19 Jun	20 Jun	21 Jun
Start	09:30	09:30	09:30
End	14:55	14:51	14:53
Finals start	17:00	17:00	17:00
Finals end	19:50	19:51	19:46



Ulaanbaatar Grand Slam 2026

Mongolia, Ulaanbaatar, 19-21 Jun 2026

Seniors Men

Final results

-60 kg		
1	AGHAYEV Balabay	AZE
2	NAGAYAMA Ryuju	JPN
3	BYAMBASUREN Sukhbat	MGL
3	ASHPIZ Izhak	ISR
5	SARDALASHVILI Giorgi	GEO
5	YUSIFOV Ahmad	AZE
7	YANG Yung Wei	TPE
7	TUVSHINTUR Tumenjargal	MGL

-66 kg		
1	TAKEOKA Takeshi	JPN
2	ABDULAEV Ramazan	RUS
3	IMRANOV Nizami	AZE
3	KIM Channyeong	KOR
5	KAZIRBYEK Yolq	MGL
5	GARCIA TORNE David	ESP
7	PASHAYEV Ruslan	AZE
7	BATTOGTOKH Erkhembayar	MGL

-73 kg		
1	LAVJARGAL Ankhzaya	MGL
2	YONEZUKA Jack	USA
3	SKERLEV Victor	BUL
3	ODGEREL Uranbayar	MGL
5	GOGINASHVILI Irakli	GBR
5	ALOEV Mukhamed	BRN
7	DOUKKALI Hassan	MAR
7	HRISTOV Mark	BUL

-81 kg		
1	LEE Joonhwan	KOR
2	OINO Yuhei	JPN
3	ARBUZOV Timur	RUS
3	SIMIN Mihajlo	SRB
5	GAUTHIER DRAPEAU Francois	CAN
5	CASSE Matthias	BEL
7	KAIRROLLA Zhalgas	KAZ
7	IHANAMAKI Eetu	FIN

-90 kg		
1	MURAO Sanshiro	JPN
2	KIM Jonghoon	KOR
3	RUTOVIC Boris	SRB
3	FATIYEV Murad	AZE
5	NGAYAP HAMBOU Maxime-Gael	FRA
5	KOPECKY Adam	CZE
7	TSELIDIS Theodoros	GRE
7	MAJDOV Nemanja	SRB

-100 kg		
1	PIRELLI Gennaro	ITA
2	BIFOV Idar	RUS
3	SULAMANIDZE Ilia	GEO
3	KOTSOIEV Zelym	AZE
5	KOSTOEV Dzhafar	UAE
5	ADAMIAN Arman	RUS
7	BAIKAMUROV Marat	KAZ
7	MASUCHI Ryotaro	JPN

+100 kg		
1	KIM Minjong	KOR
2	DEMETRASHVILI Irakli	GEO
3	SPIJKERS Jur	NED
3	TASOEV Inal	RUS
5	NASIBOV Kanan	AZE
5	KRPALEK Lukas	CZE
7	ENDOVITSKII Valerii	RUS
7	NAKANO Kanta	JPN



Ulaanbaatar Grand Slam 2026

Mongolia, Ulaanbaatar, 19-21 Jun 2026

Seniors Women

Final results

-48 kg		
1	KOGA Wakana	JPN
2	ZHUANG Wenna	CHN
3	BEDER Tugce	TUR
3	MARTINEZ ABELENDIA Laura	ESP
5	ERSIN Sila	TUR
5	PETIT Lois	BEL
7	BOUKLI Shirine	FRA
7	BURKEYEVA Diana	KAZ

-52 kg		
1	ABE Uta	JPN
2	GIUFFRIDA Odette	ITA
3	PUPP Reka	HUN
3	BISHRELT Khorloodoi	UAE
5	GYERTYAS Roza	HUN
5	TORO SOLER Ariane	ESP
7	BALLHAUS Mascha	GER
7	VAN KREVEL Naomi	NED

-57 kg		
1	OMORI Akari	JPN
2	CYSIQUE Sarah Leonie	FRA
3	BALLHAUS Seija	GER
3	PARDAYEVA Maysa	TKM
5	NELSON LEVY Timna	ISR
5	MOKDAR Faiza	FRA
7	VAN DE MEEBERG Shannon	NED
7	TERBISH Ariunzaya	MGL

-63 kg		
1	KAJU Haruka	JPN
2	VAN LIESHOUT Joanne	NED
3	LILUASHVILI Dali	RUS
3	PIOVESANA Lubjana	AUT
5	LKHAGVATOGOO Enkhriilen	MGL
5	BAUER Sara-Joy	GER
7	GALITSKAIA Kseniia	RUS
7	AVANZATO Carlotta	ITA

-70 kg		
1	TANAKA Shiho	JPN
2	COUGHLAN Aoife	AUS
3	VAN DIJKE Sanne	NED
3	CVJETKO Lara	CRO
5	DE VOOGD Margit	NED
5	BUTKEREIT Miriam	GER
7	GOSHEN Maya	ISR
7	EME Clemence	FRA

-78 kg		
1	LYTVYNENKO Yelyzaveta	UAE
2	TCHEUMEO Audrey	FRA
3	BOEHM Alina	GER
3	OLAYA Brenda	COL
5	OLEK Anna Monta	GER
5	VAN HEEMST Yael	NED
7	LOBNIK Metka	SLO
7	PAVIC Petrunjela	CRO

+78 kg		
1	ARAI Mao	JPN
2	DICKO Romane	FRA
3	TAVANO Asya	ITA
3	CANCAN Celia	FRA
5	VUKOVIC Helena	CRO
5	AKTAS Emma-Melis	EST
7	HERSHKO Raz	ISR
7	MISHINER Yuli Alma	ISR



Nations Overview

Ulaanbaatar Grand Slam 2026, 19-21 Jun 2026

Nations

Overview

			-60	-66	-73	-81	-90	-100	+10	M	-48	-52	-57	-63	-70	-78	+78	W	Total	Ref	D	
1		AUS	Australia	1					1	2		1			1	1		3	5	0	2	
2		AUT	Austria				1	1	1	3				1	1	1		3	6	0	3	
3		AZE	Azerbaijan	2	2	2	1	2	1	2	12	1	1		1	1		1	5	17	0	14
4		BEL	Belgium			1	1			2	1						1	2	4	0	3	
5		BLR	Belarus				1	1		2				1		1		2	4	0	2	
6		BRN	Bahrain	1		1	1	1		4								0	4	0	1	
7		BUL	Bulgaria		1	2	2		1	6		1		1				2	8	0	2	
8		CAN	Canada		1	1	1		1	4		1				1		2	6	0	2	
9		CHI	Chile							0	1							1	1	0	1	
10		CHN	People's Republic of China	1	1	1		1	1	1	6	1		2			1	2	6	12	0	6
11		COL	Colombia							0						1		1	1	0	1	
12		CRO	Croatia						1	1	2			2	1	1	2	6	8	0	3	
13		CYP	Cyprus		1				1	1	3		1			1		2	5	0	1	
14		CZE	Czechia			1		1		1	3			1				1	4	0	4	
15		DEN	Denmark			1				1	1							0	1	0	1	
16		ESP	Spain		1				1	2	1	1			1			3	5	0	4	
17		EST	Estonia					1	1	2							1	1	3	0	2	
18		FIN	Finland		1	1	1			1	4			2		1		3	7	0	2	
19		FRA	France	1	1	1	1	2	1	1	8	1	1	2	1	1	2	2	10	18	0	12
20		GBR	Great Britain			1				1	1		1					1	2	0	1	
21		GEO	Georgia	1	2	2	1	1	1	1	9	1			2		1	4	13	0	7	
22		GER	Germany							0		1	1	2	2	2	1	9	9	0	3	
23		GRE	Greece				2	1		3								0	3	0	1	
24		HUN	Hungary						1	1		2						2	3	0	3	
25		IND	India		1		1			2								0	2	0	0	
26		IRL	Ireland			1		1		2								0	2	0	1	
27		ISR	Israel	1		1	1	2	1	6	1	1	2	1	2		2	9	15	0	6	
28		ITA	Italy	2	2	2	2	2	2	12	2	1	1	2	2		1	9	21	0	9	
29		JPN	Japan	1	1	1	1	1	1	1	7	1	1	1	1	1	1	7	14	0	31	
30		KAZ	Kazakhstan	2	2	2	2	2	1	11	2	1	2	2			2	9	20	0	7	
31		KGZ	Kyrgyzstan		1	1	2	1		5								0	5	0	1	
32		KOR	Republic of Korea	2	2	1	2	2	2	2	13	2	2	2	2	2		10	23	0	8	
33		LTU	Lithuania							0						1		1	1	0	1	
34		MAR	Morocco	1	1	1			1	4		1		1				2	6	0	2	
35		MAS	Malaysia				1			1								0	1	0	1	
36		MGL	Mongolia	4	4	4	4	4	4	4	28	4	4	4	4	4	4	28	56	0	16	
37		NED	Netherlands	1				2	1	1	5	1	1	1	1	2	2	8	13	0	4	
38		PHI	Philippines	1	1					2								0	2	0	0	
39		POL	Poland				1	1	2	1	5		1		1			2	7	0	4	
40		POR	Portugal		1					1	1							1	2	0	1	
41		PUR	Puerto Rico				1			1								0	1	0	1	
42		ROU	Romania			1	1	1	2	1	6					1		1	7	0	4	
43		RUS	Russian Federation	2	2	2	1	2	2	2	13	2	1	2	2	1	1	2	11	24	0	24
44		SLO	Slovenia	1						1					2	1		3	4	0	2	
45		SRB	Serbia				2	2	2	6						1		1	7	0	4	



Nations Overview

Ulaanbaatar Grand Slam 2026, 19-21 Jun 2026

Nations

Overview

			-60	-66	-73	-81	-90	-100	+10	M	-48	-52	-57	-63	-70	-78	+78	W	Total	Ref	D
46		SUI	Switzerland				1		1		2							0	2	0	1
47		SVK	Slovakia					1	1	1	3				1			1	4	0	2
48		SWE	Sweden						1		1				2			2	3	0	1
49		TKM	Turkmenistan		2	1	2	2	1	2	10	1	1	2		2		6	16	0	10
50		TPE	Chinese Taipei		1	1			1		4	1	1	1	1	1	2	8	12	0	16
51		TUR	Türkiye				1			1	2	2		2		1	1	6	8	0	4
52		UAE	United Arab Emirates		1	1	2	2	1	1	9		1				1	2	11	0	4
53		UKR	Ukraine		2			1		1	4							0	4	0	2
54		URU	Uruguay								0			1				1	1	0	0
55		USA	United States of America				2	1	1		4							0	4	0	0
56		UZB	Uzbekistan		1	1					2							0	2	0	1
57		VEN	Venezuela				1				1							0	1	0	0
58		VIE	Vietnam								0	2	2					4	4	0	2
			32	33	40	42	40	37	29	253	29	29	29	28	33	28	25	201	454	0	251

Total: 454 competitors from 58 countries and 0 continents



Medals

Ulaanbaatar Grand Slam 2026, 19-21 Jun 2026

Medals

Nations: 24

#	Nation		1. Place	2. Place	3. Place	5. Place	7. Place
1.		JPN Japan	8	2			2
2.		KOR Republic of Korea	2	1	1		
3.		ITA Italy	1	1	1		1
4.		AZE Azerbaijan	1		3	2	1
5.		MGL Mongolia	1		2	2	3
6.		UAE United Arab Emirates	1		1	1	
7.		FRA France		3	1	2	2
8.		RUS Russian Federation		2	3	1	2
9.		NED Netherlands		1	2	2	2
10.		GEO Georgia		1	1	1	
11.		AUS Australia		1			
11.		CHN People's Republic of China		1			
11.		USA United States of America		1			
14.		GER Germany			2	3	1
15.		SRB Serbia			2		1
16.		ESP Spain			1	2	
17.		ISR Israel			1	1	3
18.		CRO Croatia			1	1	1
19.		HUN Hungary			1	1	
19.		TUR Türkiye			1	1	
21.		BUL Bulgaria			1		1
22.		AUT Austria			1		
22.		COL Colombia			1		
22.		TKM Turkmenistan			1		
25.		BEL Belgium				2	
25.		CZE Czechia				2	
27.		BRN Bahrain				1	
27.		CAN Canada				1	
27.		EST Estonia				1	
27.		GBR Great Britain				1	
31.		KAZ Kazakhstan					3
32.		TPE Chinese Taipei					1
32.		FIN Finland					1
32.		GRE Greece					1
32.		MAR Morocco					1
32.		SLO Slovenia					1

Official person:



Ulaanbaatar Grand Slam 2026

Mongolia, Ulaanbaatar, 19-21 Jun 2026

-60 kg

Seniors (32)

POOL A

	AGHAYEV Balabay	AZE
	LESIUK Artem	UKR
	KATZ Joshua	AUS
	RAMAZANOV Mekan	TKM
	SARDALASHVILI Giorgi	GEO
	STARKEL David	SLO
	ENKHTAIVAN Ariunbold	MGL
	BAKYTZHAN Aman	KAZ

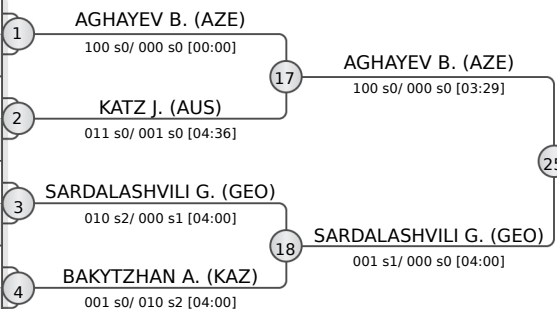

POOL B

	ASHPIZ Izhak	ISR
	JARING Emiel	NED
	NAKANO Shugen	PHI
	HWANG Hyesung	KOR
	YANG Yung Wei	TPE
	NYAMSUREN Mendsaikhan	MGL
	KOTELNIKOV Dmitrii	RUS
	CARLINO Andrea	ITA

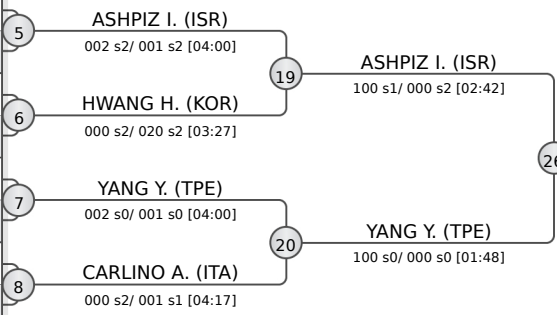

POOL C

	YUSIFOV Ahmad	AZE
	SIMEONIDIS Konstantin	UAE
	SHAMSHADIN Magzhan	KAZ
	D ANGELO Biagio	ITA
	BYAMBASUREN Sukhbat	MGL
	SUN Jiahao	CHN
	LEE Harim	KOR
	RUZIEV Doston	UZB

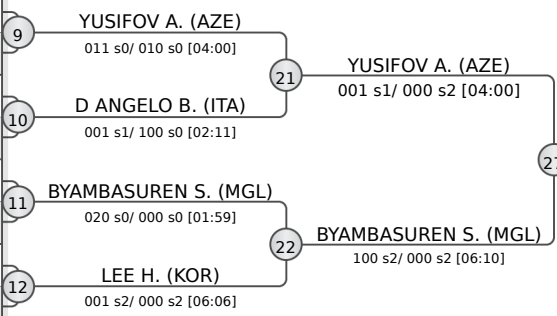

POOL D

	MKHEIDZE Luka	FRA
	POLTORATSKII Ruslan	BRN
	ALAOUI CHERIFI Ahmed	MAR
	TUVSHINTUR Tumenjargal	MGL
	NAGAYAMA Ryuju	JPN
	KHALMATOV Dilshot	UKR
	DOMBUU Achyty	RUS
	BAHTIYAROV Ural	TKM

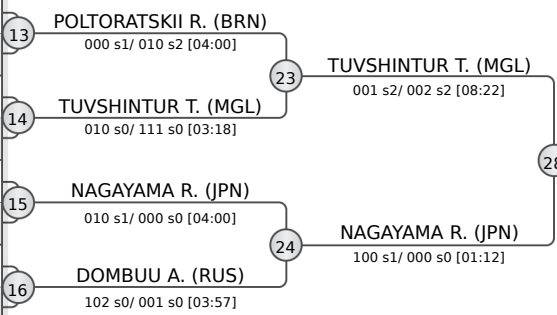

REPECHAGE

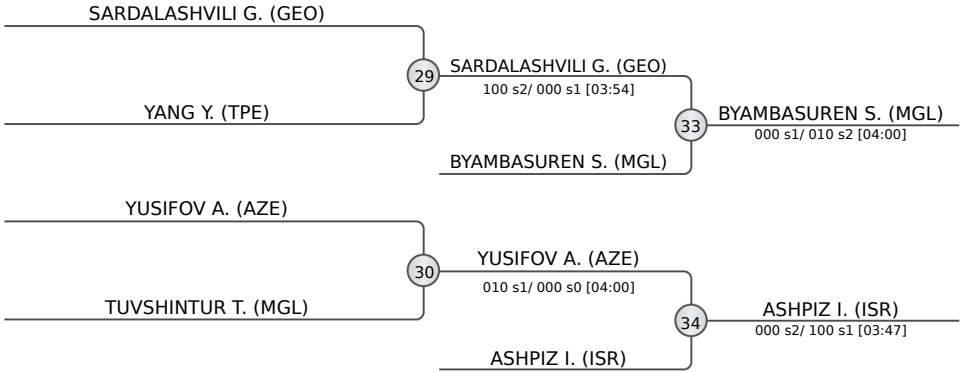

FINAL RESULTS	
1.	AGHAYEV Balabay AZE
2.	NAGAYAMA Ryuju JPN
3.	BYAMBASUREN Sukhbat MGL
3.	ASHPIZ Izhak ISR
5.	SARDALASHVILI Giorgi GEO
5.	YUSIFOV Ahmad AZE
7.	YANG Yung Wei TPE
7.	TUVSHINTUR Tumenjargal MGL





Ulaanbaatar Grand Slam 2026

Mongolia, Ulaanbaatar, 19-21 Jun 2026

-73 kg

Seniors (40)

POOL A

	MAKHMADBEKOV Makhmadbek	UAE
	LOMBARDO Manuel	ITA
	AN Jaehong	KOR
	TERASHVILI Giorgi	GEO
	SKERLEV Victor	BUL
	ODGEREL Uranbayar	MGL
	KARIMOV Chusniddin	CZE
	PARICHE Andres	VEN
	GALSTIAN Karen	RUS
	OLIN Valteri	FIN

1	MAKHMADBEKOV M. (UAE)	
2	LOMBARDO M. (ITA)	33
3	AN J. (KOR)	
4	SKERLEV V. (BUL)	34
5	ODGEREL U. (MGL)	
6	KARIMOV C. (CZE)	35
7	GALSTIAN K. (RUS)	
8	OLIN V. (FIN)	36

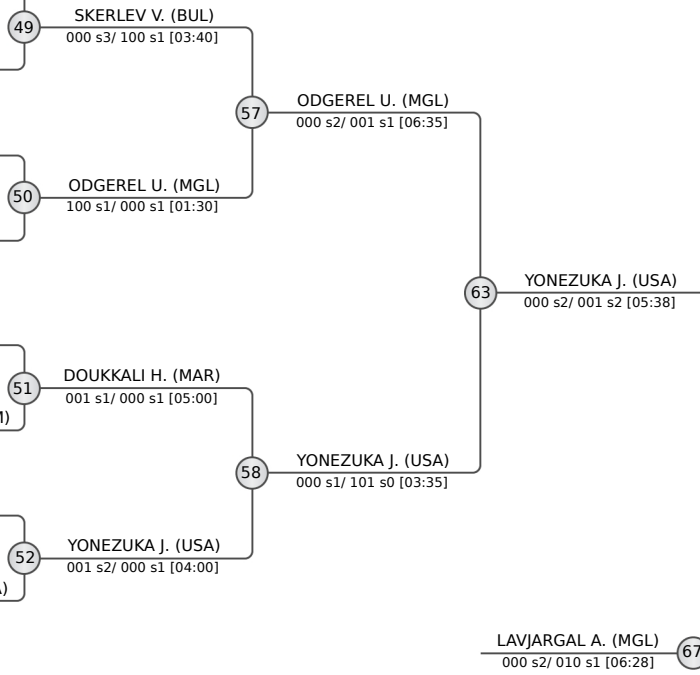

POOL B

	MAMMADALIYEV Rashid	AZE
	DOUKKALI Hassan	MAR
	LKHAMAA Enkhdul	MGL
	ZHANG Minghao	CHN
	SHAMURADOV Meylis	TKM
	YONEZUKA Jack	USA
	GREEN Joshua	IRL
	DZITAC Ioan	ROU
	BOULEMTAFES Dayyan	FRA
	GAINULLIN Angsarbek	KAZ

9	MAMMADALIYEV R. (AZE)	
10	DOUKKALI H. (MAR)	37
11	ZHANG M. (CHN)	
12	SHAMURADOV M. (TKM)	38
13	YONEZUKA J. (USA)	
14	GREEN J. (IRL)	39
15	BOULEMTAFES D. (FRA)	
16	GAINULLIN A. (KAZ)	40

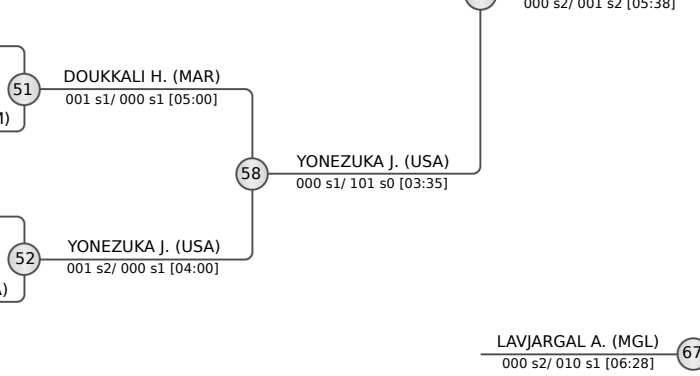

POOL C

	HEYDAROV Hidayat	AZE
	ALTAIBAATAR Usukhjargal	MGL
	ESPOSITO Giovanni	ITA
	BAKIRDINOV Nurmukhammed	KGZ
	HRISTOV Mark	BUL
	SHAVDATUASHVILI Lasha	GEO
	LEMIRE Justin	CAN
	ELBAZ Yehonatan	ISR
	GOGINASHVILI Irakli	GBR
	BOLDBAATAR Steven	USA

17	HEYDAROV H. (AZE)	
18	ALTAIBAATAR U. (MGL)	41
19	ESPOSITO G. (ITA)	
20	HRISTOV M. (BUL)	42
21	SHAVDATUASHVILI L. (GEO)	
22	LEMIRE J. (CAN)	43
23	GOGINASHVILI I. (GBR)	
24	BOLDBAATAR S. (USA)	44

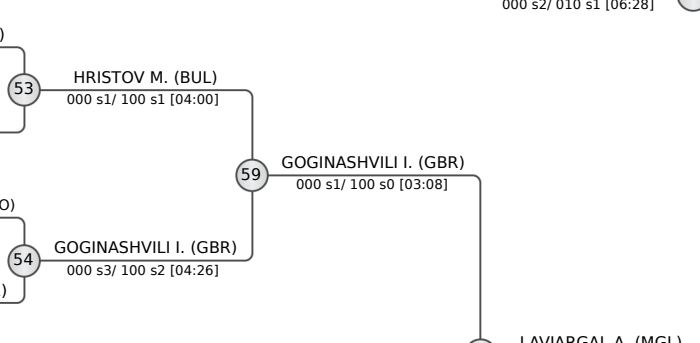

POOL D

	LAVRENTEV Danil	RUS
	AMANSAHEDOV Ulaman	TKM
	TANAKA Ryuga	JPN
	ALOE V Mukhamed	BRN
	ERRBOE Morgan	DEN
	LAVJARGAL Ankhzaya	MGL
	NAGUCHEV Kazbek	UAE
	CILOGLU Bilal	TUR
	KUANOV Yesset	KAZ
	UMAYEV Abdul Malik	BEL

25	LAVRENTEV D. (RUS)	
26	TANAKA R. (JPN)	45
27	ALOE V M. (BRN)	
28	ERRBOE M. (DEN)	46
29	LAVJARGAL A. (MGL)	
30	NAGUCHEV K. (UAE)	47
31	KUANOV Y. (KAZ)	
32	UMAYEV A. (BEL)	48

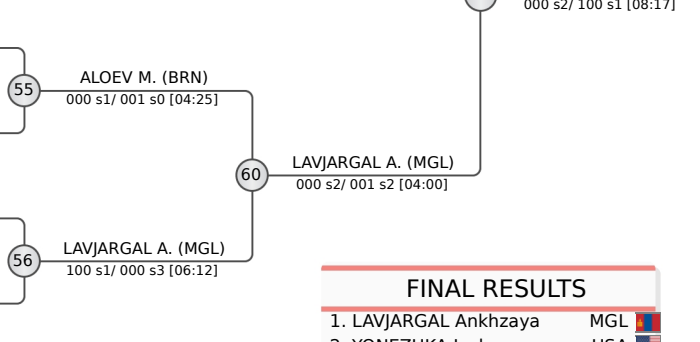

REPECHAGE

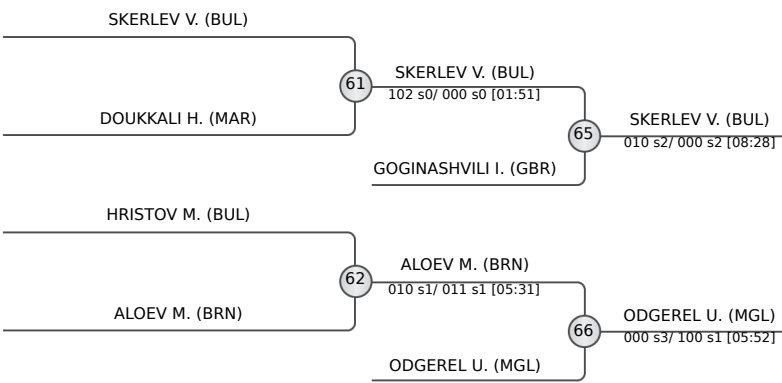

FINAL RESULTS	
1.	LAVJARGAL Ankhzaya MGL
2.	YONEZUKA Jack USA
3.	SKERLEV Victor BUL
3.	ODGEREL Uranbayar MGL
5.	GOGINASHVILI Irakli GBR
5.	ALOE V Mukhamed BRN
7.	DOUKKALI Hassan MAR
7.	HRISTOV Mark BUL





Ulaanbaatar Grand Slam 2026

Mongolia, Ulaanbaatar, 19-21 Jun 2026

-81 kg

Seniors (42)

POOL A

1	ARBUZOV Timur	RUS
2	ALMAZJAN UULU Tegin	KGZ
3	MERDANOV Batyr	TKM
4	BONFERRONI Aurelien	SUI
5	GRUJICIC Vasilije	SRB
6	CASAGLIA Leonardo	ITA
7	FASCHING Bernd	AUT
8	BADRAXH Shinetulga	MGL
9	LEE Joonhwan	KOR
10	SILOT Johan	USA
11	BIBITKO Itay	ISR

1	ARBUZOV T. (RUS)	33	ARBUZOV T. (RUS)
2	ALMAZJAN UULU T. (KGZ)	100 s0/ 000 s1 [02:57]	011 s0/ 000 s1 [04:00]
3	GRUJICIC V. (SRB)	000 s0/ 101 s2 [03:13]	000 s1/ 001 s0 [04:00]
4	CASAGLIA L. (ITA)	000 s1/ 001 s0 [04:00]	
5	FASCHING B. (AUT)		
6	LEE J. (KOR)	000 s0/ 100 s0 [02:27]	000 s0/ 100 s0 [02:27]
7	SILOT J. (USA)		
8	BIBITKO I. (ISR)	100 s0/ 000 s1 [02:05]	

49	ARBUZOV T. (RUS)	100 s0/ 000 s1 [00:40]
50	LEE J. (KOR)	101 s0/ 000 s0 [01:35]
51	KAIROLLA Z. (KAZ)	000 s0/ 100 s1 [05:08]
52	CASSE M. (BEL)	000 s3/ 100 s1 [02:57]
53	OINO Y. (JPN)	010 s0/ 000 s1 [04:00]
54	SIMIN M. (SRB)	100 s1/ 000 s2 [02:45]
55	GAUTHIER DRAPEAU F. (CAN)	001 s0/ 000 s1 [04:00]
56	IHANAMAKI E. (FIN)	101 s2/ 000 s1 [05:21]

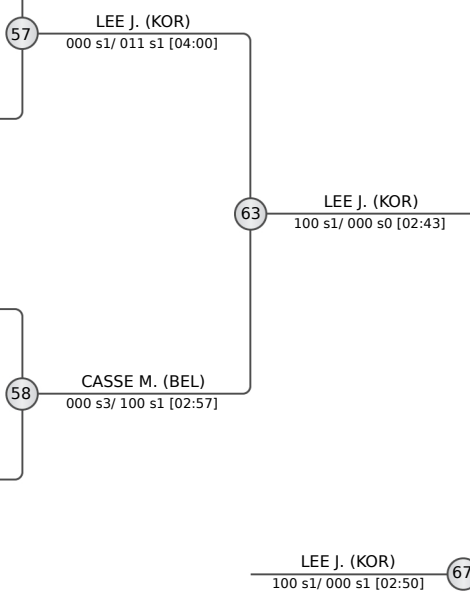

POOL B

9	TCKAEV Zelim	AZE
10	OMAROV Gadzhimurad	UAE
11	TOKAS Harsh	IND
12	KAIROLLA Zhalgas	KAZ
13	TARKOWSKI Fabrycjusz	POL
14	CASSE Matthias	BEL
15	GRAMATIKOV Georgi	BUL
16	SULCA Adrian	ROU
17	JUGDERGARAV Enkhtur	MGL
18	ZARAGKAS Aris	GRE

9	TCKAEV Z. (AZE)	37	OMAROV G. (UAE)
10	OMAROV G. (UAE)	101 s1/ 000 s3 [03:26]	000 s2/ 100 s2 [05:54]
11	KAIROLLA Z. (KAZ)	000 s0/ 100 s1 [05:08]	000 s0/ 100 s1 [05:08]
12	TARKOWSKI F. (POL)	100 s0/ 000 s0 [01:11]	
13	CASSE M. (BEL)		
14	GRAMATIKOV G. (BUL)	100 s0/ 000 s3 [04:20]	100 s0/ 000 s3 [04:20]
15	SULCA A. (ROU)	010 s1/ 000 s2 [04:30]	010 s1/ 000 s2 [04:30]
16	ZARAGKAS A. (GRE)	100 s1/ 000 s3 [02:46]	

57	LEE J. (KOR)	000 s1/ 011 s1 [04:00]
58	CASSE M. (BEL)	000 s3/ 100 s1 [02:57]
59	OINO Y. (JPN)	010 s0/ 000 s1 [04:00]
60	GAUTHIER DRAPEAU F. (CAN)	001 s0/ 000 s1 [04:00]
61	ARBUZOV T. (RUS)	101 s0/ 000 s0 [01:00]
62	SIMIN M. (SRB)	010 s1/ 000 s0 [04:00]
63	LEE J. (KOR)	100 s1/ 000 s0 [02:43]
64	OINO Y. (JPN)	100 s0/ 000 s0 [00:15]
65	ARBUZOV T. (RUS)	002 s0/ 000 s2 [04:00]
66	SIMIN M. (SRB)	001 s1/ 000 s1 [06:07]
67	LEE J. (KOR)	100 s1/ 000 s1 [02:50]

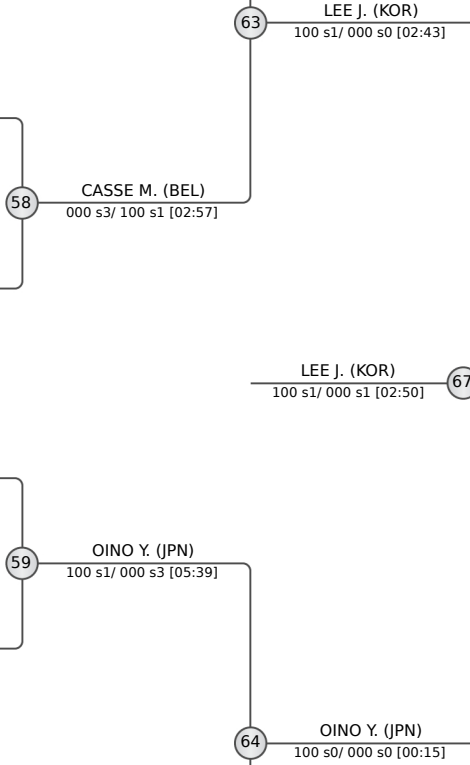

POOL C

17	OINO Yuhei	JPN
18	GERBEKOV Askerbii	BRN
19	DVALASHVILI Zaur	GEO
20	TATALASHVILI Nugzari	UAE
21	GANDIA Adrian	PUR
22	SIMIN Mihajlo	SRB
23	GANZORIG Tuvdenrenchin	MGL
24	BIN ABDUL MAJEED Amir Daniel	MAS
25	SAGYNALIEV Chyngyzkhan	KGZ
26	NARKULOV Askar	KAZ

17	OINO Y. (JPN)	41	OINO Y. (JPN)
18	DVALASHVILI Z. (GEO)	001 s2/ 100 s1 [03:32]	010 s1/ 000 s0 [04:00]
19	TATALASHVILI N. (UAE)	000 s0/ 100 s0 [03:18]	001 s1/ 100 s0 [03:18]
20	GANDIA A. (PUR)	001 s1/ 100 s0 [03:18]	
21	SIMIN M. (SRB)		
22	GANZORIG T. (MGL)	110 s0/ 000 s0 [01:05]	110 s0/ 000 s0 [01:05]
23	BIN ABDUL MAJEED A. (MAS)	100 s0/ 000 s0 [00:00]	100 s1/ 010 s0 [02:25]
24	NARKULOV A. (KAZ)	100 s1/ 010 s0 [02:25]	

53	OINO Y. (JPN)	010 s0/ 000 s1 [04:00]
54	SIMIN M. (SRB)	100 s1/ 000 s2 [02:45]
55	GAUTHIER DRAPEAU F. (CAN)	001 s0/ 000 s1 [04:00]
56	IHANAMAKI E. (FIN)	101 s2/ 000 s1 [05:21]

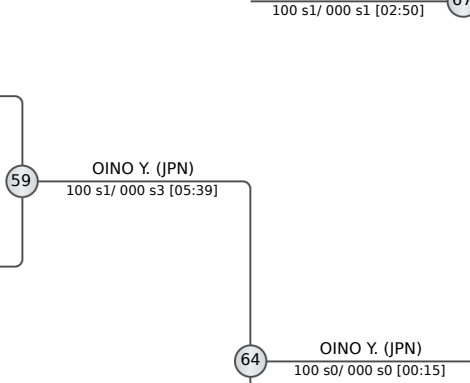

POOL D

25	GAUTHIER DRAPEAU Francois	CAN
26	OYUNCHIMEG Shinebayar	MGL
27	AREGBA Arnaud	FRA
28	CHARNIAK Maksim	BLR
29	SIM Jaeyun	KOR
30	IHANAMAKI Eetu	FIN
31	VALKOV Hristo	BUL
32	TSOUTLASVILI Michail	GRE
33	AYHANOV Agajan	TKM
34	SVIDRAK Mykhailo	UKR
35	ESPOSITO Antonio	ITA

25	GAUTHIER DRAPEAU F. (CAN)	45	GAUTHIER DRAPEAU F. (CAN)
26	OYUNCHIMEG S. (MGL)	100 s2/ 000 s2 [04:28]	010 s2/ 000 s1 [05:47]
27	CHARNIAK M. (BLR)		
28	SIM J. (KOR)	000 s1/ 101 s0 [03:25]	000 s1/ 101 s0 [03:25]
29	IHANAMAKI E. (FIN)		
30	VALKOV H. (BUL)	100 s0/ 000 s0 [03:55]	100 s1/ 000 s1 [05:05]
31	AYHANOV A. (TKM)	010 s0/ 002 s0 [04:00]	010 s0/ 002 s0 [04:00]
32	ESPOSITO A. (ITA)	000 s0/ 001 s0 [04:00]	000 s0/ 001 s0 [04:00]

57	LEE J. (KOR)	000 s1/ 011 s1 [04:00]
58	CASSE M. (BEL)	000 s3/ 100 s1 [02:57]
59	OINO Y. (JPN)	010 s0/ 000 s1 [04:00]
60	GAUTHIER DRAPEAU F. (CAN)	001 s0/ 000 s1 [04:00]
61	ARBUZOV T. (RUS)	101 s0/ 000 s0 [01:00]
62	SIMIN M. (SRB)	010 s1/ 000 s0 [04:00]
63	LEE J. (KOR)	100 s1/ 000 s0 [02:43]
64	OINO Y. (JPN)	100 s0/ 000 s0 [00:15]
65	ARBUZOV T. (RUS)	002 s0/ 000 s2 [04:00]
66	SIMIN M. (SRB)	001 s1/ 000 s1 [06:07]
67	LEE J. (KOR)	100 s1/ 000 s1 [02:50]

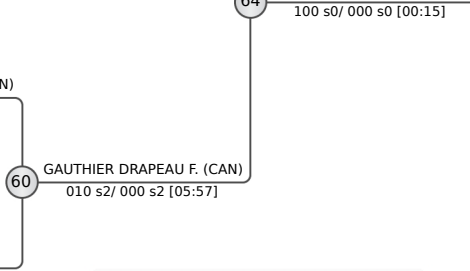

REPECHAGE

61	ARBUZOV T. (RUS)	101 s0/ 000 s0 [01:00]
62	SIMIN M. (SRB)	010 s1/ 000 s0 [04:00]
63	LEE J. (KOR)	100 s1/ 000 s0 [02:43]
64	OINO Y. (JPN)	100 s0/ 000 s0 [00:15]
65	ARBUZOV T. (RUS)	002 s0/ 000 s2 [04:00]
66	SIMIN M. (SRB)	001 s1/ 000 s1 [06:07]
67	LEE J. (KOR)	100 s1/ 000 s1 [02:50]

61	ARBUZOV T. (RUS)	101 s0/ 000 s0 [01:00]
62	SIMIN M. (SRB)	010 s1/ 000 s0 [04:00]
63	LEE J. (KOR)	100 s1/ 000 s0 [02:43]
64	OINO Y. (JPN)	100 s0/ 000 s0 [00:15]
65	ARBUZOV T. (RUS)	002 s0/ 000 s2 [04:00]
66	SIMIN M. (SRB)	001 s1/ 000 s1 [06:07]
67	LEE J. (KOR)	100 s1/ 000 s1 [02:50]

FINAL RESULTS		
1.	LEE Joonhwan	KOR
2.	OINO Yuhei	JPN
3.	ARBUZOV Timur	RUS
3.	SIMIN Mihajlo	SRB
5.	GAUTHIER DRAPEAU Francois	CAN
5.	CASSE Matthias	BEL
7.	KAIROLLA Zhalgas	KAZ
7.	IHANAMAKI Eetu	FIN





Ulaanbaatar Grand Slam 2026

Mongolia, Ulaanbaatar, 19-21 Jun 2026

-90 kg

Seniors (40)

POOL A

1	MURAO Sanshiro (JPN)	1	MURAO S. (JPN)
2	BEDEL Kenny Komi (ITA)	2	BEDEL K. (ITA)
3	SCHARFETTER Thomas (AUT)	3	SCHARFETTER T. (AUT)
4	ANKHBAYAR Odjavkhlan (MGL)	4	KANATBEKOV E. (KGZ)
5	RUTOVIC Boris (SRB)	5	RUTOVIC B. (SRB)
6	LORSANOV Mansur (RUS)	6	LORSANOV M. (RUS)
7	FRIDMAN ZILBERSTEIN Reem (ISR)	7	MATHIEU A. (FRA)
8	MATHIEU Alexis (FRA)	8	CHEN Peng-Yu (TPE)

POOL B

9	TSELIDIS Theodoros (GRE)	9	TSELIDIS T. (GRE)
10	CRET Alex (ROU)	10	CRET A. (ROU)
11	BISENOV Nurzhan (KAZ)	11	BARTO A. (SVK)
12	BARTO Alex (SVK)	12	KIM J. (KOR)
13	KOPECKY Adam (CZE)	13	KOPECKY A. (CZE)
14	KOTSOEV Aslan (AZE)	14	KOTSOEV A. (AZE)
15	BOLDBAATAR Bayanduuren (MGL)	15	VAN DIJK M. (NED)
16	VAN DIJK Markus (NED)	16	KALJULAI K. (EST)
	KALJULAI Klen Kristofer (EST)		

POOL C

17	KIM Jonghoon (KOR)	17	KIM J. (KOR)
18	VARAPAYEU Yahor (BLR)	18	VARAPAYEU Y. (BLR)
19	GLEESON Bearach (IRL)	19	DE WIT F. (NED)
20	DE WIT Frank (NED)	20	DAVAADORJ U. (MGL)
21	DAVAADORJ Uuganbileg (MGL)	21	MAJDOV N. (SRB)
22	MAJDOV Nemanja (SRB)	22	JAVAKHISHVILI L. (GEO)
23	JAVAKHISHVILI Luka (GEO)	23	PARLATI C. (ITA)
24	GRIGORIAN Aram (UAE)	24	NYSSANALI A. (KAZ)
	PARLATI Christian (ITA)		
	NYSSANALI Aibol (KAZ)		

POOL D

25	FATIYEV Murad (AZE)	25	FATIYEV M. (AZE)
26	SAGAIPOV Israpil (BRN)	26	SAGAIPOV I. (BRN)
27	HALMUMINOV Omuruzak (TKM)	27	JAYNE J. (USA)
28	JAYNE John (USA)	28	MARCZAK D. (POL)
29	MARCZAK Derek (POL)	29	NGAYAP HAMBOU M. (FRA)
30	NGAYAP HAMBOU Maxime-Gael (FRA)	30	SIVAN R. (ISR)
31	SIVAN Roy (ISR)	31	BU H. (CHN)
32	KHASBAATAR Bulgankhuu (MGL)	32	ANDONI E. (RUS)
	BU Hebilige (CHN)		
	ANDONI Egor (RUS)		

REPECHAGE

61	RUTOVIC B. (SRB)	61	RUTOVIC B. (SRB)
	TSELIDIS T. (GRE)		
	MAJDOV N. (SRB)		
	FATIYEV M. (AZE)		
	FATIYEV M. (AZE)		
	KOPECKY A. (CZE)		

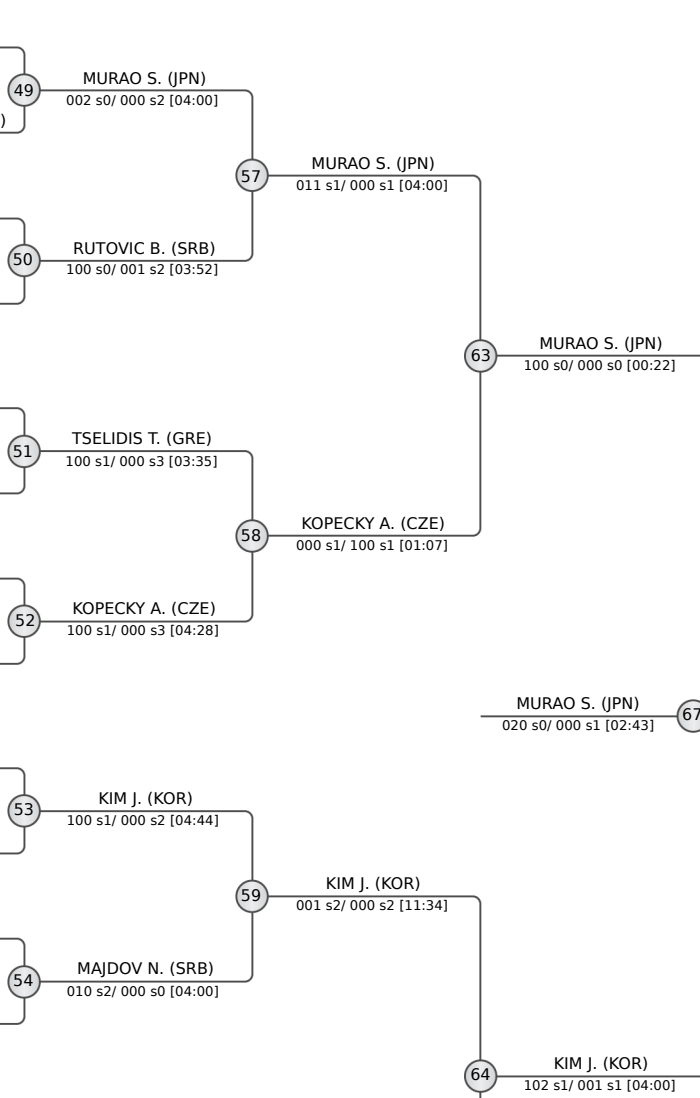

FINAL RESULTS		
1.	MURAO Sanshiro	JPN
2.	KIM Jonghoon	KOR
3.	RUTOVIC Boris	SRB
3.	FATIYEV Murad	AZE
5.	NGAYAP HAMBOU Maxime-Gael	FRA
5.	KOPECKY Adam	CZE
7.	TSELIDIS Theodoros	GRE
7.	MAJDOV Nemanja	SRB





Ulaanbaatar Grand Slam 2026

Mongolia, Ulaanbaatar, 19-21 Jun 2026

-100 kg

Seniors (37)

POOL A

1	SAVYTSKIY Anton (UKR)	1	SAVYTSKIY A. (UKR)
2	SIMIN Iosif (ISR)	2	SIMIN I. (ISR) 33
3	BAIKAMUROV Marat (KAZ)	3	BAIKAMUROV M. (KAZ) 100 s0/000 s0 [00:38]
4	OTGONSUREN Lkhagva-Ochir (MGL)	4	BAIKAMUROV M. (KAZ) 34 010 s1/000 s1 [04:00]
5	ARSENIE Rares (ROU)	5	ARSENIE R. (ROU)
6	VEG Zsombor (HUN)	6	VEG Z. (HUN)
7	JEDRZEJEWSKI Michal (POL)	7	HAN J. (KOR) 35 000 s3/100 s2 [05:12]
8	HAN Juyeop (KOR)	8	HAN J. (KOR) 36 000 s3/100 s0 [04:33]
9	VARES Jakob (EST)	9	VARES J. (EST)
10	PIRELLI Gennaro (ITA)	10	PIRELLI G. (ITA) 50 000 s3/100 s0 [03:54]

POOL B

9	SULAMANIDZE Ilia (GEO)	9	SULAMANIDZE I. (GEO)
10	SHERAZADISHVILI Nikoloz (ESP)	10	SHERAZADISHVILI N. (ESP) 37 010 s1/000 s1 [04:00]
11	MAJANOV Baymyrat (TKM)	11	MAJANOV B. (TKM)
12	BAATHE Karl (SWE)	12	BAATHE K. (SWE) 38 010 s0/000 s0 [04:00]
13	ADAMIAN Arman (RUS)	13	ADAMIAN A. (RUS)
14	TSERENBAT Gan-Erdene (MGL)	14	TSERENBAT G. (MGL) 39 021 s0/000 s1 [02:21]
15	EICH Daniel (SUI)	15	EICH D. (SUI)
16	HUANG Fuchun (CHN)	16	HUANG F. (CHN) 40 101 s0/000 s0 [03:34]
17	ZDRALE Lazar (SRB)	17	ZDRALE L. (SRB) 40 010 s1/000 s2 [04:00]

POOL C

17	KOTSOIEV Zelym (AZE)	17	KOTSOIEV Z. (AZE)
18	HAN Seungju (KOR)	18	HAN S. (KOR) 41 100 s1/000 s2 [01:34]
19	MATASEJE Benjamin (SVK)	19	MATASEJE B. (SVK)
20	SIBISAN Alexandru (ROU)	20	SIBISAN A. (ROU) 42 001 s1/000 s1 [04:00]
21	BIFOV Idar (RUS)	21	BIFOV I. (RUS)
22	KUCZERA Piotr (POL)	22	KUCZERA P. (POL) 43 100 s0/000 s0 [00:57]
23	GEORGIEV Boris (BUL)	23	GEORGIEV B. (BUL) 43 010 s1/001 s0 [04:00]
24	BATDORJ Altangerel (MGL)	24	BATDORJ A. (MGL) 44 000 s0/020 s0 [00:27]
25	KROUSSANIOTAKIS Georgios (CYP)	25	KROUSSANIOTAKIS G. (CYP) 44 000 s0/020 s0 [00:27]

POOL D

25	CATHARINA Simeon (NED)	25	CATHARINA S. (NED)
26	MASUCHI Ryotaro (JPN)	26	MASUCHI R. (JPN) 45 000 s3/100 s0 [03:59]
27	KARATAYEV Deniz (TKM)	27	KARATAYEV D. (TKM) 45 100 s0/000 s3 [01:59]
28	MEKHOUKH Fares (FRA)	28	MEKHOUKH F. (FRA)
29	CARLETTI Jean (ITA)	29	CARLETTI J. (ITA) 46 100 s1/000 s2 [06:24]
30	KOSTOEV Dzhafar (UAE)	30	KOSTOEV D. (UAE)
31	KUMRIC Zlatko (CRO)	31	KUMRIC Z. (CRO) 47 010 s1/000 s2 [04:51]
32	BAYARTSENGEL Khuderchuluun (MGL)	32	BAYARTSENGEL K. (MGL)
33	BRASNJOVIC Darko (SRB)	33	BRASNJOVIC D. (SRB) 48 010 s2/000 s1 [04:15]

REPECHAGE

61	SULAMANIDZE I. (GEO) 000 s2/001 s2 [04:00]	65	SULAMANIDZE I. (GEO) 100 s0/000 s0 [00:00]
62	KOTSOIEV Z. (AZE) 100 s0/000 s0 [00:17]	66	KOTSOIEV Z. (AZE) 100 s0/000 s0 [00:00]

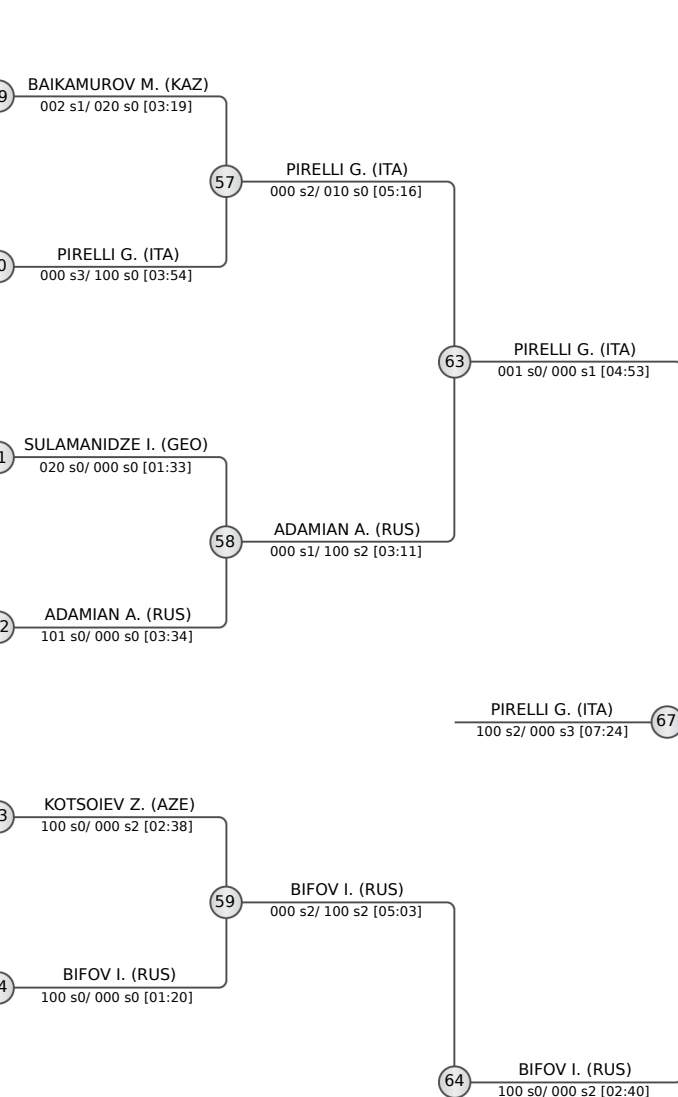

FINAL RESULTS	
1.	PIRELLI Gennaro (ITA)
2.	BIFOV Idar (RUS)
3.	SULAMANIDZE Ilia (GEO)
3.	KOTSOIEV Zelym (AZE)
5.	KOSTOEV Dzhafar (UAE)
7.	BAIKAMUROV Marat (KAZ)
7.	MASUCHI Ryotaro (JPN)





Ulaanbaatar Grand Slam 2026

Mongolia, Ulaanbaatar, 19-21 Jun 2026

+100 kg

Seniors (29)

POOL A

	TASOEV Inal	RUS
	AKIANA MONGO Matheo	FRA
	ANTONIOU Giannis	CYP
	ENDOVITSKII Valerii	RUS
	HEGYI Stephan	AUT
	GANTULGA Khangarid	MGL
	MESSE A BESSONG John	CAN

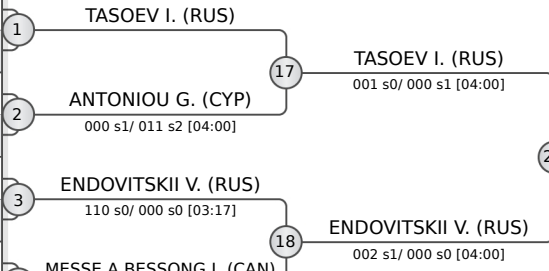

POOL B

	NASIBOV Kanan	AZE
	SORDYL Jakub	POL
	MAGOMEDOMAROV Magomedomar	UAE
	ERTUG Munir	TUR
	GAMZATKHANOV Dzhamal	AZE
	LI Haiyang	CHN
	USUKHBAYAR Perenleijamts	MGL
	KIM Minjong	KOR

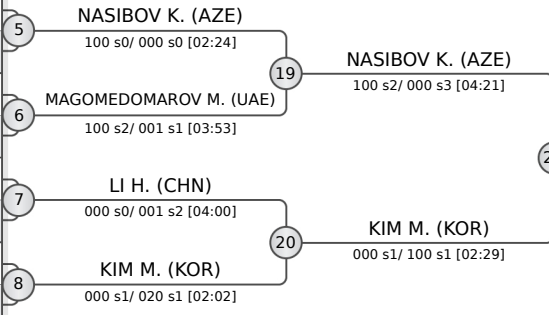

POOL C

	DEMETRASHVILI Irakli	GEO
	DOBRE Darius	ROU
	GANTULGA Altanbagana	MGL
	NAKANO Kanta	JPN
	SVIRYD Mikita	CRO
	FIZEL Marius	SVK
	LAHBOUB Mohammed	MAR

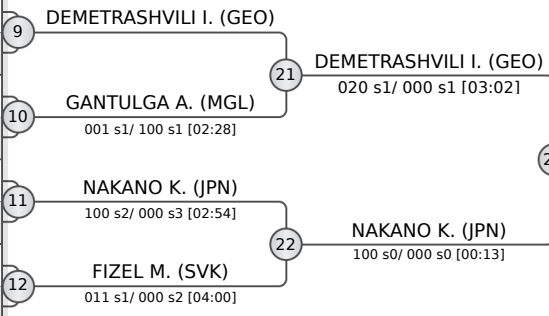

POOL D

	SPIJKERS Jur	NED
	PUUMALAINEN Martti	FIN
	ULZIIBAYAR Duurenbayar	MGL
	KRPALEK Lukas	CZE
	LEE Seungyeob	KOR
	DAI You-Ming	TPE
	OZCICEK-TAKAGI Kayhan	AUS

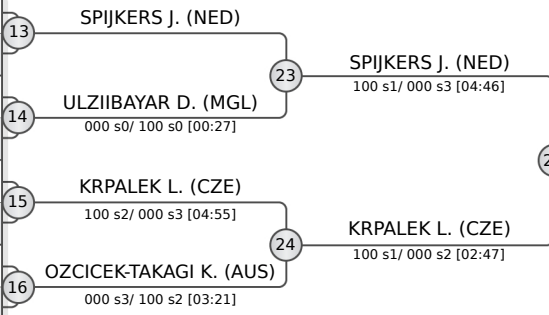

REPECHAGE

ENDOVITSKII V. (RUS)	29	NASIBOV K. (AZE)	000 s2/ 001 s1 [04:00]
NASIBOV K. (AZE)		SPIJKERS J. (NED)	000 s1/ 001 s2 [05:00]
NAKANO K. (JPN)	30	KRPALEK L. (CZE)	001 s0/ 101 s0 [01:44]
KRPALEK L. (CZE)		TASOEV I. (RUS)	001 s1/ 010 s1 [04:00]



FINAL RESULTS	
1. KIM Minjong	KOR
2. DEMETRASHVILI Irakli	GEO
3. SPIJKERS Jur	NED
3. TASOEV Inal	RUS
5. NASIBOV Kanan	AZE
5. KRPALEK Lukas	CZE
7. ENDOVITSKII Valerii	RUS
7. NAKANO Kanta	JPN





Ulaanbaatar Grand Slam 2026

Mongolia, Ulaanbaatar, 19-21 Jun 2026

-48 kg

Seniors (29)

POOL A

	BOUKLI Shirine	FRA
	TYNBAYEVA Galiya	KAZ
	MALCA Tamar	ISR
	GERSJES Amber	NED
	BAVUUDORJ Baasankhuu	MGL
	HA NGOC Chi	VIE
	PETIT Lois	BEL

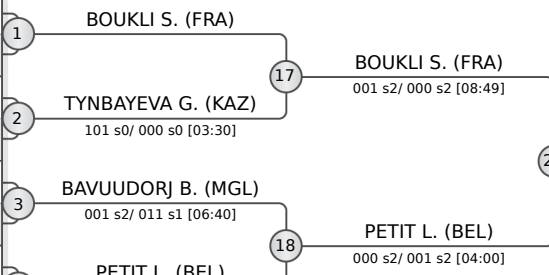

POOL B

	GILIAZOVA Sabina	RUS
	ERSIN Sila	TUR
	YU Juhee	KOR
	LKHAGVAJAV Bulgan	MGL
	VARGAS LEY Mary Dee	CHI
	ZHUANG Wenna	CHN
	MILANI Francesca	ITA
	RODONAIA Julieta	GEO

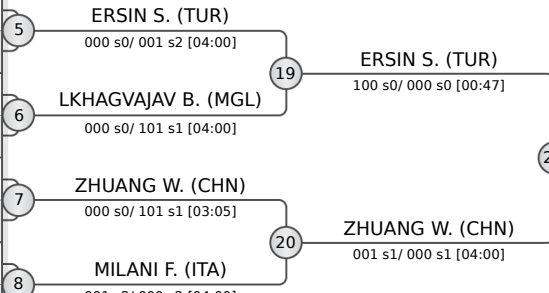

POOL C

	JAMSRAN Anudari	MGL
	AVANZATO Asia	ITA
	BEDER Tugce	TUR
	GANBAATAR Narantsetseg	MGL
	COSTA Catarina	POR
	GELDIYEVA Ejegyz	TKM
	BURKEYEVA Diana	KAZ

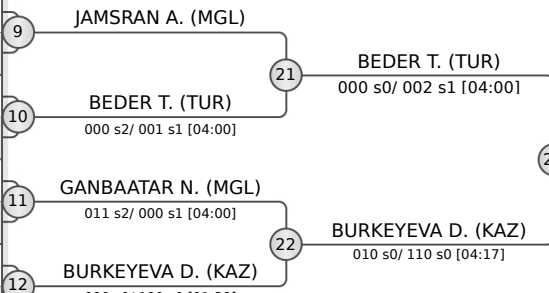

POOL D

	MARTINEZ ABELENDA Laura	ESP
	JUNG Su Jin	KOR
	TO Trang	VIE
	KOGA Wakana	JPN
	HAMIDOVA Shafag	AZE
	VOROBEVA Marina	RUS
	LIN Chen-Hao	TPE

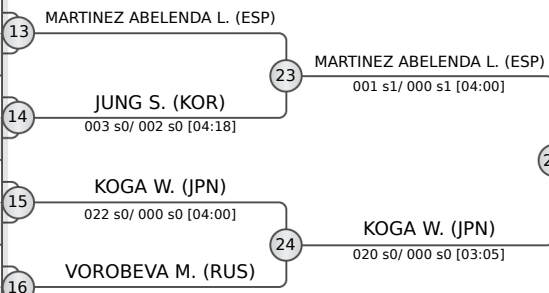

REPECHAGE

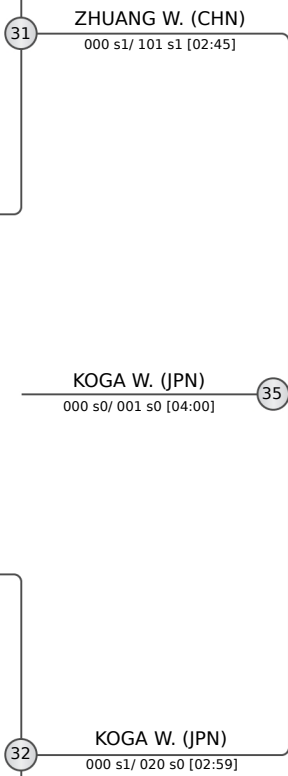
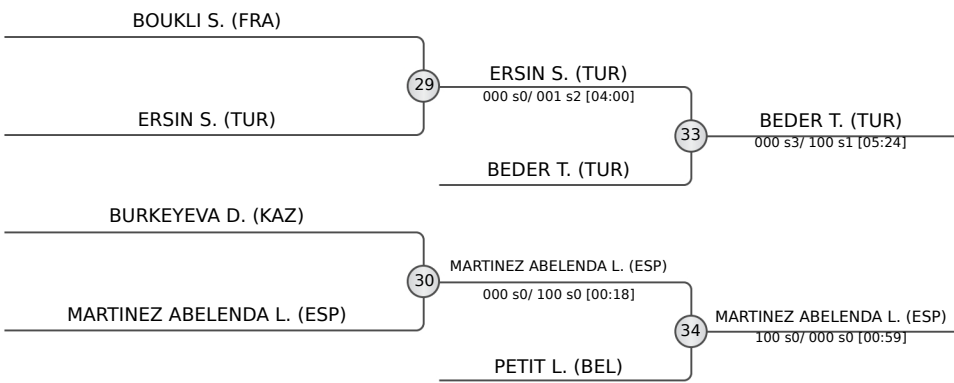

FINAL RESULTS	
1. KOGA Wakana	JPN
2. ZHUANG Wenna	CHN
3. BEDER Tugce	TUR
3. MARTINEZ ABELENDA Laura	ESP
5. ERSIN Sila	TUR
5. PETIT Lois	BEL
7. BOUKLI Shirine	FRA
7. BURKEYEVA Diana	KAZ





Ulaanbaatar Grand Slam 2026

Mongolia, Ulaanbaatar, 19-21 Jun 2026

-52 kg

Seniors (29)

POOL A

	BALLHAUS Mascha	GER
	SHEN Yi-Hsi	TPE
	NUGAEVA Liliia	RUS
	ABE Uta	JPN
	BEATON Evelyn	CAN
	OYUNGEREL Oyunchimeg	MGL
	EASTON Tinka	AUS

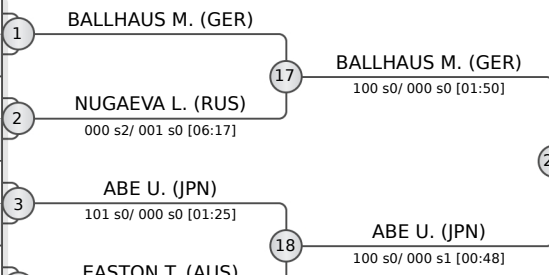

POOL B

	PUPP Reka	HUN
	MAMMADALIYEVA Gultaj	AZE
	ASVESTA Sofia	CYP
	NGUYEN THI Tuyet Han	VIE
	BISHRELT Khorloodoi	UAE
	KIM Minjeong	KOR
	IRAUI Soumiya	MAR
	BAYANMUNKH Urantzaya	MGL

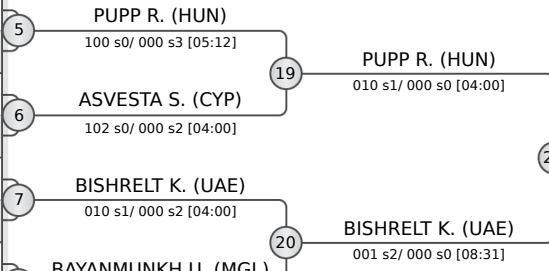

POOL C

	GIUFFRIDA Odette	ITA
	DIMITROVA Gabriela	BUL
	PONT Blandine	FRA
	TORO SOLER Ariane	ESP
	KALETA Aleksandra	POL
	YEREZHEPOVA Aruzhan	KAZ
	TSERENTOGTOKH Gal-Od	MGL

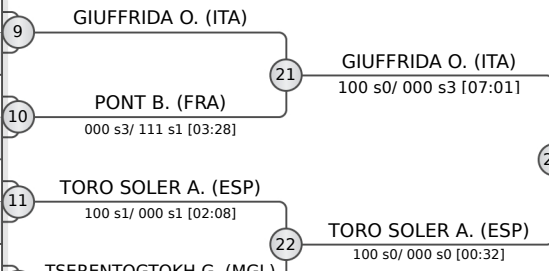

POOL D

	GYERTYAS Roza	HUN
	OMIROVA Narjemal	TKM
	PRIMO Gefen	ISR
	MYAGMARSUREN Nandin-Erdene	MGL
	JANG Seyun	KOR
	LAM THI NGAN Ha	VIE
	VAN KREVEL Naomi	NED

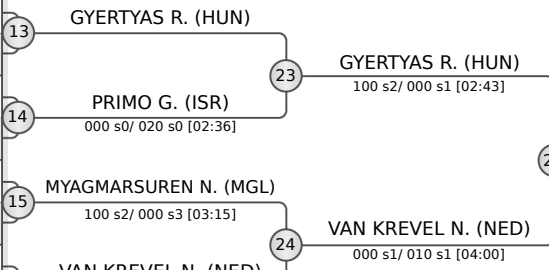

REPECHAGE

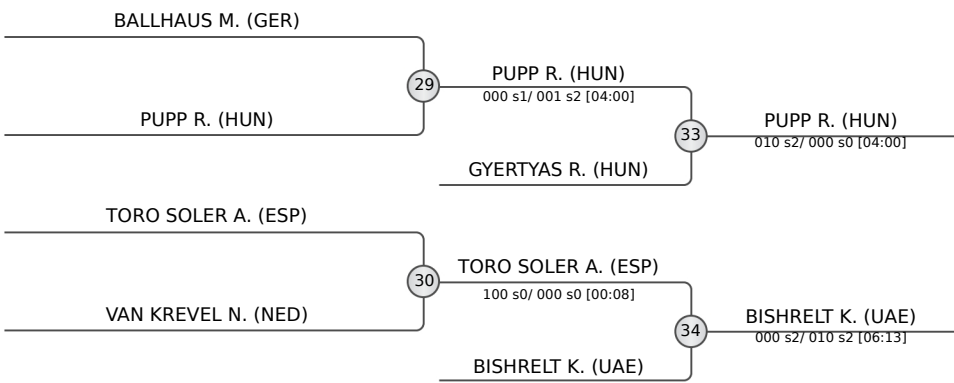

FINAL RESULTS	
1. ABE Uta	JPN
2. GIUFFRIDA Odette	ITA
3. PUPP Reka	HUN
3. BISHRELT Khorloodoi	UAE
5. GYERTYAS Roza	HUN
5. TORO SOLER Ariane	ESP
7. BALLHAUS Mascha	GER
7. VAN KREVEL Naomi	NED





Ulaanbaatar Grand Slam 2026

Mongolia, Ulaanbaatar, 19-21 Jun 2026

-57 kg

Seniors (29)

POOL A

	NELSON LEVY Timna	ISR
	TONIOLO Veronica	ITA
	ELKINA Natalia	RUS
	HUH Mimi	KOR
	MASHBAT Tsendbazar	MGL
	ABDIROVA Dana	KAZ
	PARDAYEVA Maysa	TKM

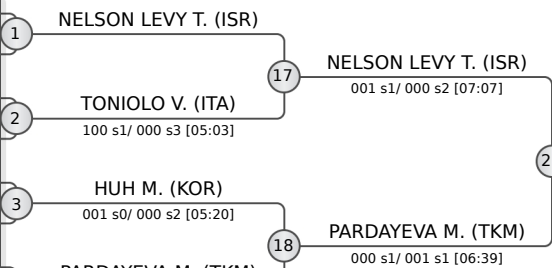

POOL B

	OMORI Akari	JPN
	LKHAGVASUREN Sosorbaram	MGL
	BUDAK Aysenur	TUR
	TAO Yuying	CHN
	TOPRAK Acelya	GBR
	VAN DE MEEBERG Shannon	NED
	LEOPOLD Maya	URU
	MATIKAINEN Pihla	FIN

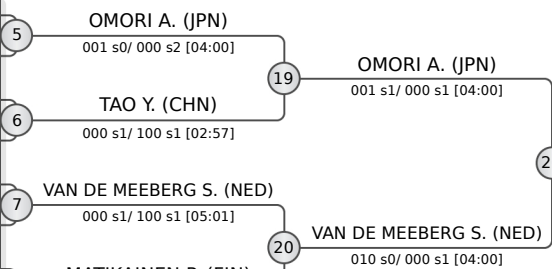

POOL C

	MOKDAR Faiza	FRA
	SHEMESH Inbal	ISR
	ORAZNYAZOVA Medine	TKM
	BALLHAUS Seija	GER
	ENKHBAATAR Nomintuya	MGL
	ZUEVA Irina	RUS
	MUKHANBET Dina	KAZ

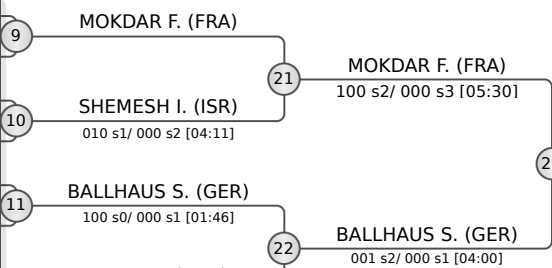

POOL D

	CYSIQUE Sarah Leonie	FRA
	LIU Tzu-Yun	TPE
	BOZKURT Hasret	TUR
	TERBISH Ariunzaya	MGL
	SHIN Yuna	KOR
	WANG Nan	CHN
	SALONEN Pihla	FIN

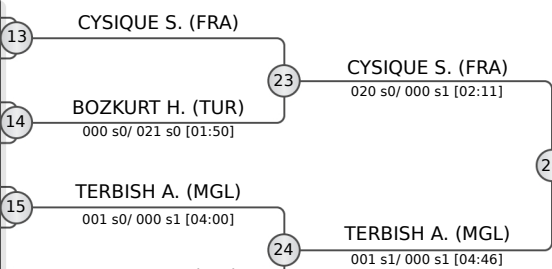

REPECHAGE

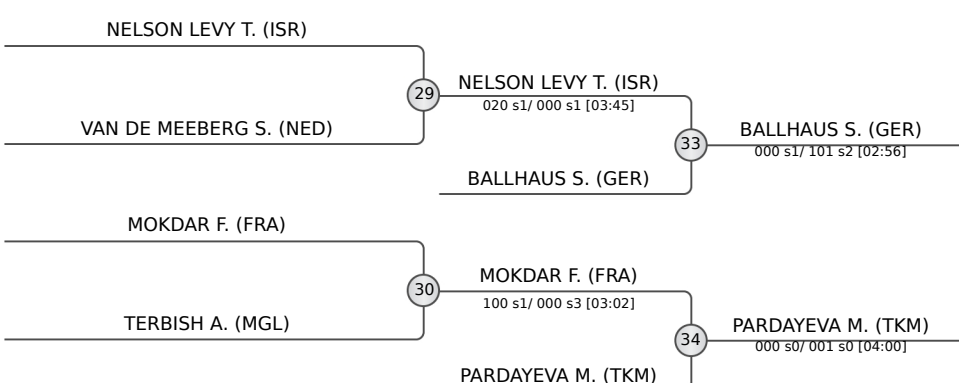

FINAL RESULTS	
1.	OMORI Akari
2.	CYSIQUE Sarah Leonie
3.	BALLHAUS Seija
3.	PARDAYEVA Maysa
5.	NELSON LEVY Timna
5.	MOKDAR Faiza
7.	VAN DE MEEBERG Shannon
7.	TERBISH Ariunzaya





Ulaanbaatar Grand Slam 2026

Mongolia, Ulaanbaatar, 19-21 Jun 2026

-63 kg

Seniors (28)

POOL A

	LKHAGVATOGOO Enkhriilen	MGL
	KIM Yeji	KOR
	KROPSKA Natalia	POL
	PIOVESANA Lubjana	AUT
	SIMIC Nina	CRO
	STOLZE Friederike	GER
	ASSYLKHANOVA Damelya	KAZ

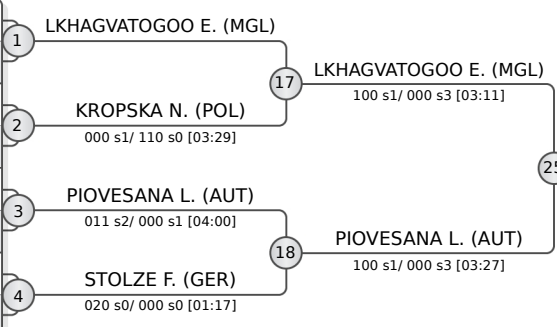

POOL B

	VAN LIESHOUT Joanne	NED
	RUSSO Savita	ITA
	ALIZADA Fidan	AZE
	DEKETER Manon	FRA
	PRIMO Kerem	ISR
	GANKHUYAG Enkhjin	MGL
	GALITSKAIA Kseniia	RUS

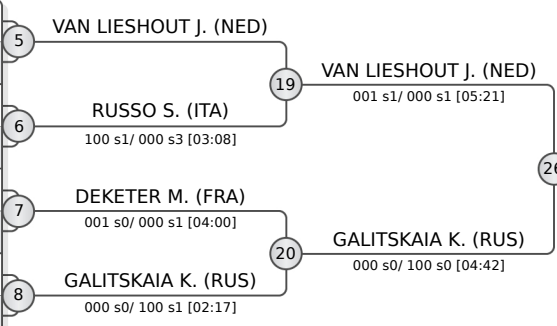

POOL C

	KAJU Haruka	JPN
	KIM Jisu	KOR
	TAIBI Chaimae	MAR
	AVANZATO Carlotta	ITA
	MAKRETSKAYA Yana	BLR
	YUAN Pei Chun	TPE
	KHURELCHULUUN Maralmaa	MGL

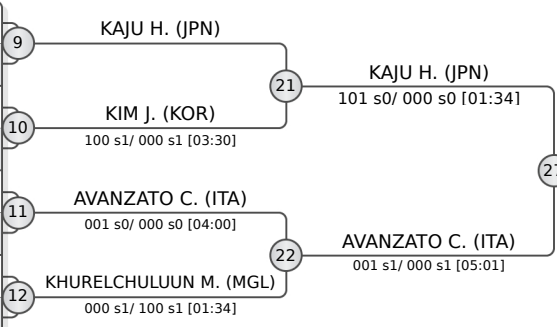

POOL D

	OBERAN Iva	CRO
	YERGALIYEVA Samalay	KAZ
	BAUER Sara-Joy	GER
	BOLD Gankhaich	MGL
	ZACHOVA Renata	CZE
	MANOVA Yoana	BUL
	LILUASHVILI Dali	RUS

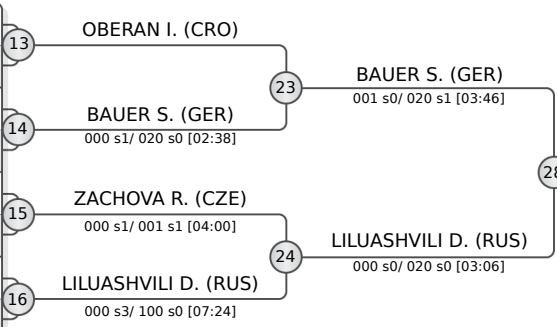

REPECHAGE

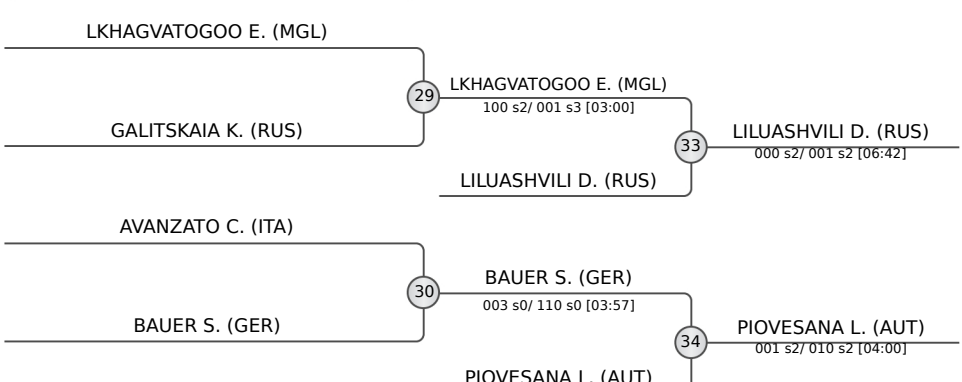

FINAL RESULTS	
1. KAJU Haruka	JPN
2. VAN LIESHOUT Joanne	NED
3. LILUASHVILI Dali	RUS
3. PIOVESANA Lubjana	AUT
5. LKHAGVATOGOO Enkhriilen	MGL
5. BAUER Sara-Joy	GER
7. GALITSKAIA Kseniia	RUS
7. AVANZATO Carlotta	ITA





Ulaanbaatar Grand Slam 2026

Mongolia, Ulaanbaatar, 19-21 Jun 2026

-70 kg

Seniors (33)

POOL A

1	COUGHLAN Aoife (AUS)	33	COUGHLAN A. (AUS)
2	JADAMBA Delger (MGL)	33	COUGHLAN A. (AUS)
3	POLLERES Michaela (AUT)	34	ORUC S. (TUR)
4	ORUC Sinem (TUR)	34	ORUC S. (TUR)
5	STANGHERLIN Giorgia (ITA)	35	STANGHERLIN G. (ITA)
6	SCHUSTER Kaja (SLO)	35	STANGHERLIN G. (ITA)
7	KIM Hyemi (KOR)	36	VAN DIJKE S. (NED)
8	VAN DIJKE Sanne (NED)	36	VAN DIJKE S. (NED)

POOL B

9	BUTKEREIT Miriam (GER)	37	BUTKEREIT M. (GER)
10	MURADOVA Yyldyz (TKM)	37	BUTKEREIT M. (GER)
11	TSUNODA ROUSTANT Ai (ESP)	38	TAIMAZOVA M. (RUS)
12	TAIMAZOVA Madina (RUS)	38	TAIMAZOVA M. (RUS)
13	ERIKSSON Ida (SWE)	39	GOSHEN M. (ISR)
14	GOSHEN Maya (ISR)	39	GOSHEN M. (ISR)
15	GULBANI Nino (GEO)	40	GULBANI N. (GEO)
16	SARANTSETSEG Lkhagvadulam (MGL)	40	GULBANI N. (GEO)

POOL C

17	CVJETKO Lara (CRO)	41	CVJETKO L. (CRO)
18	RUSLANOVA Oguljan (TKM)	41	CVJETKO L. (CRO)
19	KHADBAATAR Buyanjargal (MGL)	42	NOVITSKY A. (ISR)
20	POHL Dena (GER)	42	NOVITSKY A. (ISR)
21	NOVITSKY Adelina (ISR)	43	PEDROTTI I. (ITA)
22	PEDROTTI Irene (ITA)	43	PEDROTTI I. (ITA)
23	TCHANTURIA Mariam (GEO)	44	DE VOOGD M. (NED)
24	AGHAYEVA Sudaba (AZE)	44	DE VOOGD M. (NED)
25	DE VOOGD Margit (NED)	44	DE VOOGD M. (NED)

POOL D

25	TANAKA Shiho (JPN)	45	TANAKA S. (JPN)
26	FIZELOVA Ema (SVK)	45	TANAKA S. (JPN)
27	LEE Yerang (KOR)	46	LEE Y. (KOR)
28	URAN-ULZII Anujin (MGL)	46	LEE Y. (KOR)
29	EME Clemence (FRA)	47	EME C. (FRA)
30	NILSSON Ingrid (SWE)	47	EME C. (FRA)
31	KOREN Nika (SLO)	48	KOREN N. (SLO)
32	LIAO Yu-Jung (TPE)	48	KOREN N. (SLO)

REPECHAGE

61	VAN DIJKE S. (NED)	61	VAN DIJKE S. (NED)
62	GOSHEN M. (ISR)	61	VAN DIJKE S. (NED)
63	CVJETKO L. (CRO)	62	CVJETKO L. (CRO)
64	EME C. (FRA)	62	CVJETKO L. (CRO)
65	VAN DIJKE S. (NED)	65	VAN DIJKE S. (NED)
66	CVJETKO L. (CRO)	66	CVJETKO L. (CRO)
67	BUTKEREIT M. (GER)	66	CVJETKO L. (CRO)

63 COUGHLAN A. (AUS)
100 s2/ 000 s3 [06:47]

57 COUGHLAN A. (AUS)
100 s1/ 000 s2 [03:58]

51 BUTKEREIT M. (GER)
100 s2/ 000 s3 [06:19]

58 BUTKEREIT M. (GER)
100 s0/ 000 s0 [03:09]

52 GOSHEN M. (ISR)
002 s0/ 000 s1 [04:00]

53 CVJETKO L. (CRO)
100 s0/ 000 s3 [06:21]

59 DE VOOGD M. (NED)
000 s0/ 001 s1 [04:00]

54 DE VOOGD M. (NED)
000 s1/ 001 s0 [04:00]

64 TANAKA S. (JPN)
000 s2/ 001 s2 [04:53]

60 TANAKA S. (JPN)
001 s2/ 000 s1 [04:00]

55 TANAKA S. (JPN)
110 s1/ 000 s3 [02:08]

56 EME C. (FRA)
003 s0/ 000 s0 [04:00]

FINAL RESULTS

1. TANAKA Shiho (JPN)
2. COUGHLAN Aoife (AUS)
3. VAN DIJKE Sanne (NED)
4. CVJETKO Lara (CRO)
5. DE VOOGD Margit (NED)
6. BUTKEREIT Miriam (GER)
7. GOSHEN Maya (ISR)
8. EME Clemence (FRA)





Ulaanbaatar Grand Slam 2026

Mongolia, Ulaanbaatar, 19-21 Jun 2026

-78 kg

Seniors (28)

POOL A

	OLEK Anna Monta	GER
	RIABCHENKO Alexandra	RUS
	AILTGUIBAATAR Dulamsuren	MGL
	TCHEUMEO Audrey	FRA
	DUDENAITE Migle Julija	LTU
	GULENAY Tuana	TUR
	HSU WANG Shu Huei	TPE

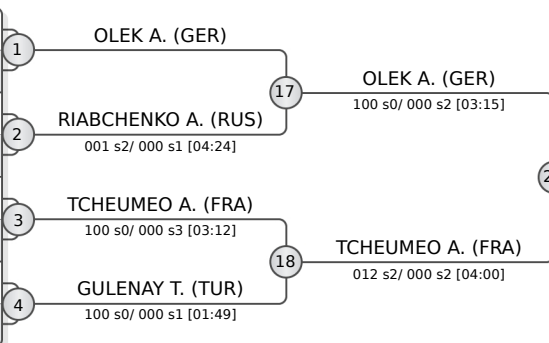

POOL B

	LOBNIK Metka	SLO
	BATSUURI Nyam-Erdene	MGL
	GODBOUT Coralie	CAN
	IKEDA Kurena	JPN
	SWAN Maria	AUS
	VAN HEEMST Yael	NED
	KANTSAVAYA Darya	BLR

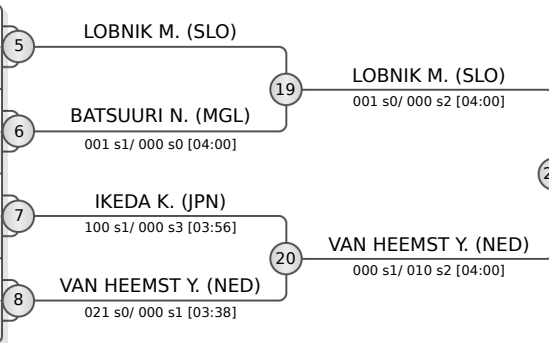

POOL C

	LYTVYENKO Yelyzaveta	UAE
	ZABIC Milica	SRB
	DENGG Elena	AUT
	OLAYA Brenda	COL
	GORGUET-VERANES Maidelines	ROU
	KAMPS Marit	NED
	OTGONBAYAR Khuslen	MGL

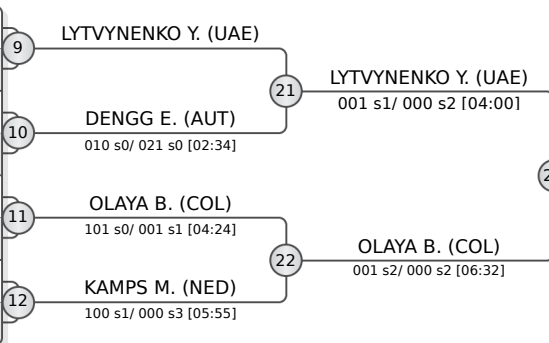

POOL D

	ISSOUFI Kaila	FRA
	MICHAELIDOU Zanet	CYP
	PAVIC Petrunjela	CRO
	BOEHM Alina	GER
	WU Hongtao	CHN
	ERDENEBAT Buyan-Ulzii	MGL
	KRAPU Emma	FIN

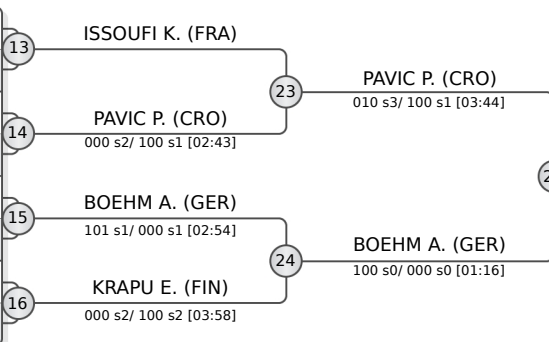

REPECHAGE

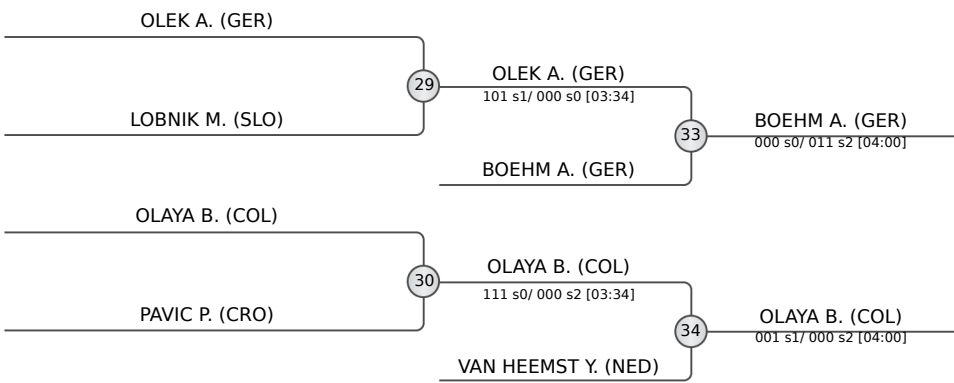

FINAL RESULTS	
1.	LYTVYENKO Yelyzaveta (UAE)
2.	TCHEUMEO Audrey (FRA)
3.	BOEHM Alina (GER)
3.	OLAYA Brenda (COL)
5.	OLEK Anna Monta (GER)
5.	VAN HEEMST Yael (NED)
7.	LOBNIK Metka (SLO)
7.	PAVIC Petrunjela (CRO)





Ulaanbaatar Grand Slam 2026

Mongolia, Ulaanbaatar, 19-21 Jun 2026

+78 kg

Seniors (25)

POOL A

	HERSHKO Raz	ISR
	ENKHBAYAR Enkhzul	MGL
	SU Pin-Tzu	TPE
	ARAI Mao	JPN
	WOJTA Lilli Louise	GER
	BOUVIER Gabrielle	BEL
	RADIC Tina	CRO

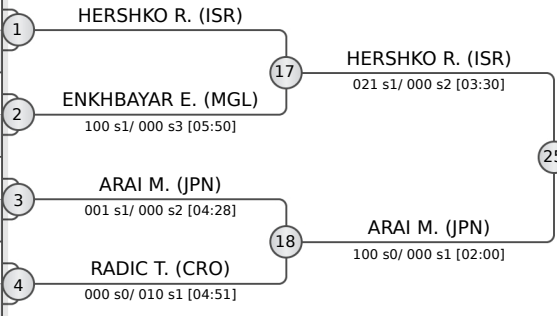

POOL B

	TAVANO Asya	ITA
	BERLIKASH Kamila	KAZ
	STARTSEVA Elis	RUS
	AYIMAN Jinesinuer	CHN
	ENKHMEND Jargalmaa	MGL
	AKTAS Emma-Melis	EST

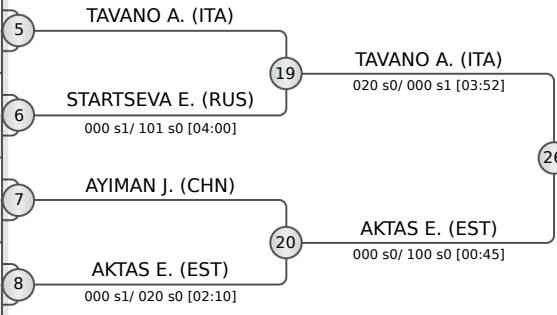

POOL C

	DICKO Romane	FRA
	AMARSAIKHAN Adiyasuren	MGL
	JIA Bingqian	CHN
	CANCAN Celia	FRA
	CHANG Ling Fang	TPE
	SOMKHISHVILI Sophio	GEO

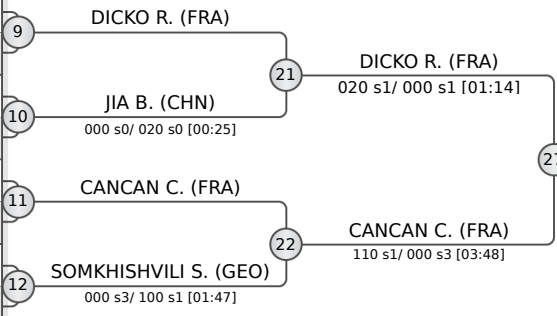

POOL D

	VUKOVIC Helena	CRO
	DAMBADARJAA Nominzul	MGL
	IVANOVA Mariia	RUS
	MISHINER Yuli Alma	ISR
	KAISINOVA Madina	AZE
	RAMAZANOVA Akerke	KAZ

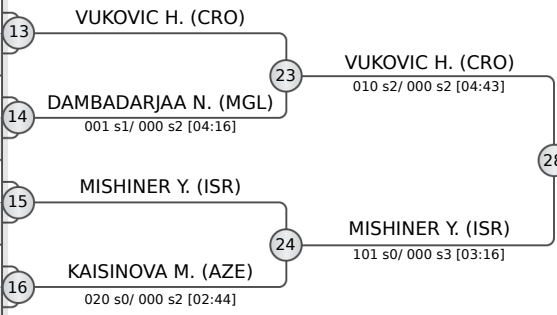

REPECHAGE

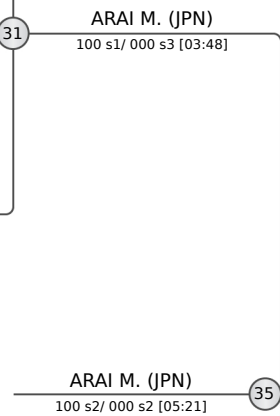
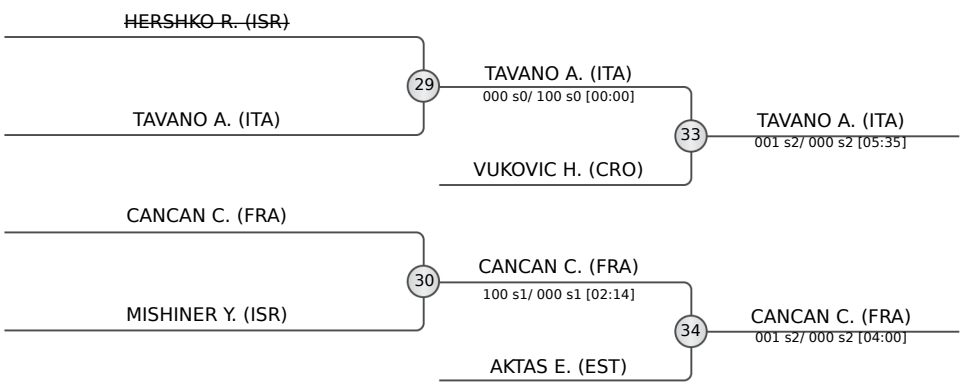

FINAL RESULTS	
1. ARAI Mao	JPN
2. DICKO Romane	FRA
3. TAVANO Asya	ITA
3. CANCAN Celia	FRA
5. VUKOVIC Helena	CRO
5. AKTAS Emma-Melis	EST
7. HERSHKO Raz	ISR
7. MISHINER Yuli Alma	ISR

